

"THIS MEDIA SHOULD NOT BE CONSIDERED A CERTIFIED DOCUMENT."

DATE PREPARED 08-FEB-2018	
ROUTE I-44	STATE MO
DISTRICT SL	SHEET NO. XS1
COUNTY ST. LOUIS	
JOB NO. J613029	
CONTRACT ID.	
PROJECT NO.	
BRIDGE NO.	

DATE	DESCRIPTION

MISSOURI HIGHWAYS AND TRANSPORTATION COMMISSION

105 WEST CAPITOL
 JEFFERSON CITY, MO 65102
 1-888-ASK-MODOT (1-888-275-6636)

JACOBS

JACOBS ENGINEERING GROUP
 501 NORTH BROADWAY
 ST. LOUIS, MISSOURI 63102-2121
 PHONE: (314) 335-4000
 CERTIFICATE OF AUTHORITY #00704

W.B. I-44 CROSS SECTIONS

IF A SEAL IS PRESENT ON THIS SHEET IT HAS BEEN ELECTRONICALLY SEALED AND DATED:

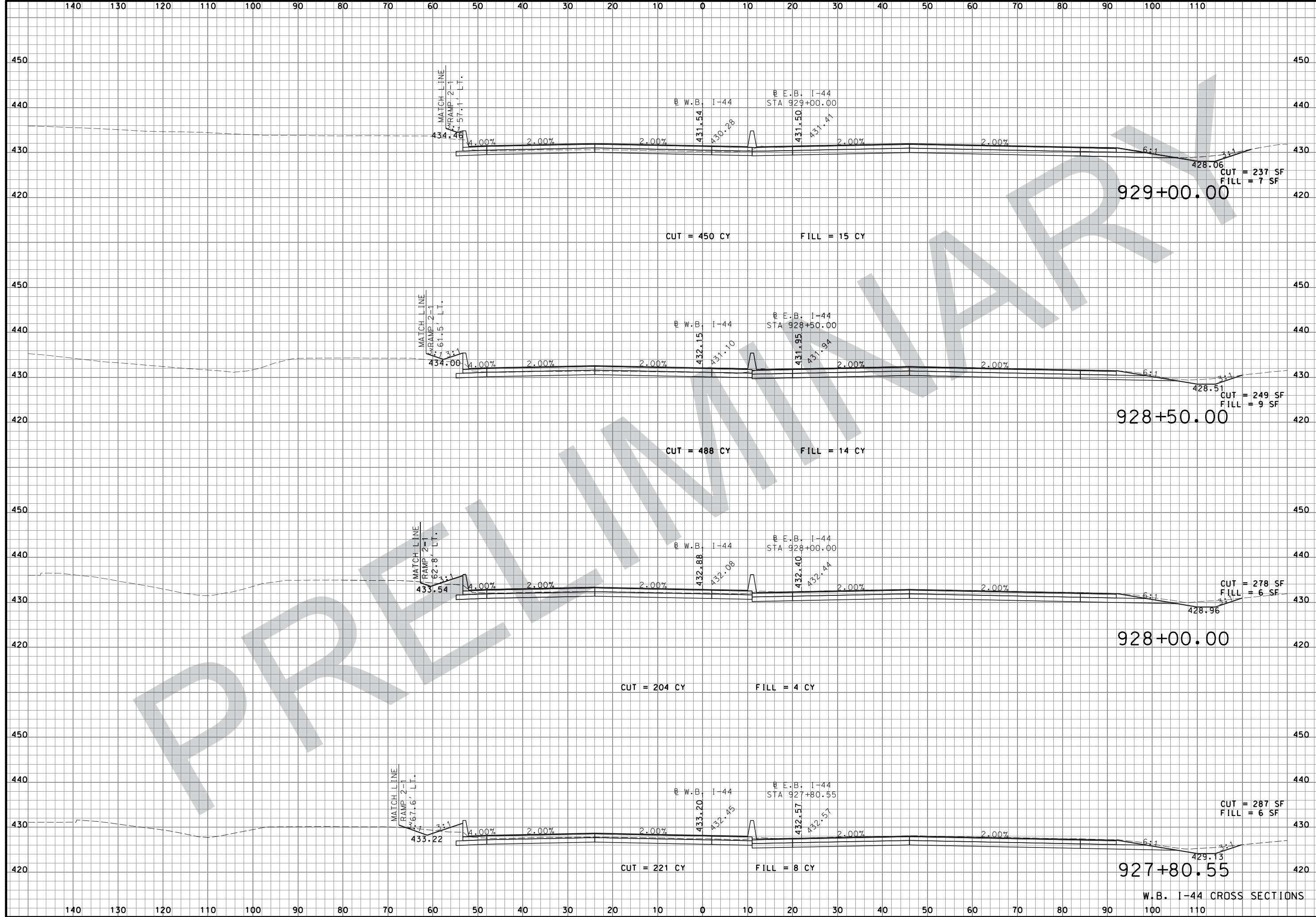

"THIS MEDIA SHOULD NOT BE CONSIDERED A CERTIFIED DOCUMENT."

DATE PREPARED 08-FEB-2018	
ROUTE I-44	STATE MO
DISTRICT SL	SHEET NO. XS2
COUNTY ST. LOUIS	
JOB NO. J613029	
CONTRACT ID.	
PROJECT NO.	
BRIDGE NO.	

DATE	DESCRIPTION

MISSOURI HIGHWAYS AND TRANSPORTATION COMMISSION

105 WEST CAPITOL
JEFFERSON CITY, MO 65102
1-888-ASK-MODOT (1-888-275-6636)

JACOBS ENGINEERING GROUP
501 NORTH BROADWAY
ST. LOUIS, MISSOURI 63102-2121
PHONE: (314) 335-4000
CERTIFICATE OF AUTHORITY #00704

W.B. I-44 CROSS SECTIONS

IF A SEAL IS PRESENT ON THIS SHEET IT HAS BEEN ELECTRONICALLY SEALED AND DATED:

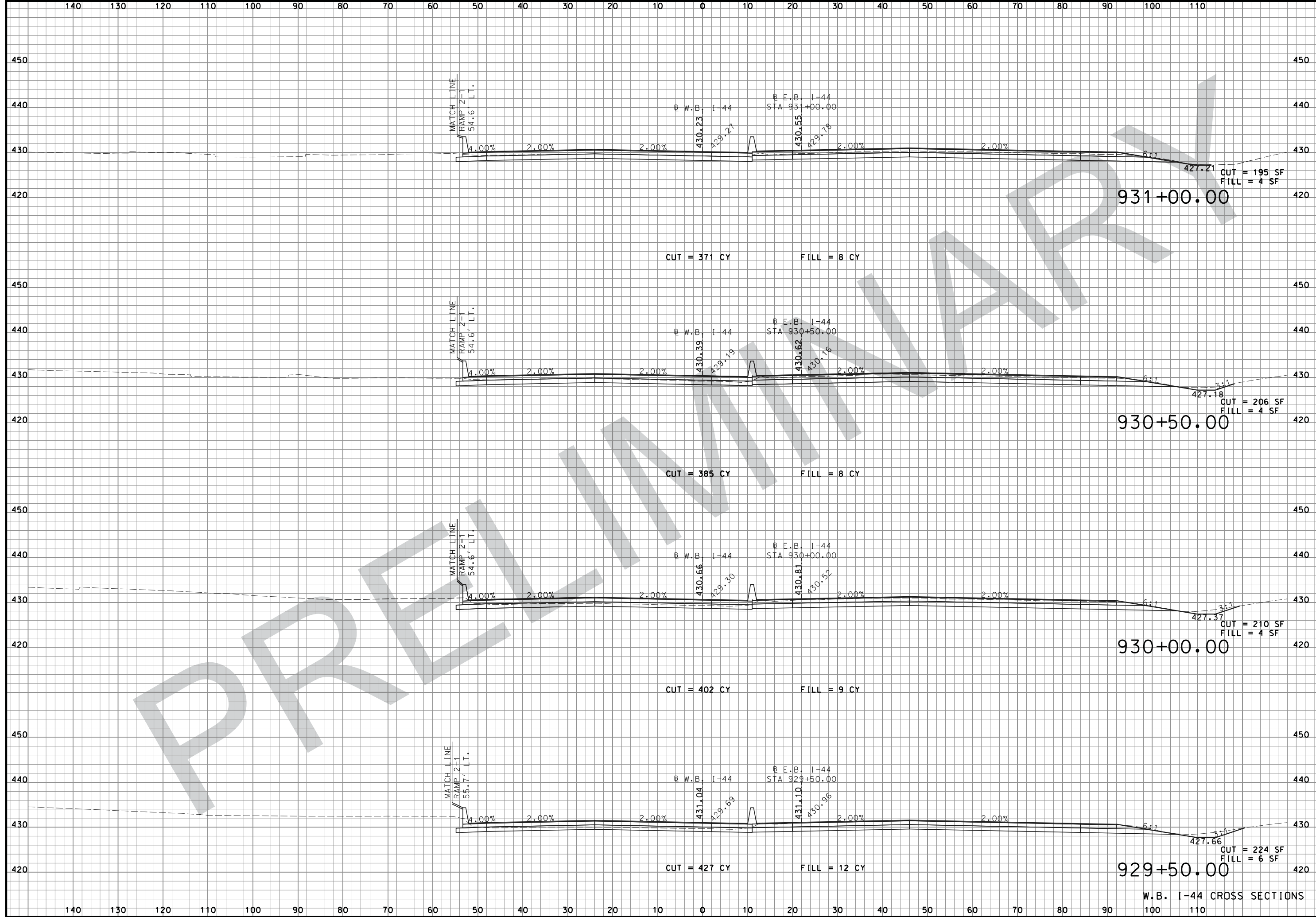

"THIS MEDIA SHOULD NOT BE CONSIDERED A CERTIFIED DOCUMENT."

DATE PREPARED: 08-FEB-2018

ROUTE: I-44 STATE: MO

DISTRICT: SL SHEET NO.: XS3

COUNTY: ST. LOUIS

JOB NO.: J613029

CONTRACT ID.:

PROJECT NO.:

BRIDGE NO.:

DESCRIPTION	DATE

MISSOURI HIGHWAYS AND TRANSPORTATION COMMISSION

MODOT

105 WEST CAPITOL
JEFFERSON CITY, MO 65102
1-888-ASK-MODOT (1-888-275-6636)

JACOBS

JACOBS ENGINEERING GROUP
501 NORTH BROADWAY
ST. LOUIS, MISSOURI 63102-2121
PHONE: (314) 335-4000
CERTIFICATE OF AUTHORITY #00704

IF A SEAL IS PRESENT ON THIS SHEET IT HAS BEEN ELECTRONICALLY SEALED AND DATED:

W.B. I-44 CROSS SECTIONS

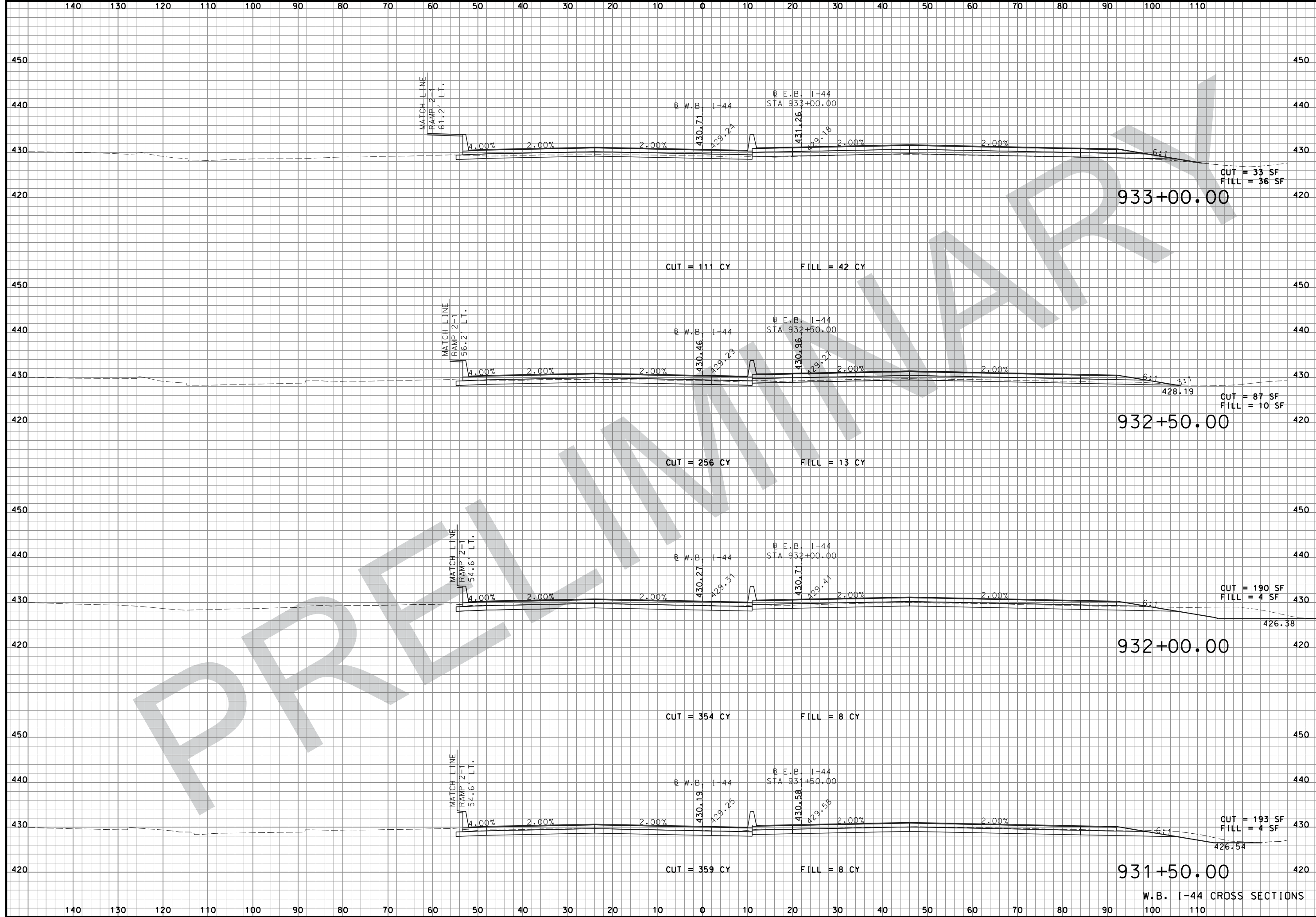

"THIS MEDIA SHOULD NOT BE CONSIDERED A CERTIFIED DOCUMENT."

DATE PREPARED 08-FEB-2018	
ROUTE I-44	STATE MO
DISTRICT SL	SHEET NO. XS4
COUNTY ST. LOUIS	
JOB NO. J613029	
CONTRACT ID.	
PROJECT NO.	
BRIDGE NO.	

DATE	DESCRIPTION

MISSOURI HIGHWAYS AND TRANSPORTATION COMMISSION

JACOBS

JACOBS ENGINEERING GROUP
501 NORTH BROADWAY
ST. LOUIS, MISSOURI 63102-2121
PHONE: (314) 335-4000
CERTIFICATE OF AUTHORITY #00704

MISSOURI DOT

105 WEST CAPITOL
JEFFERSON CITY, MO 65102
1-888-ASK-MODOT (1-888-275-6636)

W.B. I-44 CROSS SECTIONS

IF A SEAL IS PRESENT ON THIS SHEET IT HAS BEEN ELECTRONICALLY SEALED AND DATED:

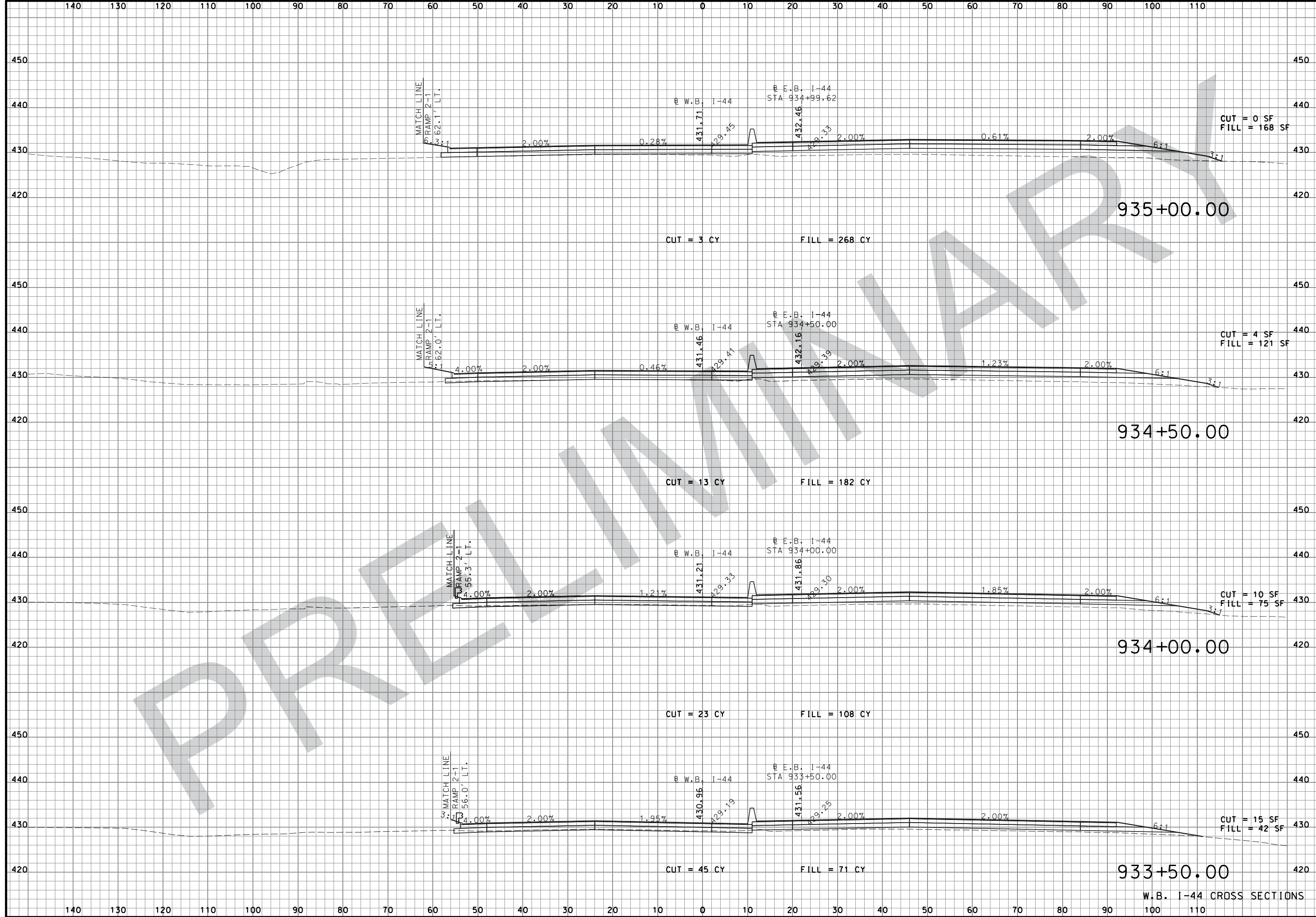

"THIS MEDIA SHOULD NOT BE CONSIDERED A CERTIFIED DOCUMENT."

DATE PREPARED: 08-FEB-2018

ROUTE: I-44 STATE: MO

DISTRICT: SL SHEET NO.: XS5

COUNTY: ST. LOUIS

JOB NO.: J613029

CONTRACT ID.:

PROJECT NO.:

BRIDGE NO.:

DESCRIPTION	DATE

MISSOURI HIGHWAYS AND TRANSPORTATION COMMISSION

MODOT

105 WEST CAPITOL
JEFFERSON CITY, MO 65102
1-888-ASK-MODOT (1-888-275-6636)

JACOBS

JACOBS ENGINEERING GROUP
501 NORTH BROADWAY
ST. LOUIS, MISSOURI 63102-2121
PHONE: (314) 335-4000
CERTIFICATE OF AUTHORITY #00704

W.B. I-44 CROSS SECTIONS

IF A SEAL IS PRESENT ON THIS SHEET IT HAS BEEN ELECTRONICALLY SEALED AND DATED:

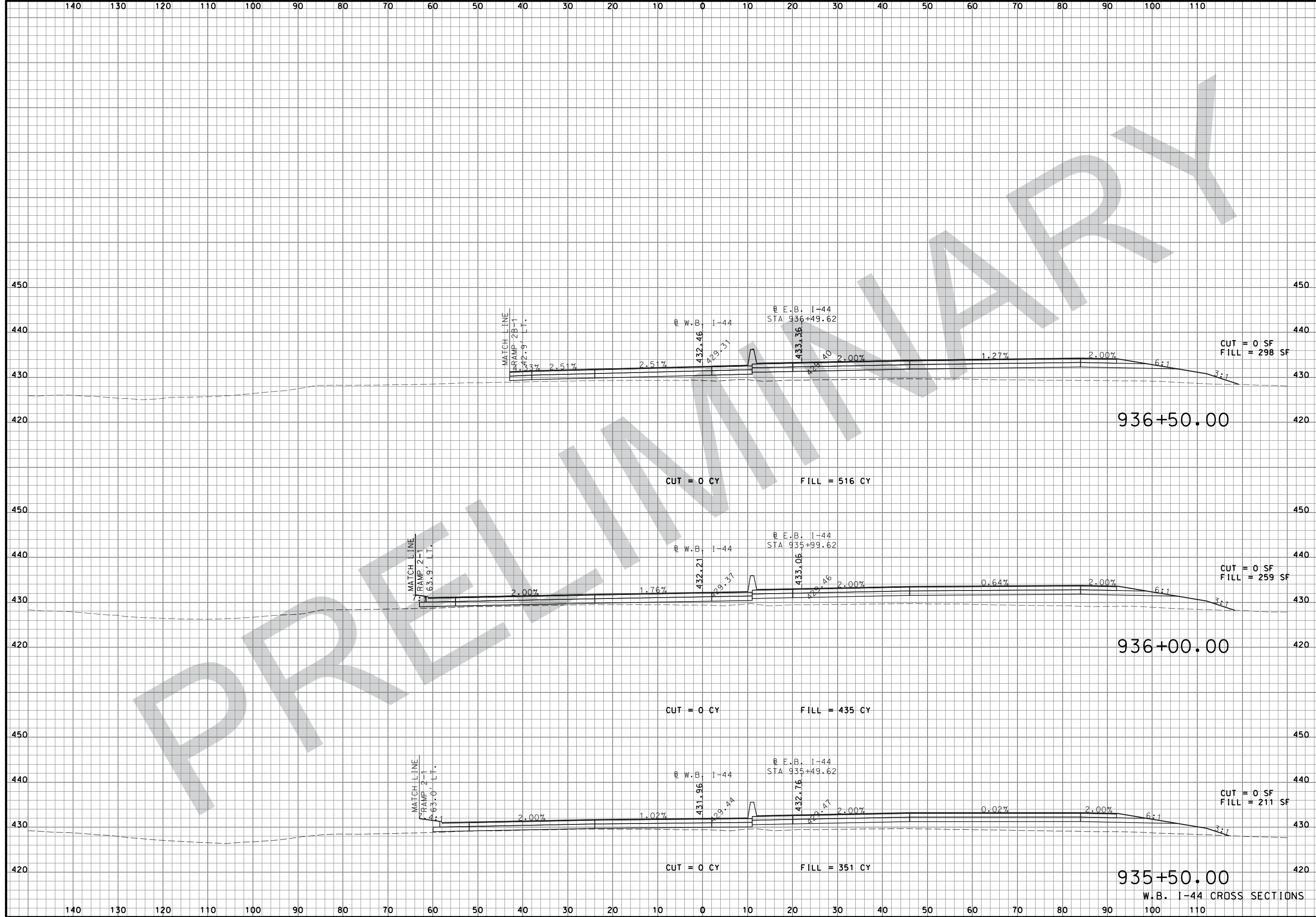



"THIS MEDIA SHOULD NOT BE CONSIDERED A CERTIFIED DOCUMENT."

DATE PREPARED 08-FEB-2018	
ROUTE I-44	STATE MO
DISTRICT SL	SHEET NO. XS6
COUNTY ST. LOUIS	
JOB NO. J613029	
CONTRACT ID.	
PROJECT NO.	
BRIDGE NO.	

DESCRIPTION	DATE

MISSOURI HIGHWAYS AND TRANSPORTATION COMMISSION

 105 WEST CAPITOL
 JEFFERSON CITY, MO 65102
 1-888-ASK-MODOT (1-888-275-6636)

 JACOBS ENGINEERING GROUP
 501 NORTH BROADWAY
 ST. LOUIS, MISSOURI 63102-2121
 PHONE: (314) 335-4000
 CERTIFICATE OF AUTHORITY #00704

W.B. I-44 CROSS SECTIONS

IF A SEAL IS PRESENT ON THIS SHEET IT HAS BEEN ELECTRONICALLY SEALED AND DATED:

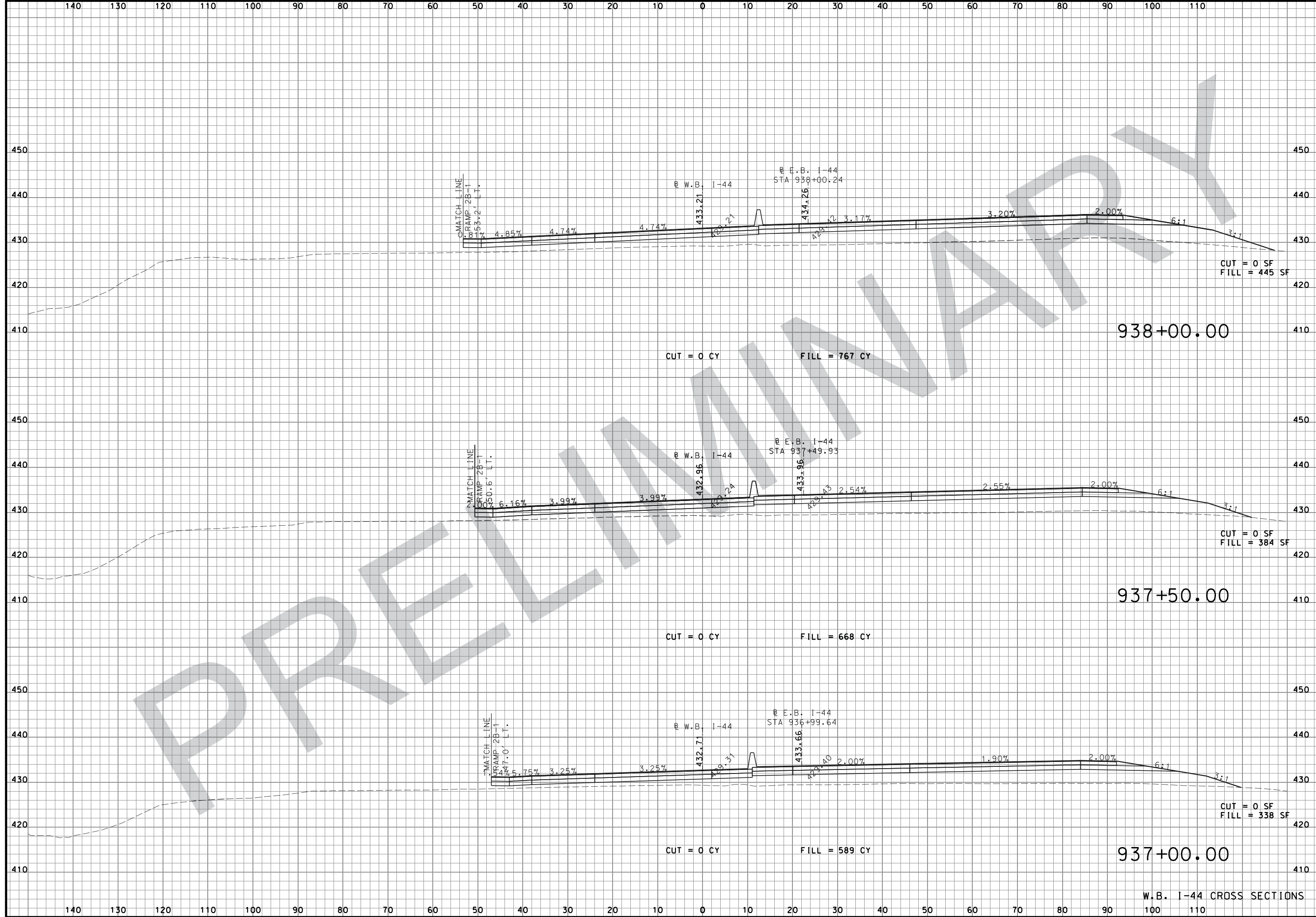

"THIS MEDIA SHOULD NOT BE CONSIDERED A CERTIFIED DOCUMENT."

DATE PREPARED
08-FEB-2018

ROUTE	STATE
I-44	MO
DISTRICT	SHEET NO.
SL	XS7

COUNTY
ST. LOUIS

JOB NO.
J613029

CONTRACT ID.

PROJECT NO.

BRIDGE NO.

DATE	DESCRIPTION

MISSOURI HIGHWAYS AND TRANSPORTATION COMMISSION

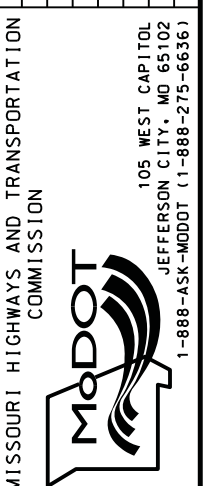

JACOBS

JACOBS ENGINEERING GROUP
 501 NORTH BROADWAY
 ST. LOUIS, MISSOURI 63102-2121
 PHONE: (314) 335-4000
 CERTIFICATE OF AUTHORITY #00704

IF A SEAL IS PRESENT ON THIS SHEET IT HAS BEEN ELECTRONICALLY SEALED AND DATED:

W.B. I-44 CROSS SECTIONS

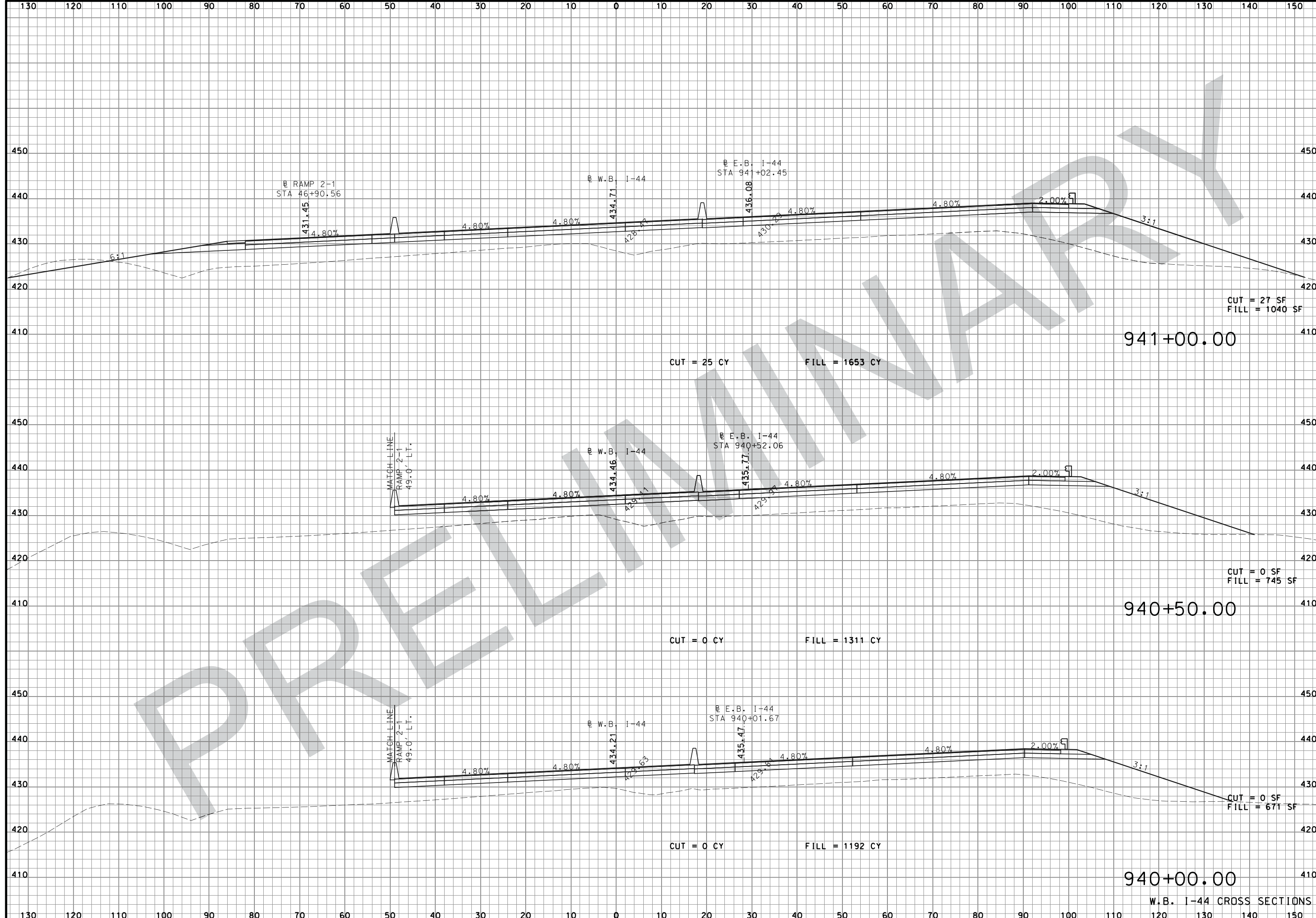

"THIS MEDIA SHOULD NOT BE CONSIDERED A CERTIFIED DOCUMENT."

DATE PREPARED
08-FEB-2018

ROUTE STATE
I-44 MO

DISTRICT SHEET NO.
SL XS9

COUNTY
ST. LOUIS

JOB NO.
J613029

CONTRACT ID.

PROJECT NO.

BRIDGE NO.

DATE	DESCRIPTION

MISSOURI HIGHWAYS AND TRANSPORTATION COMMISSION

105 WEST CAPITOL
JEFFERSON CITY, MO 65102
1-888-ASK-MODOT (1-888-275-6636)

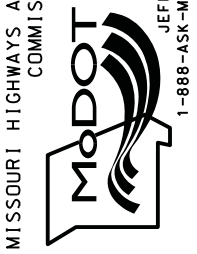

JACOBS
JACOBS ENGINEERING GROUP
501 NORTH BROADWAY
ST. LOUIS, MISSOURI 63102-2121
PHONE: (314) 335-4000
CERTIFICATE OF AUTHORITY #00704

IF A SEAL IS PRESENT ON THIS SHEET IT HAS BEEN ELECTRONICALLY SEALED AND DATED:

W.B. I-44 CROSS SECTIONS

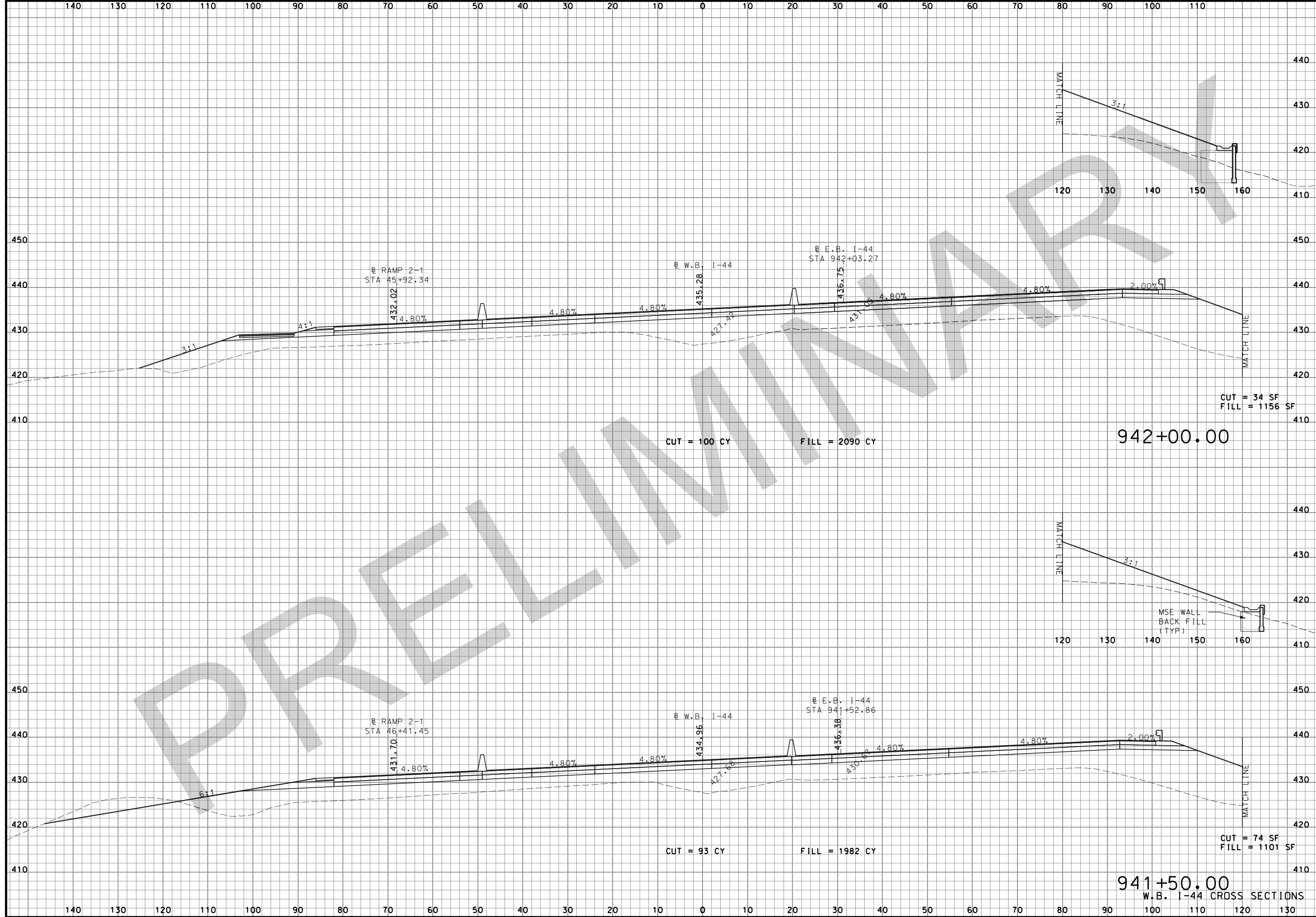

"THIS MEDIA SHOULD NOT BE CONSIDERED A CERTIFIED DOCUMENT."

DATE PREPARED 08-FEB-2018	
ROUTE I-44	STATE MO
DISTRICT SL	SHEET NO. XS10
COUNTY ST. LOUIS	
JOB NO. J613029	
CONTRACT ID.	
PROJECT NO.	
BRIDGE NO.	

DATE	DESCRIPTION

MISSOURI HIGHWAYS AND TRANSPORTATION COMMISSION

MODOT
 105 WEST CAPITOL
 JEFFERSON CITY, MO 65102
 1-888-ASK-MODOT (1-888-275-6636)

JACOBS™

JACOBS ENGINEERING GROUP
 501 NORTH BROADWAY
 ST. LOUIS, MISSOURI 63102-2121
 PHONE: (314) 335-4000
 CERTIFICATE OF AUTHORITY #00704

W.B. I-44 CROSS SECTIONS

IF A SEAL IS PRESENT ON THIS SHEET IT HAS BEEN ELECTRONICALLY SEALED AND DATED:

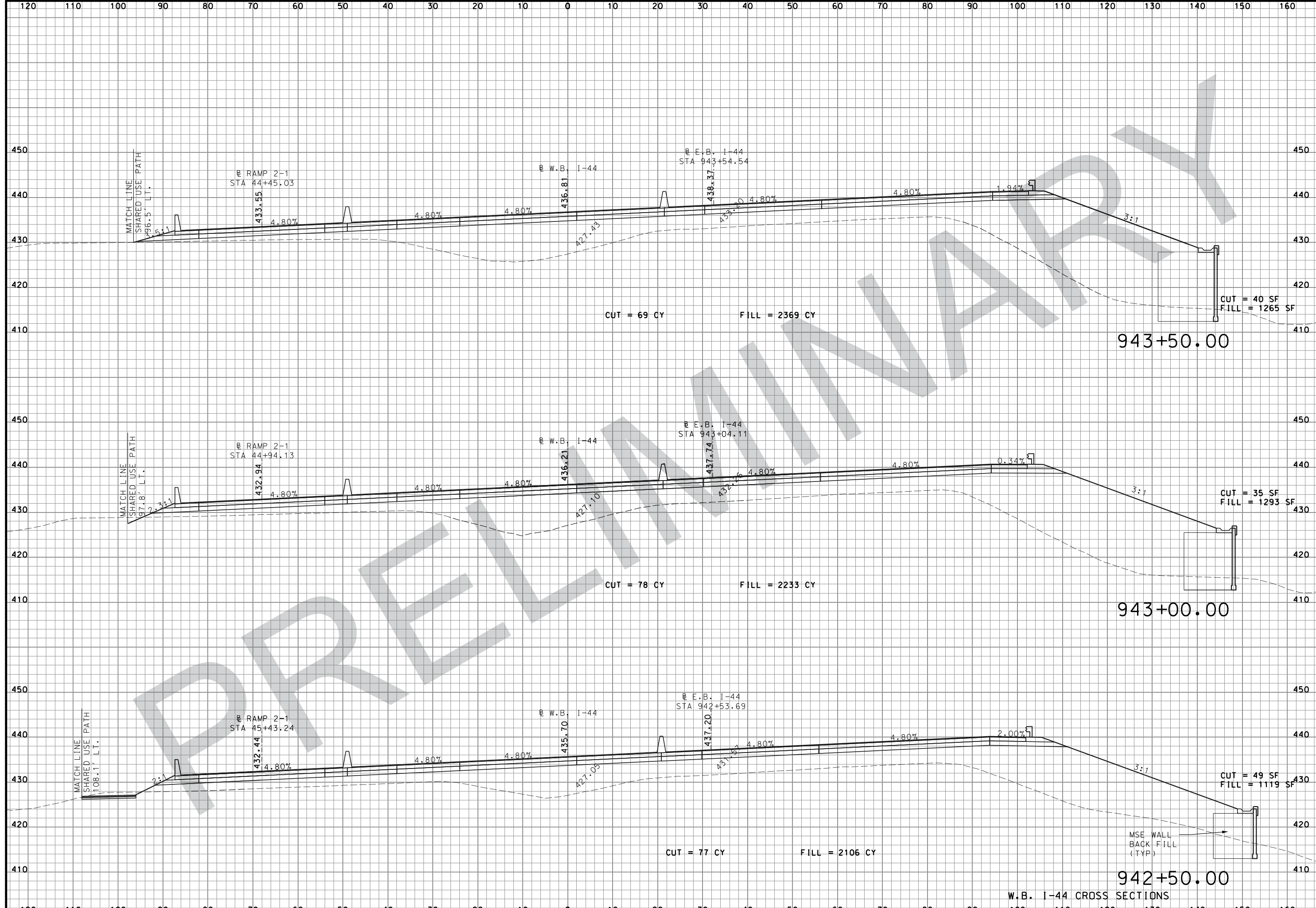

"THIS MEDIA SHOULD NOT BE CONSIDERED A CERTIFIED DOCUMENT."

DATE PREPARED 08-FEB-2018	
ROUTE I-44	STATE MO
DISTRICT SL	SHEET NO. XS11
COUNTY ST. LOUIS	
JOB NO. J613029	
CONTRACT ID.	
PROJECT NO.	
BRIDGE NO.	

DATE	DESCRIPTION

MISSOURI HIGHWAYS AND TRANSPORTATION COMMISSION

105 WEST CAPITOL
JEFFERSON CITY, MO 65102
1-888-ASK-MODOT (1-888-275-6636)

JACOBS ENGINEERING GROUP
501 NORTH BROADWAY
ST. LOUIS, MISSOURI 63102-2121
PHONE: (314) 335-4000
CERTIFICATE OF AUTHORITY #00704

W.B. I-44 CROSS SECTIONS

IF A SEAL IS PRESENT ON THIS SHEET IT HAS BEEN ELECTRONICALLY SEALED AND DATED:

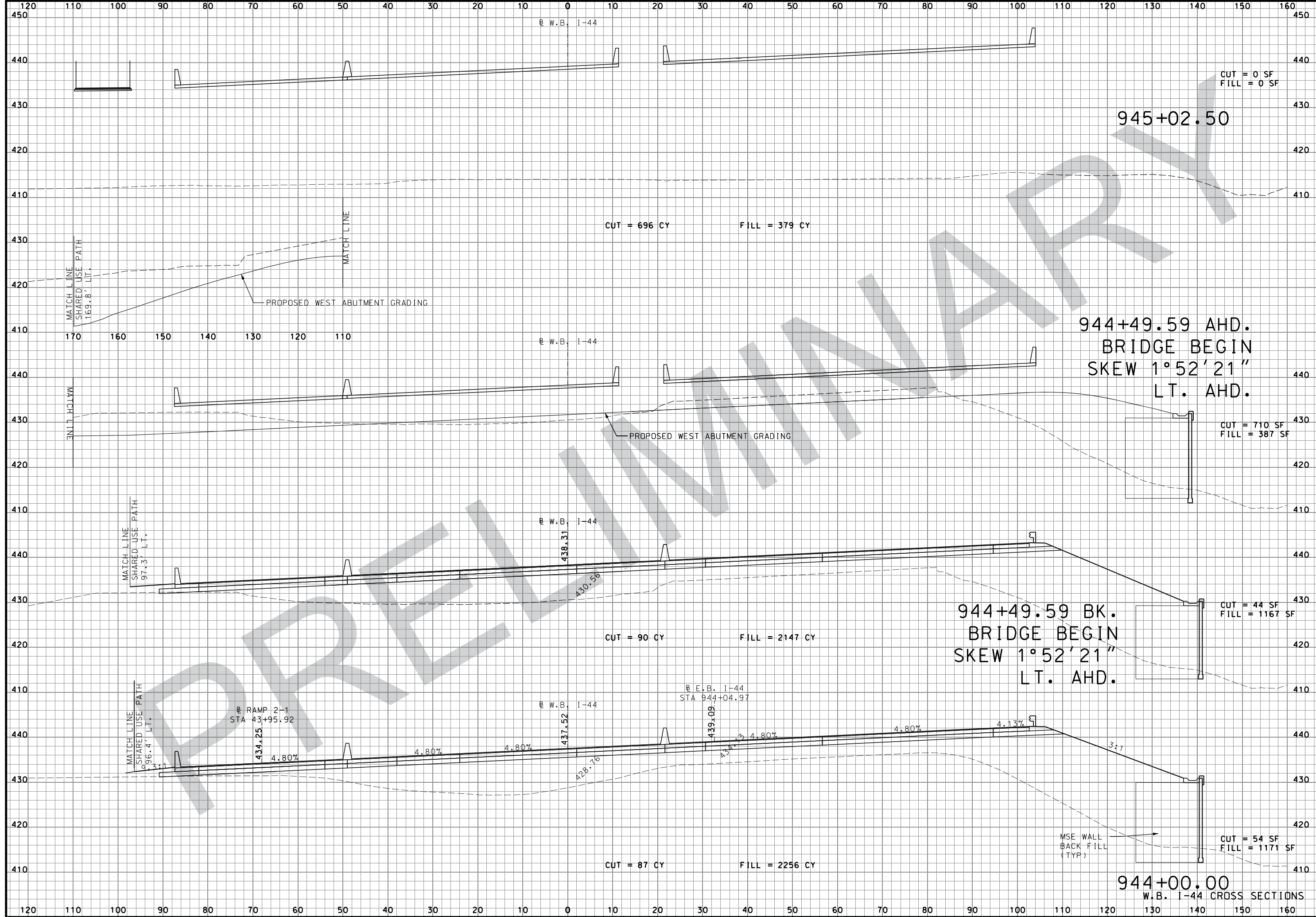

"THIS MEDIA SHOULD NOT BE CONSIDERED A CERTIFIED DOCUMENT."

DATE PREPARED 08-FEB-2018	
ROUTE I-44	STATE MO
DISTRICT SL	SHEET NO. XS12
COUNTY ST. LOUIS	
JOB NO. J613029	
CONTRACT ID.	
PROJECT NO.	
BRIDGE NO.	

DATE	DESCRIPTION

MISSOURI HIGHWAYS AND TRANSPORTATION COMMISSION

105 WEST CAPITOL
JEFFERSON CITY, MO 65102
1-888-ASK-MODOT (1-888-275-6636)

JACOBS ENGINEERING GROUP
501 NORTH BROADWAY
ST. LOUIS, MISSOURI 63102-2121
PHONE: (314) 335-4000
CERTIFICATE OF AUTHORITY #00704

IF A SEAL IS PRESENT ON THIS SHEET IT HAS BEEN ELECTRONICALLY SEALED AND DATED:

944+00.00
W.B. I-44 CROSS SECTIONS

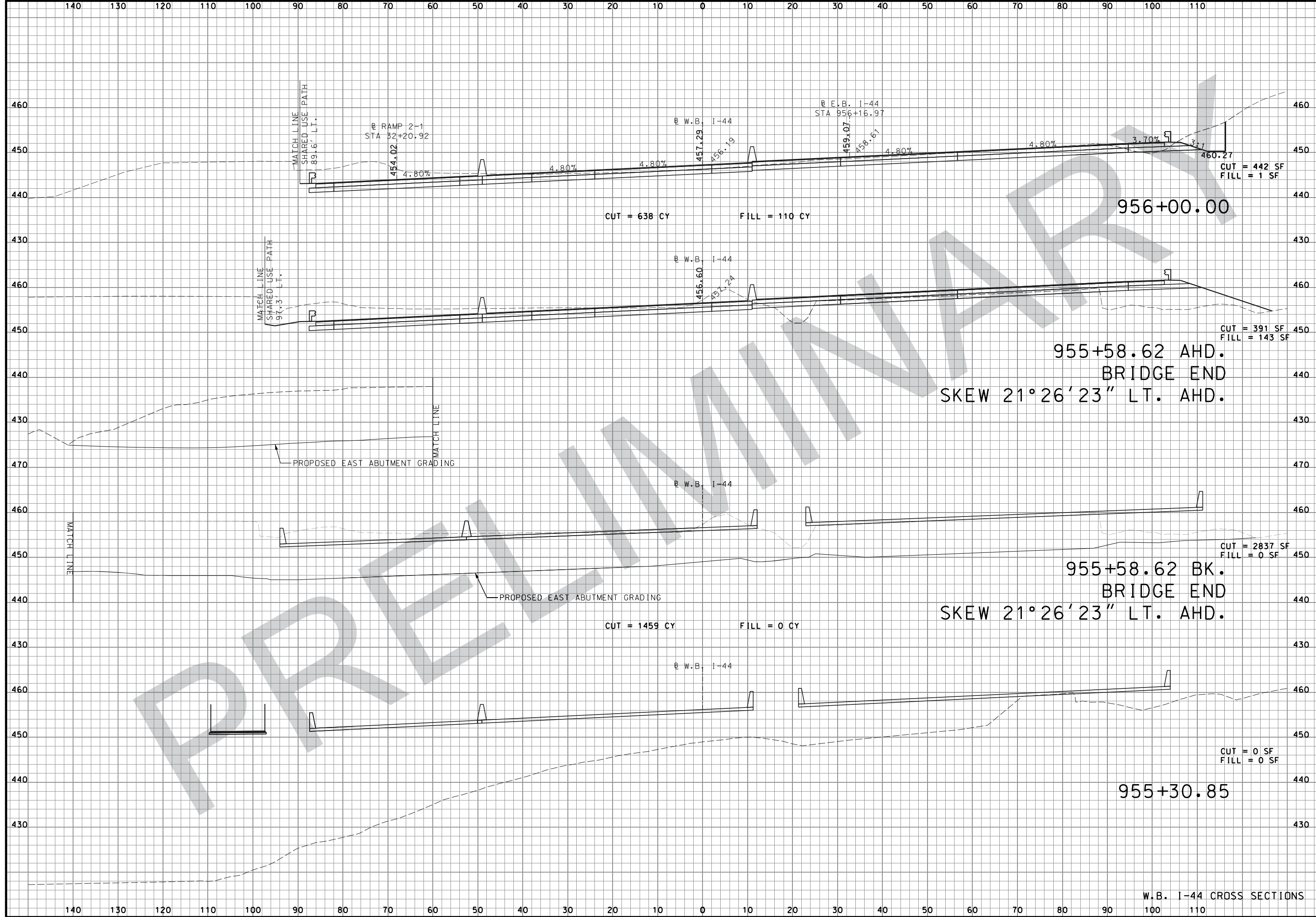

"THIS MEDIA SHOULD NOT BE CONSIDERED A CERTIFIED DOCUMENT."

DATE PREPARED 08-FEB-2018	
ROUTE I-44	STATE MO
DISTRICT SL	SHEET NO. XS13
COUNTY ST. LOUIS	
JOB NO. J613029	
CONTRACT ID.	
PROJECT NO.	
BRIDGE NO.	

DATE	DESCRIPTION

MISSOURI HIGHWAYS AND TRANSPORTATION COMMISSION

MODOT

105 WEST CAPITOL
JEFFERSON CITY, MO 65102
1-888-ASK-MODOT (1-888-275-6636)

JACOBS

JACOBS ENGINEERING GROUP
501 NORTH BROADWAY
ST. LOUIS, MISSOURI 63102-2121
PHONE: (314) 335-4000
CERTIFICATE OF AUTHORITY #00704

W.B. I-44 CROSS SECTIONS

IF A SEAL IS PRESENT ON THIS SHEET IT HAS BEEN ELECTRONICALLY SEALED AND DATED:

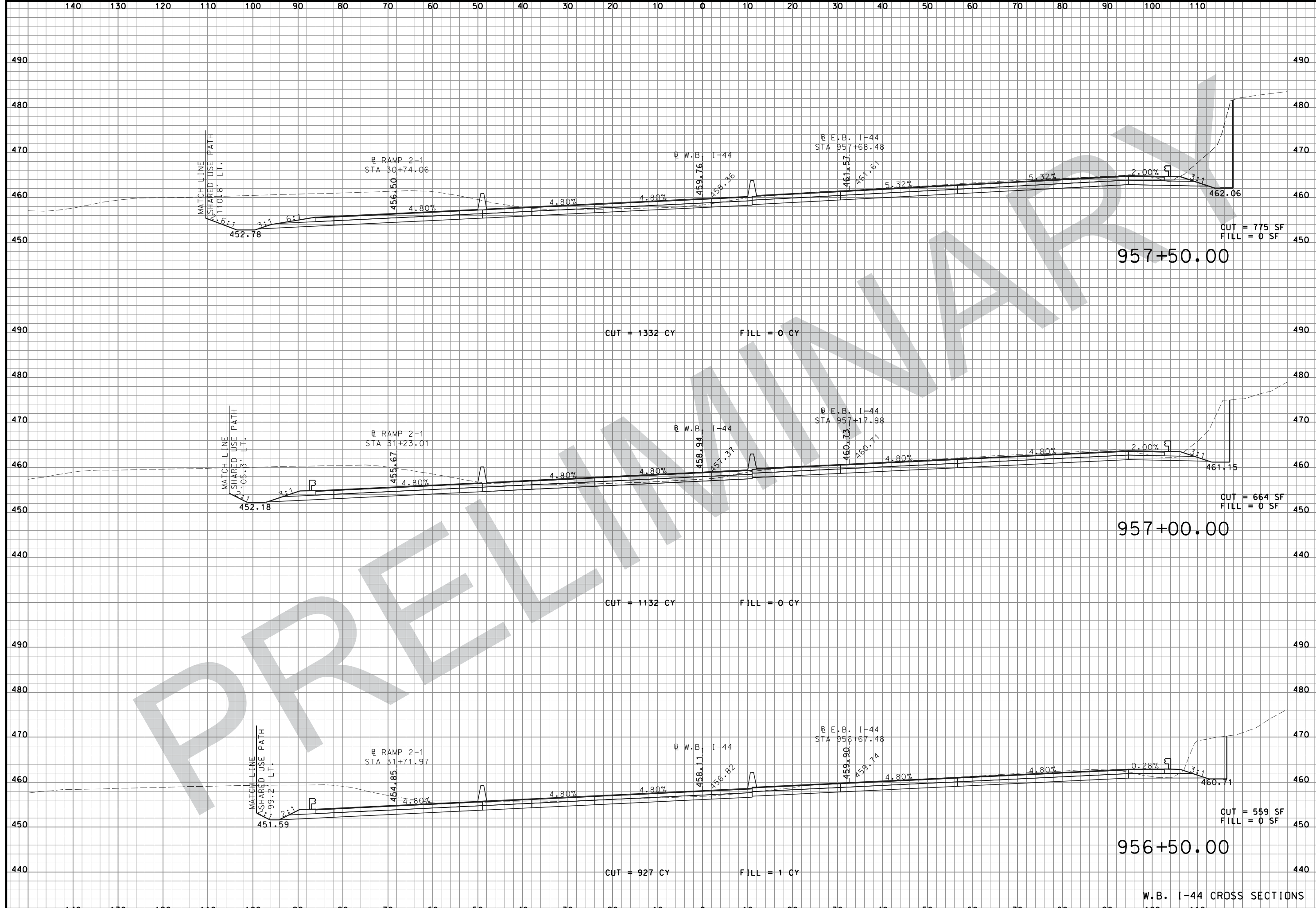

"THIS MEDIA SHOULD NOT BE CONSIDERED A CERTIFIED DOCUMENT."

DATE PREPARED 08-FEB-2018	
ROUTE I-44	STATE MO
DISTRICT SL	SHEET NO. XS14
COUNTY ST. LOUIS	
JOB NO. J613029	
CONTRACT ID.	
PROJECT NO.	
BRIDGE NO.	

DATE	DESCRIPTION

MISSOURI HIGHWAYS AND TRANSPORTATION COMMISSION

105 WEST CAPITOL
JEFFERSON CITY, MO 65102
1-888-ASK-MODOT (1-888-275-6636)

JACOBS ENGINEERING GROUP
501 NORTH BROADWAY
ST. LOUIS, MISSOURI 63102-2121
PHONE: (314) 335-4000
CERTIFICATE OF AUTHORITY #00704

W.B. I-44 CROSS SECTIONS

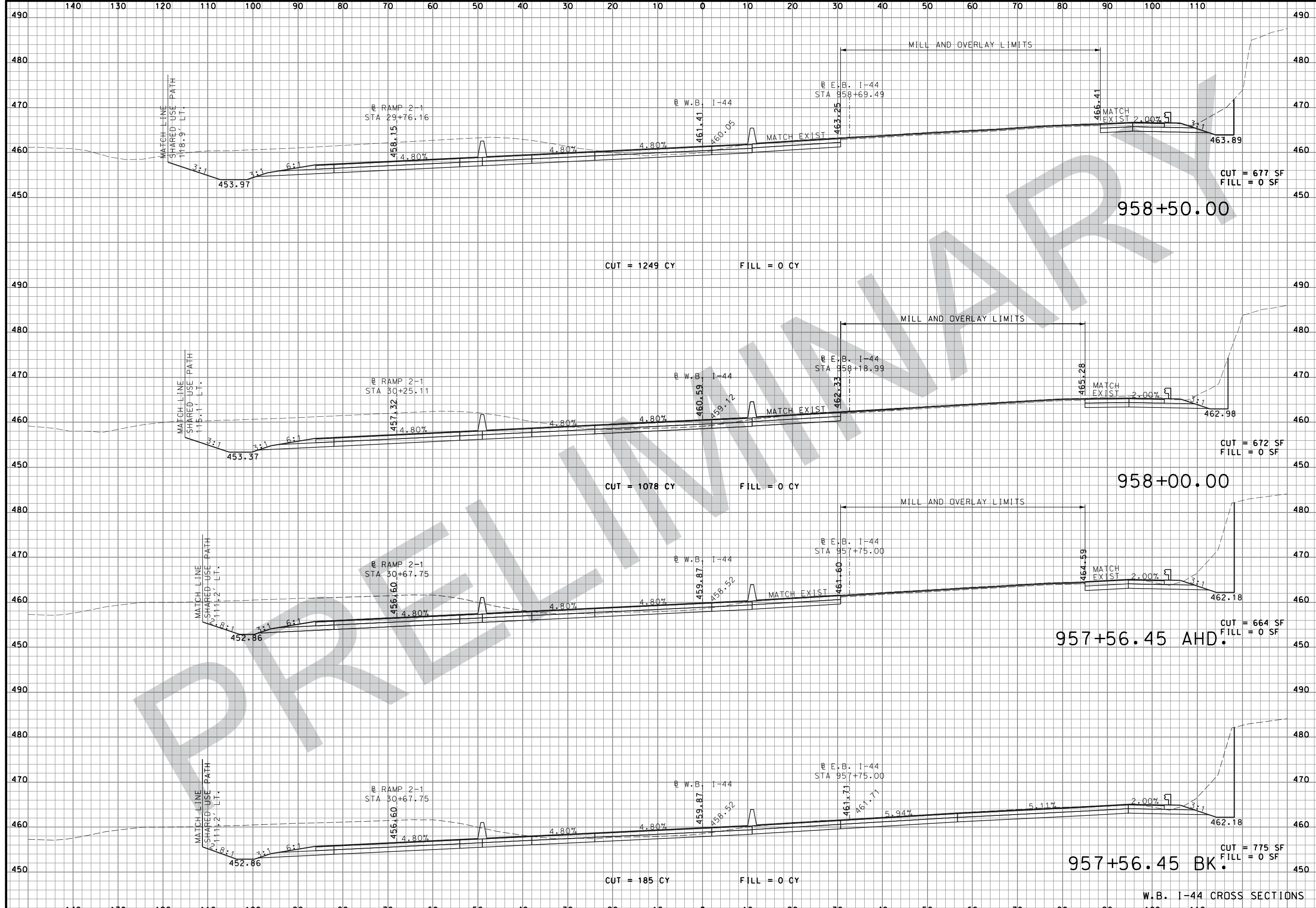



"THIS MEDIA SHOULD NOT BE CONSIDERED A CERTIFIED DOCUMENT."

DATE PREPARED 08-FEB-2018	
ROUTE I-44	STATE MO
DISTRICT SL	SHEET NO. XS15
COUNTY ST. LOUIS	
JOB NO. J613029	
CONTRACT ID.	
PROJECT NO.	
BRIDGE NO.	

DATE	DESCRIPTION

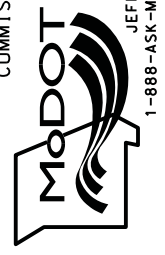
MISSOURI HIGHWAYS AND TRANSPORTATION COMMISSION

 105 WEST CAPITOL
 JEFFERSON CITY, MO 65102
 1-888-ASK-MODOT (1-888-275-6636)

 JACOBS ENGINEERING GROUP
 501 NORTH BROADWAY
 ST. LOUIS, MISSOURI 63102-2121
 PHONE: (314) 335-4000
 CERTIFICATE OF AUTHORITY #00704

W.B. I-44 CROSS SECTIONS

IF A SEAL IS PRESENT ON THIS SHEET IT HAS BEEN ELECTRONICALLY SEALED AND DATED:

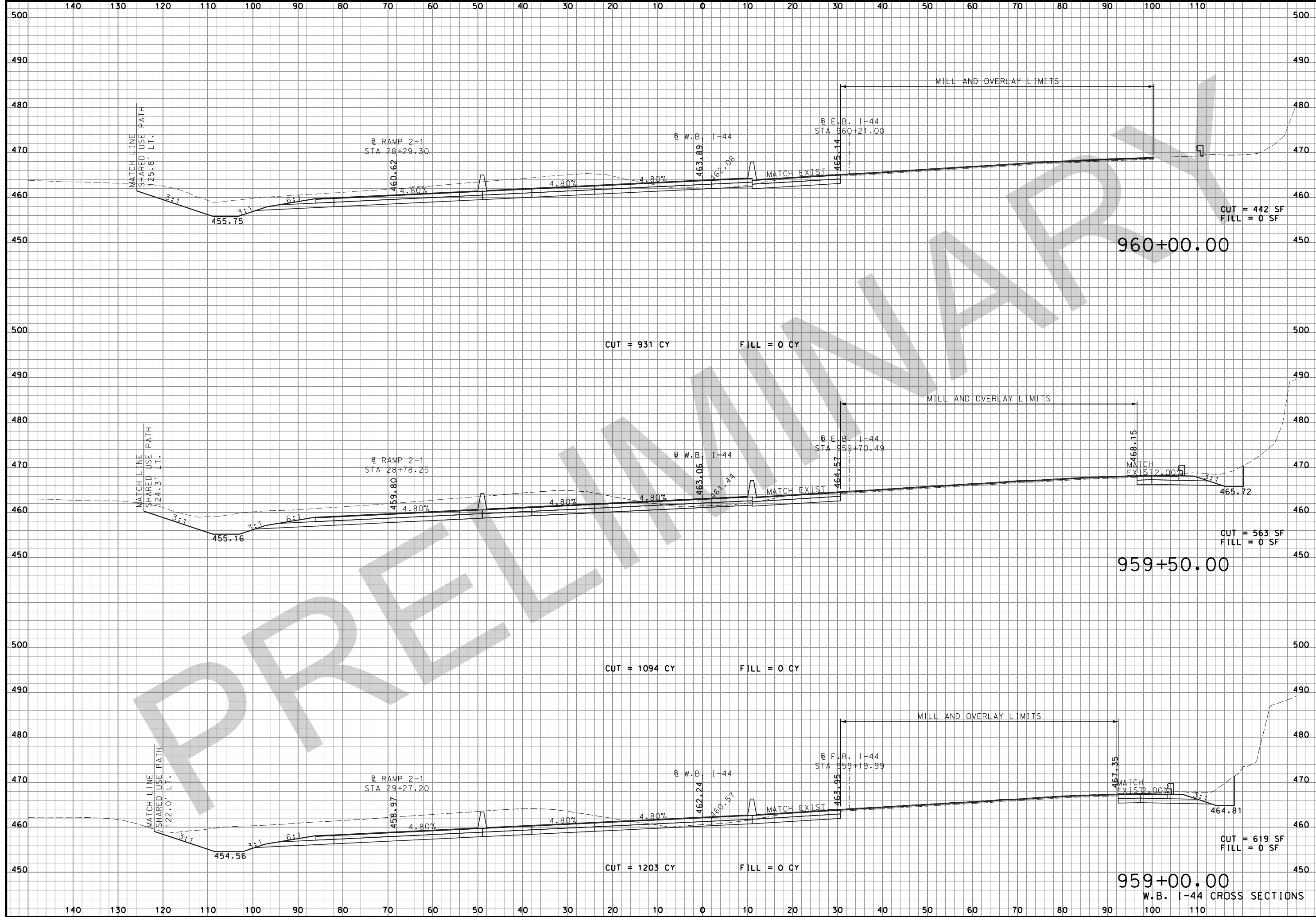

"THIS MEDIA SHOULD NOT BE CONSIDERED A CERTIFIED DOCUMENT."

DATE PREPARED 08-FEB-2018	
ROUTE I-44	STATE MO
DISTRICT SL	SHEET NO. XS16
COUNTY ST. LOUIS	
JOB NO. J613029	
CONTRACT ID.	
PROJECT NO.	
BRIDGE NO.	

DATE	DESCRIPTION

MISSOURI HIGHWAYS AND TRANSPORTATION COMMISSION

MODOT

105 WEST CAPITOL
JEFFERSON CITY, MO 65102
1-888-ASK-MODOT (1-888-275-6636)

JACOBS™

JACOBS ENGINEERING GROUP
501 NORTH BROADWAY
ST. LOUIS, MISSOURI 63102-2121
PHONE: (314) 335-4000
CERTIFICATE OF AUTHORITY #00704

IF A SEAL IS PRESENT ON THIS SHEET IT HAS BEEN ELECTRONICALLY SEALED AND DATED:

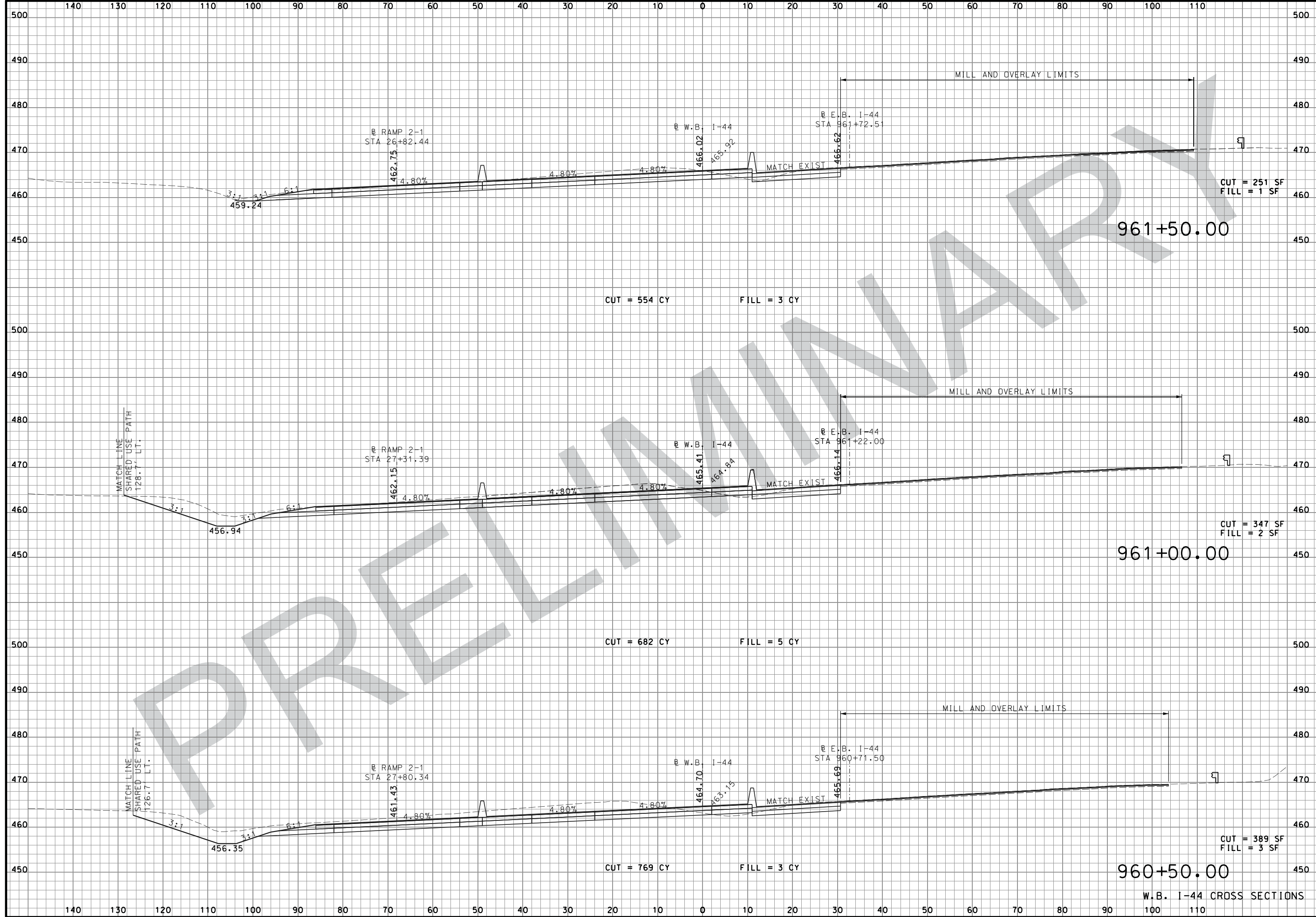

"THIS MEDIA SHOULD NOT BE CONSIDERED A CERTIFIED DOCUMENT."

DATE PREPARED 08-FEB-2018	
ROUTE I-44	STATE MO
DISTRICT SL	SHEET NO. XS17
COUNTY ST. LOUIS	
JOB NO. J613029	
CONTRACT ID.	
PROJECT NO.	
BRIDGE NO.	

DESCRIPTION	DATE

MISSOURI HIGHWAYS AND TRANSPORTATION COMMISSION



105 WEST CAPITOL
JEFFERSON CITY, MO 65102
1-888-ASK-MODOT (1-888-275-6636)

JACOBS

JACOBS ENGINEERING GROUP
501 NORTH BROADWAY
ST. LOUIS, MISSOURI 63102-2121
PHONE: (314) 335-4000
CERTIFICATE OF AUTHORITY #00704

W.B. I-44 CROSS SECTIONS

IF A SEAL IS PRESENT ON THIS SHEET IT HAS BEEN ELECTRONICALLY SEALED AND DATED:

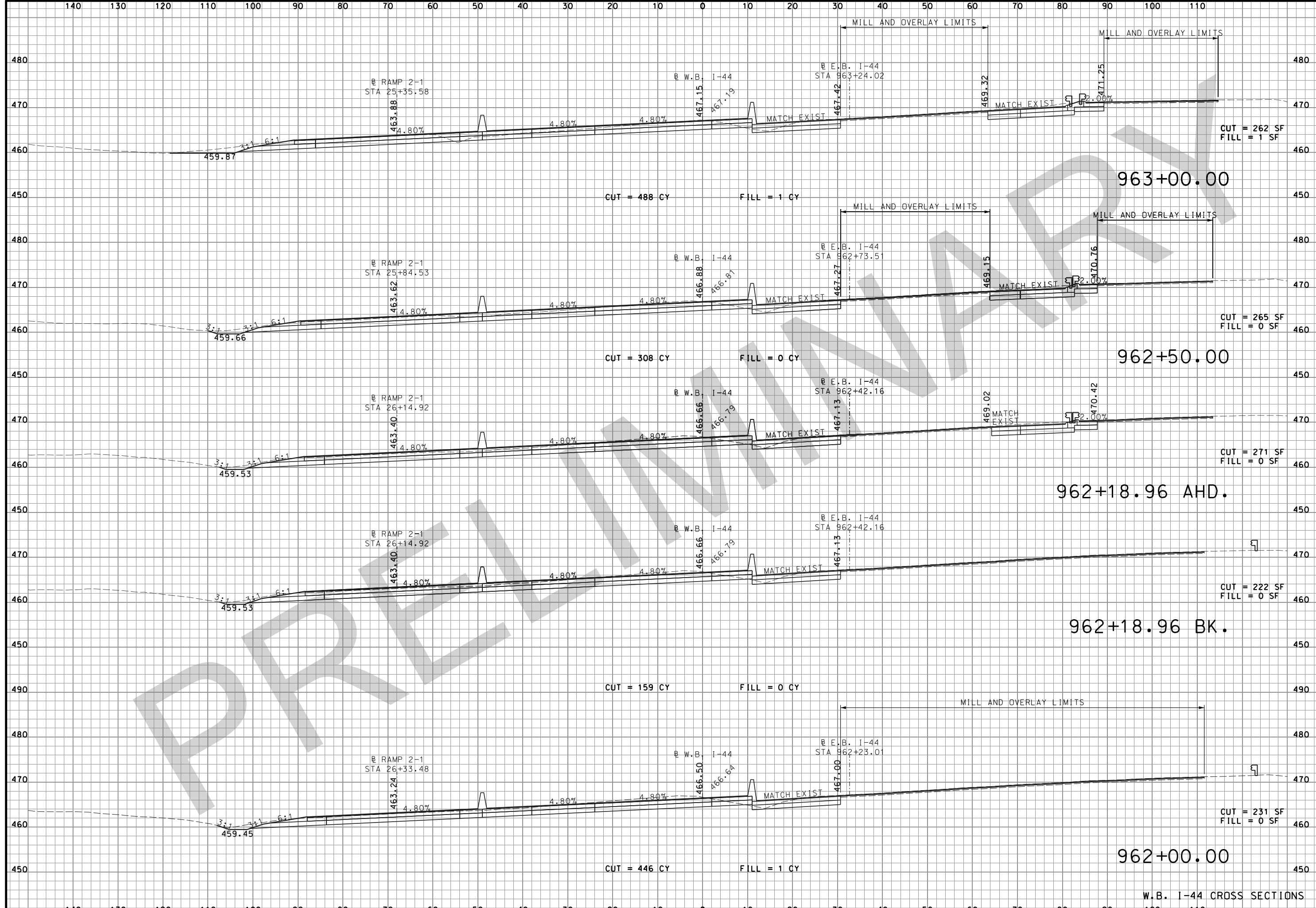

"THIS MEDIA SHOULD NOT BE CONSIDERED A CERTIFIED DOCUMENT."

DATE PREPARED 08-FEB-2018	
ROUTE I-44	STATE MO
DISTRICT SL	SHEET NO. XS18
COUNTY ST. LOUIS	
JOB NO. J613029	
CONTRACT ID.	

PROJECT NO.
BRIDGE NO.

DATE	DESCRIPTION

MISSOURI HIGHWAYS AND TRANSPORTATION COMMISSION

105 WEST CAPITOL
JEFFERSON CITY, MO 65102
1-888-ASK-MODOT (1-888-275-6636)

JACOBS

JACOBS ENGINEERING GROUP
501 NORTH BROADWAY
ST. LOUIS, MISSOURI 63102-2121
PHONE: (314) 335-4000
CERTIFICATE OF AUTHORITY #00704

IF A SEAL IS PRESENT ON THIS SHEET IT HAS BEEN ELECTRONICALLY SEALED AND DATED:

W.B. I-44 CROSS SECTIONS

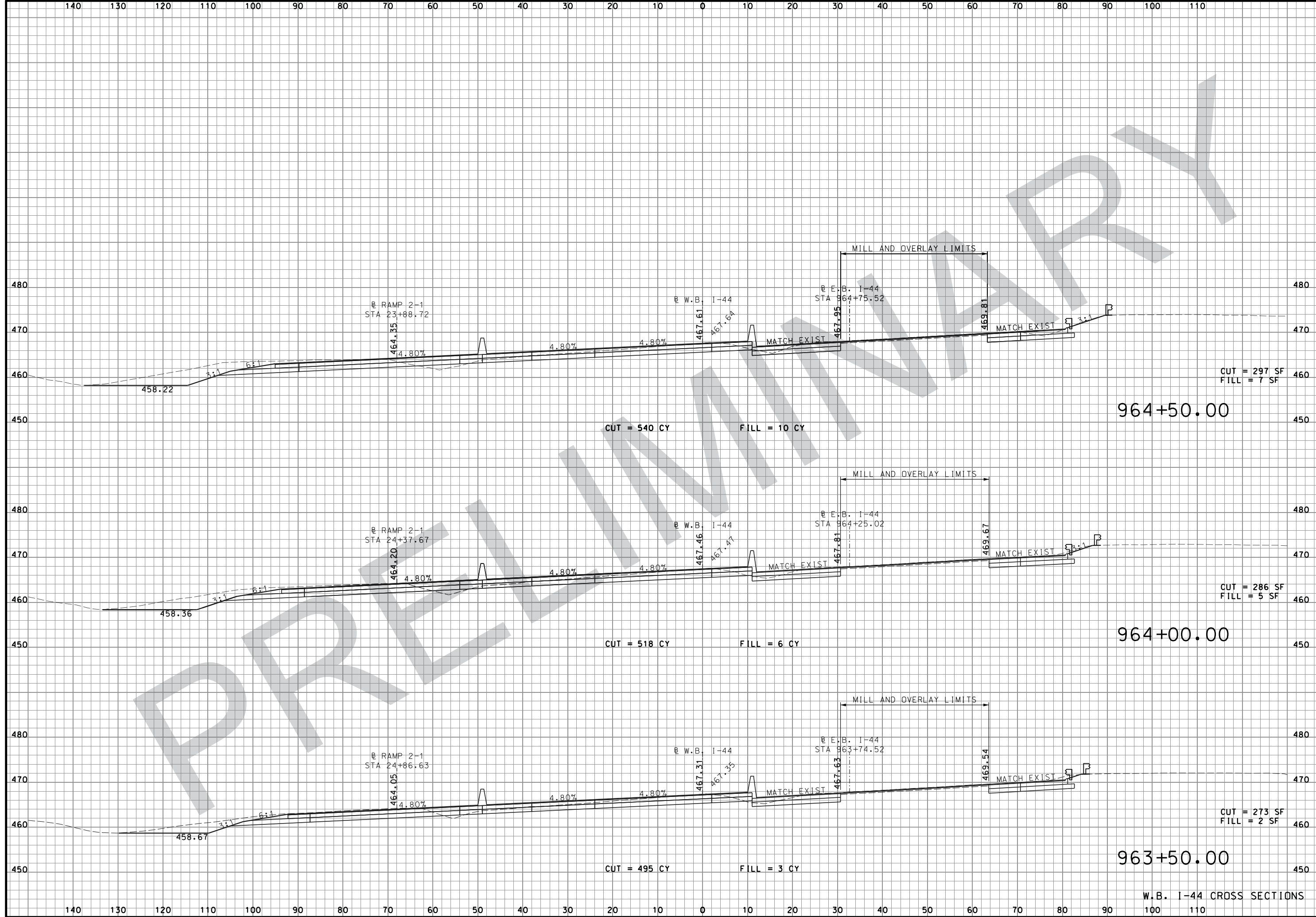

"THIS MEDIA SHOULD NOT BE CONSIDERED A CERTIFIED DOCUMENT."

DATE PREPARED 08-FEB-2018	
ROUTE I-44	STATE MO
DISTRICT SL	SHEET NO. XS19
COUNTY ST. LOUIS	
JOB NO. J613029	
CONTRACT ID.	
PROJECT NO.	
BRIDGE NO.	

DESCRIPTION	DATE

MISSOURI HIGHWAYS AND TRANSPORTATION COMMISSION

MODOT

105 WEST CAPITOL
JEFFERSON CITY, MO 65102
1-888-ASK-MODOT (1-888-275-6636)

JACOBS™

JACOBS ENGINEERING GROUP
501 NORTH BROADWAY
ST. LOUIS, MISSOURI 63102-2121
PHONE: (314) 335-4000
CERTIFICATE OF AUTHORITY #00704

W.B. I-44 CROSS SECTIONS

IF A SEAL IS PRESENT ON THIS SHEET IT HAS BEEN ELECTRONICALLY SEALED AND DATED:

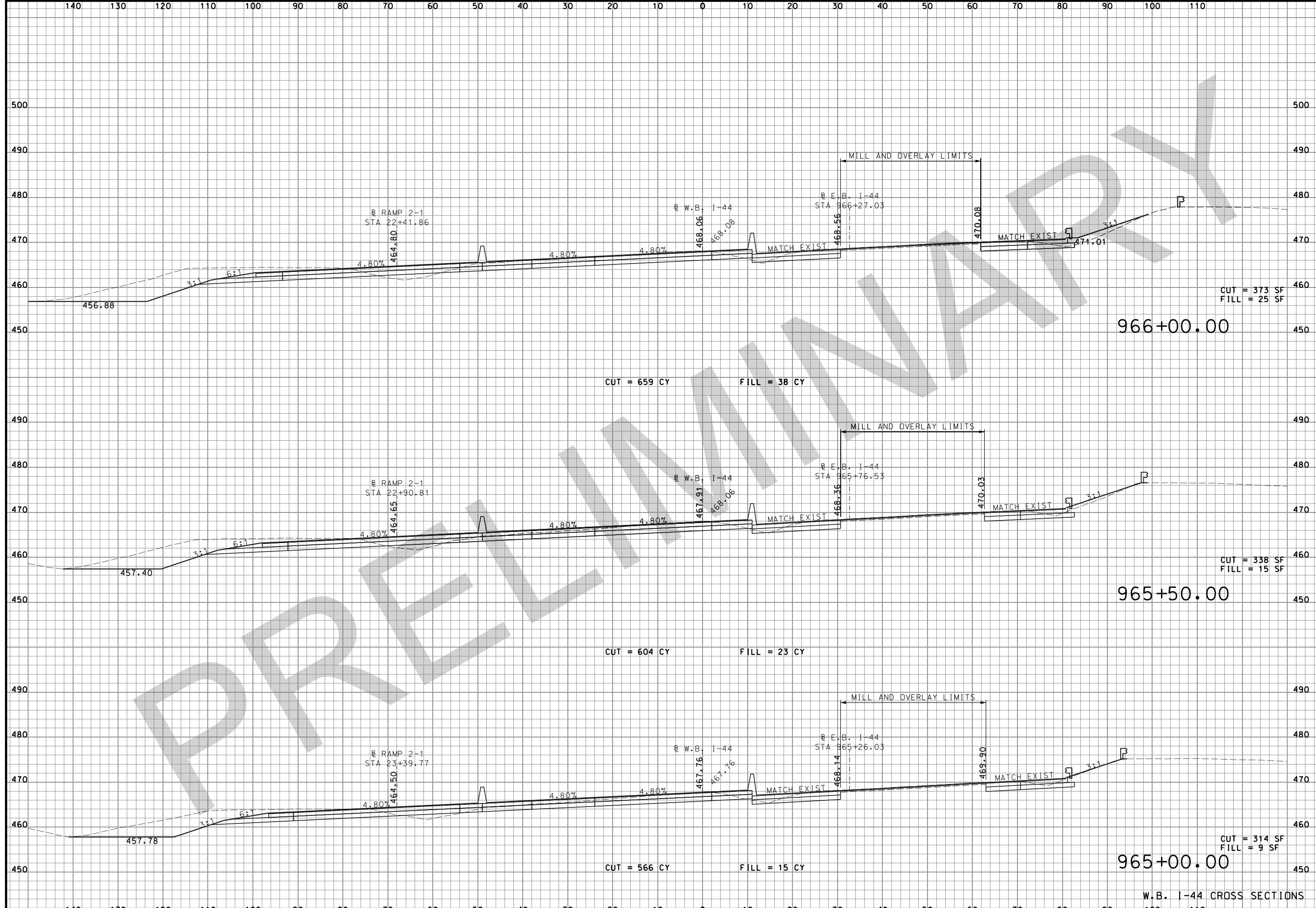



"THIS MEDIA SHOULD NOT BE CONSIDERED A CERTIFIED DOCUMENT."

DATE PREPARED 08-FEB-2018	
ROUTE I-44	STATE MO
DISTRICT SL	SHEET NO. XS20
COUNTY ST. LOUIS	
JOB NO. J613029	
CONTRACT ID.	
PROJECT NO.	
BRIDGE NO.	

DESCRIPTION	DATE

MISSOURI HIGHWAYS AND TRANSPORTATION COMMISSION

 105 WEST CAPITOL
 JEFFERSON CITY, MO 65102
 1-888-ASK-MODDOT (1-888-275-6636)

 JACOBS ENGINEERING GROUP
 501 NORTH BROADWAY
 ST. LOUIS, MISSOURI 63102-2121
 PHONE: (314) 335-4000
 CERTIFICATE OF AUTHORITY #00704

W.B. I-44 CROSS SECTIONS

IF A SEAL IS PRESENT ON THIS SHEET IT HAS BEEN ELECTRONICALLY SEALED AND DATED:

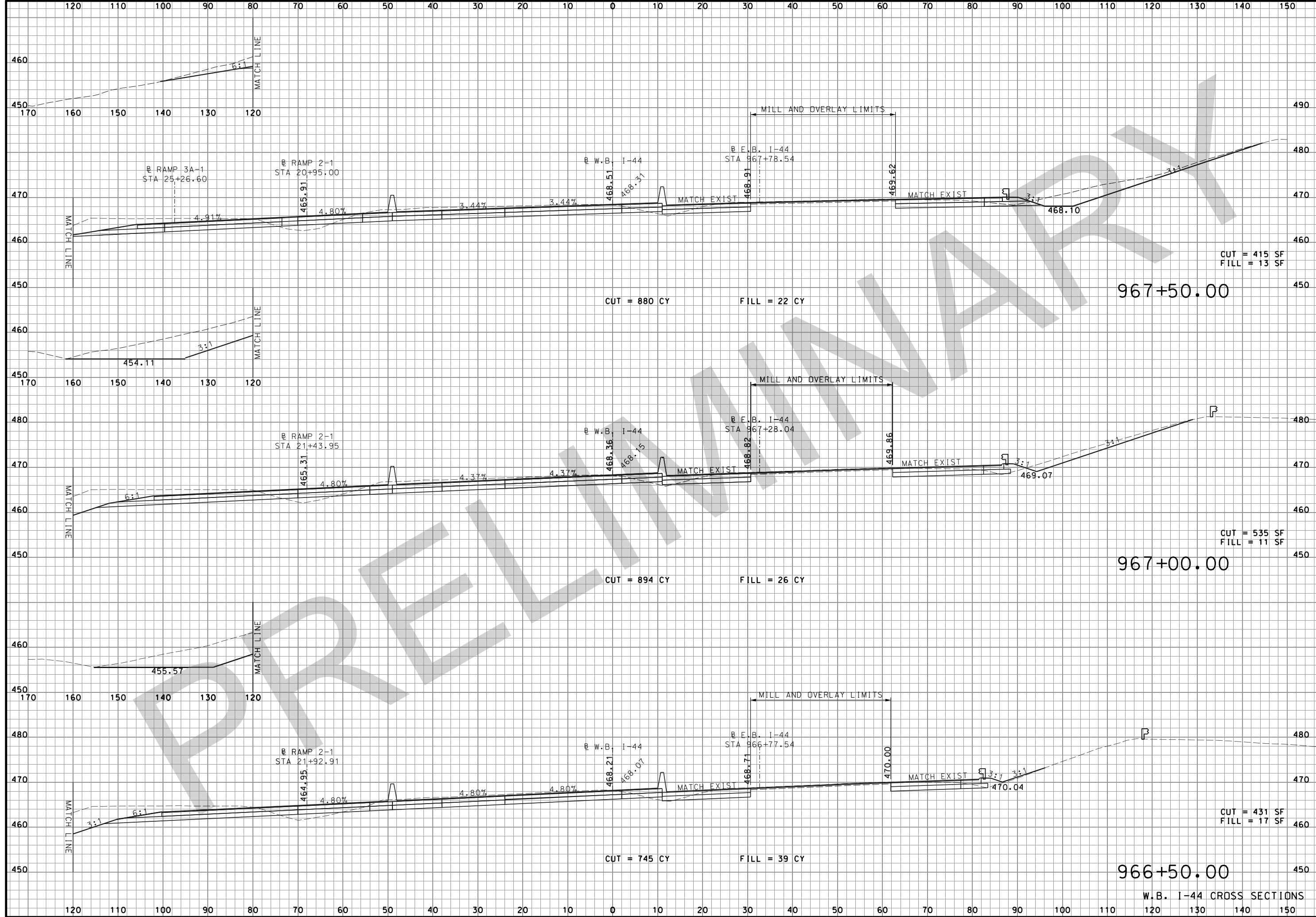

"THIS MEDIA SHOULD NOT BE CONSIDERED A CERTIFIED DOCUMENT."

DATE PREPARED 08-FEB-2018	
ROUTE I-44	STATE MO
DISTRICT SL	SHEET NO. XS21
COUNTY ST. LOUIS	
JOB NO. J613029	
CONTRACT ID.	
PROJECT NO.	
BRIDGE NO.	

DATE	DESCRIPTION

MISSOURI HIGHWAYS AND TRANSPORTATION COMMISSION

105 WEST CAPITOL
JEFFERSON CITY, MO 65102
1-888-ASK-MODOT (1-888-275-6636)

JACOBS ENGINEERING GROUP
501 NORTH BROADWAY
ST. LOUIS, MISSOURI 63102-2121
PHONE: (314) 336-4000
CERTIFICATE OF AUTHORITY #00704

W.B. I-44 CROSS SECTIONS

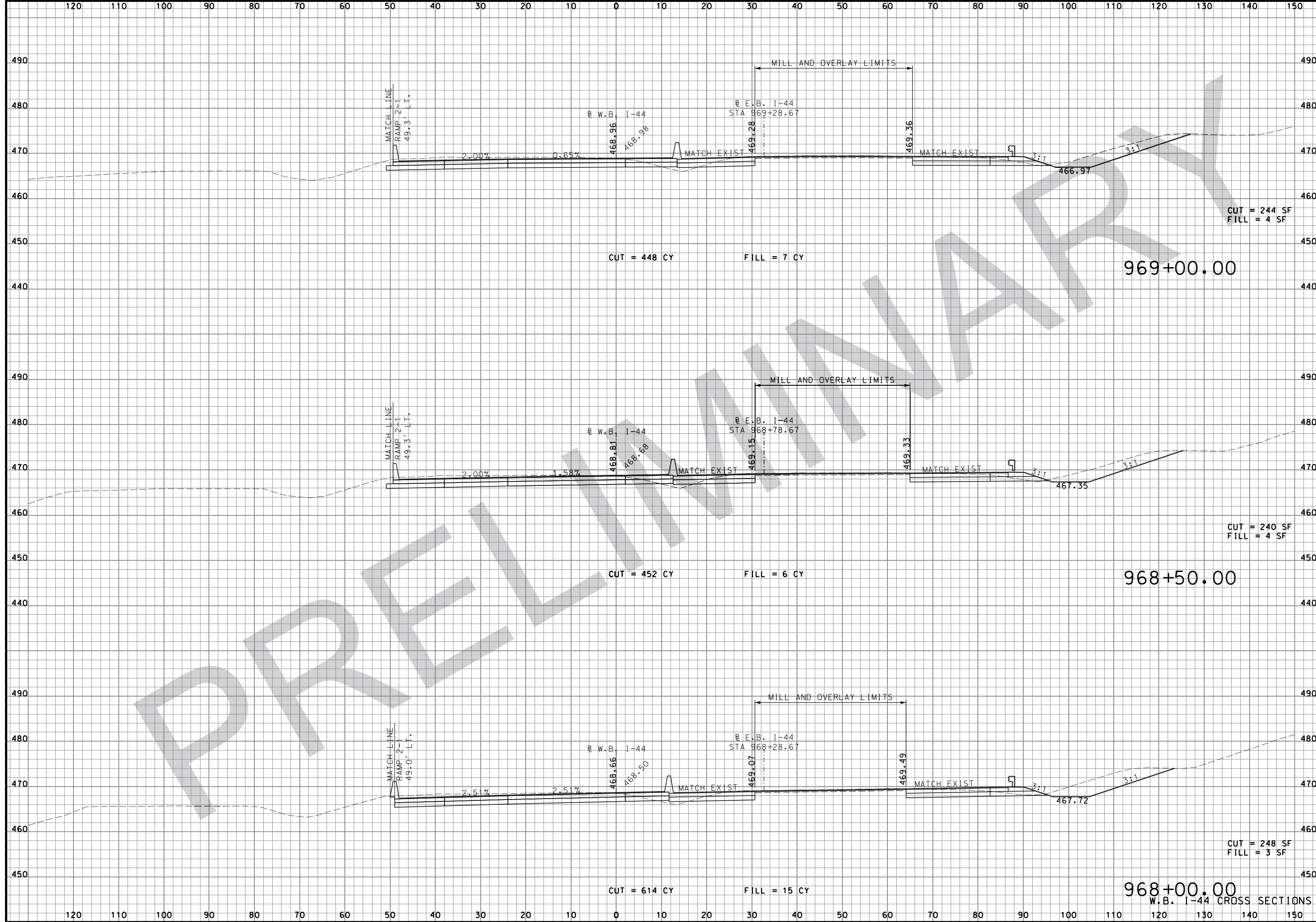

"THIS MEDIA SHOULD NOT BE CONSIDERED A CERTIFIED DOCUMENT."

DATE PREPARED
08-FEB-2018
ROUTE I-44 STATE MO
DISTRICT SL SHEET NO. XS22
COUNTY ST. LOUIS
JOB NO. J613029
CONTRACT ID.

PROJECT NO.
BRIDGE NO.

DATE	DESCRIPTION

MISSOURI HIGHWAYS AND TRANSPORTATION COMMISSION

 105 WEST CAPITOL
 JEFFERSON CITY, MO 65102
 1-888-ASK-MODOT (1-888-275-6636)

JACOBS
 JACOBS ENGINEERING GROUP
 501 NORTH BROADWAY
 ST. LOUIS, MISSOURI 63102-2121
 PHONE: (314) 335-4000
 CERTIFICATE OF AUTHORITY #00704

IF A SEAL IS PRESENT ON THIS SHEET IT HAS BEEN ELECTRONICALLY SEALED AND DATED:

W.B. I-44 CROSS SECTIONS

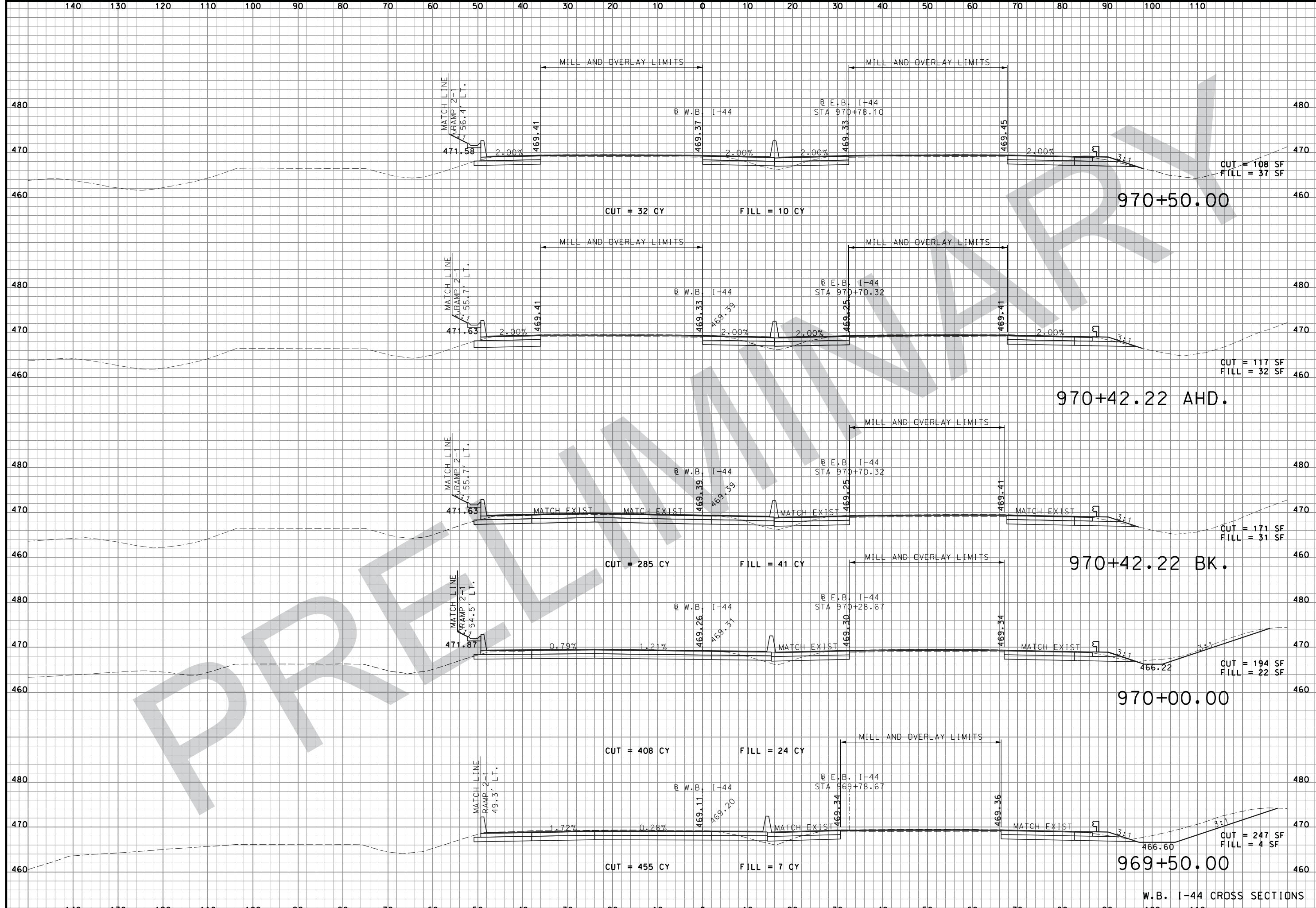

"THIS MEDIA SHOULD NOT BE CONSIDERED A CERTIFIED DOCUMENT."

DATE PREPARED 08-FEB-2018	
ROUTE I-44	STATE MO
DISTRICT SL	SHEET NO. XS23
COUNTY ST. LOUIS	
JOB NO. J613029	
CONTRACT ID.	
PROJECT NO.	
BRIDGE NO.	
DESCRIPTION	
DATE	

MISSOURI HIGHWAYS AND TRANSPORTATION COMMISSION

105 WEST CAPITOL
JEFFERSON CITY, MO 65102
1-888-ASK-MODOT (1-888-275-6636)

JACOBS ENGINEERING GROUP
501 NORTH BROADWAY
ST. LOUIS, MISSOURI 63102-2121
PHONE: (314) 336-4000
CERTIFICATE OF AUTHORITY #00704

W.B. I-44 CROSS SECTIONS

IF A SEAL IS PRESENT ON THIS SHEET IT HAS BEEN ELECTRONICALLY SEALED AND DATED:

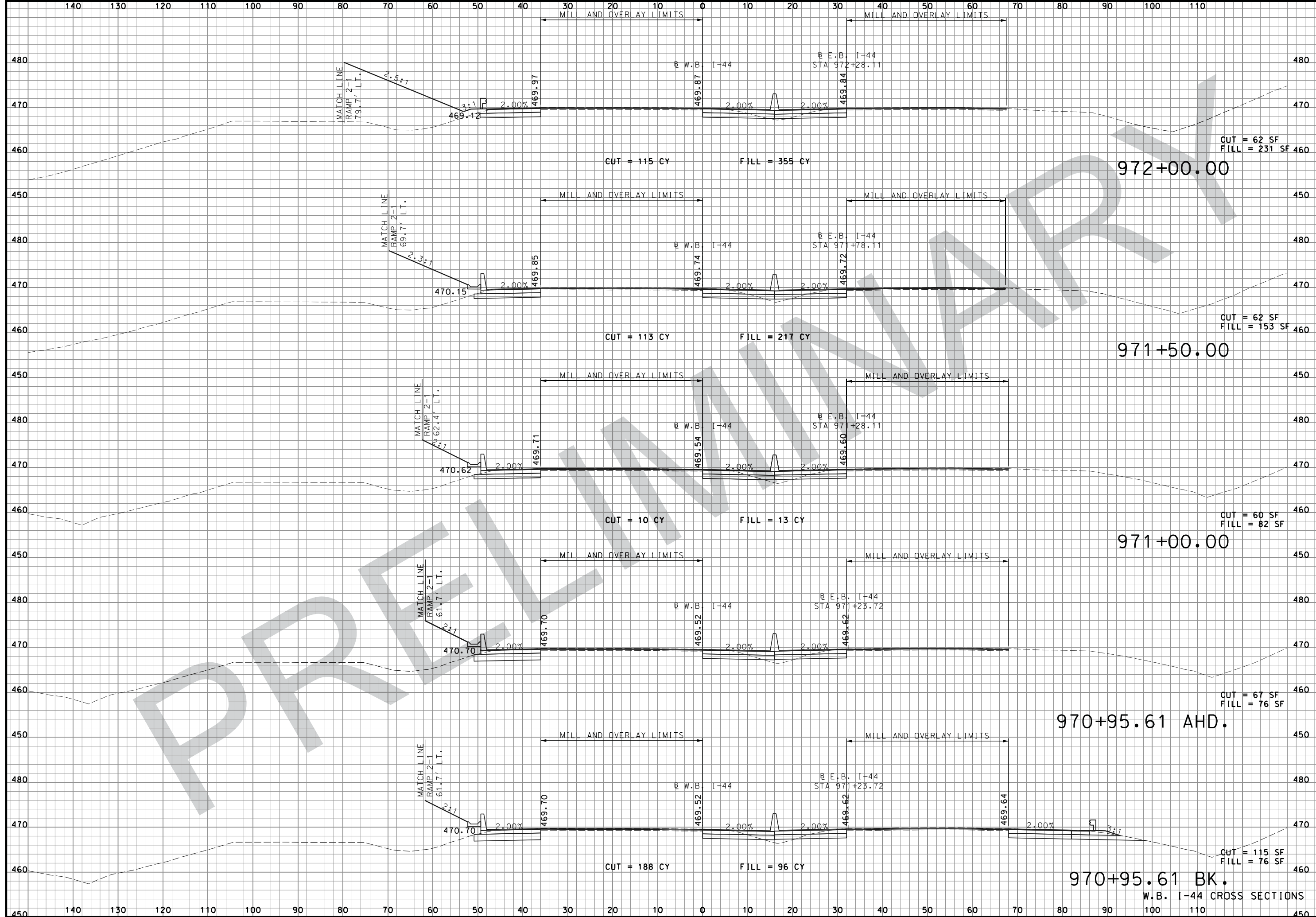

"THIS MEDIA SHOULD NOT BE CONSIDERED A CERTIFIED DOCUMENT."

DATE PREPARED: 08-FEB-2018

ROUTE: I-44 STATE: MO

DISTRICT: SL SHEET NO.: XS24

COUNTY: ST. LOUIS

JOB NO.: J613029

CONTRACT ID.:

PROJECT NO.:

BRIDGE NO.:

DESCRIPTION	DATE

MISSOURI HIGHWAYS AND TRANSPORTATION COMMISSION

MODOT

105 WEST CAPITOL
JEFFERSON CITY, MO 65102
1-888-ASK-MODOT (1-888-275-6636)

JACOBS

JACOBS ENGINEERING GROUP
501 NORTH BROADWAY
ST. LOUIS, MISSOURI 63102-2121
PHONE: (314) 335-4000
CERTIFICATE OF AUTHORITY #00704

IF A SEAL IS PRESENT ON THIS SHEET IT HAS BEEN ELECTRONICALLY SEALED AND DATED:

W.B. I-44 CROSS SECTIONS

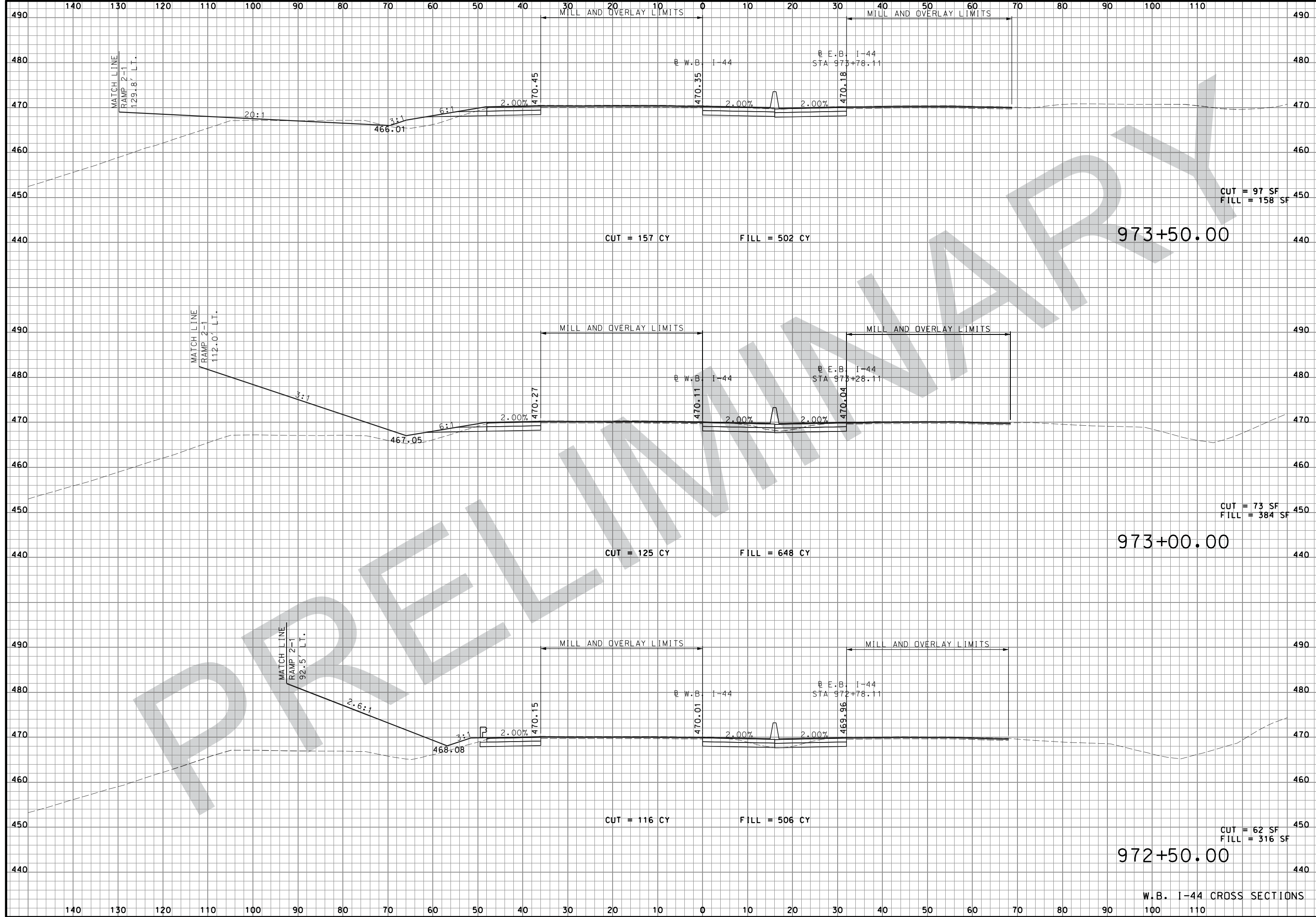

"THIS MEDIA SHOULD NOT BE CONSIDERED A CERTIFIED DOCUMENT."

DATE PREPARED
08-FEB-2018
ROUTE I-44 STATE MO
DISTRICT SL SHEET NO. XS25
COUNTY ST. LOUIS
JOB NO. J613029
CONTRACT ID.

PROJECT NO.
BRIDGE NO.

DESCRIPTION	DATE

MISSOURI HIGHWAYS AND TRANSPORTATION COMMISSION

 105 WEST CAPITOL
 JEFFERSON CITY, MO 65102
 1-888-ASK-MODOT (1-888-275-6636)

JACOBS
 JACOBS ENGINEERING GROUP
 501 NORTH BROADWAY
 ST. LOUIS, MISSOURI 63102-2121
 PHONE: (314) 335-4000
 CERTIFICATE OF AUTHORITY #00704

IF A SEAL IS PRESENT ON THIS SHEET IT HAS BEEN ELECTRONICALLY SEALED AND DATED:

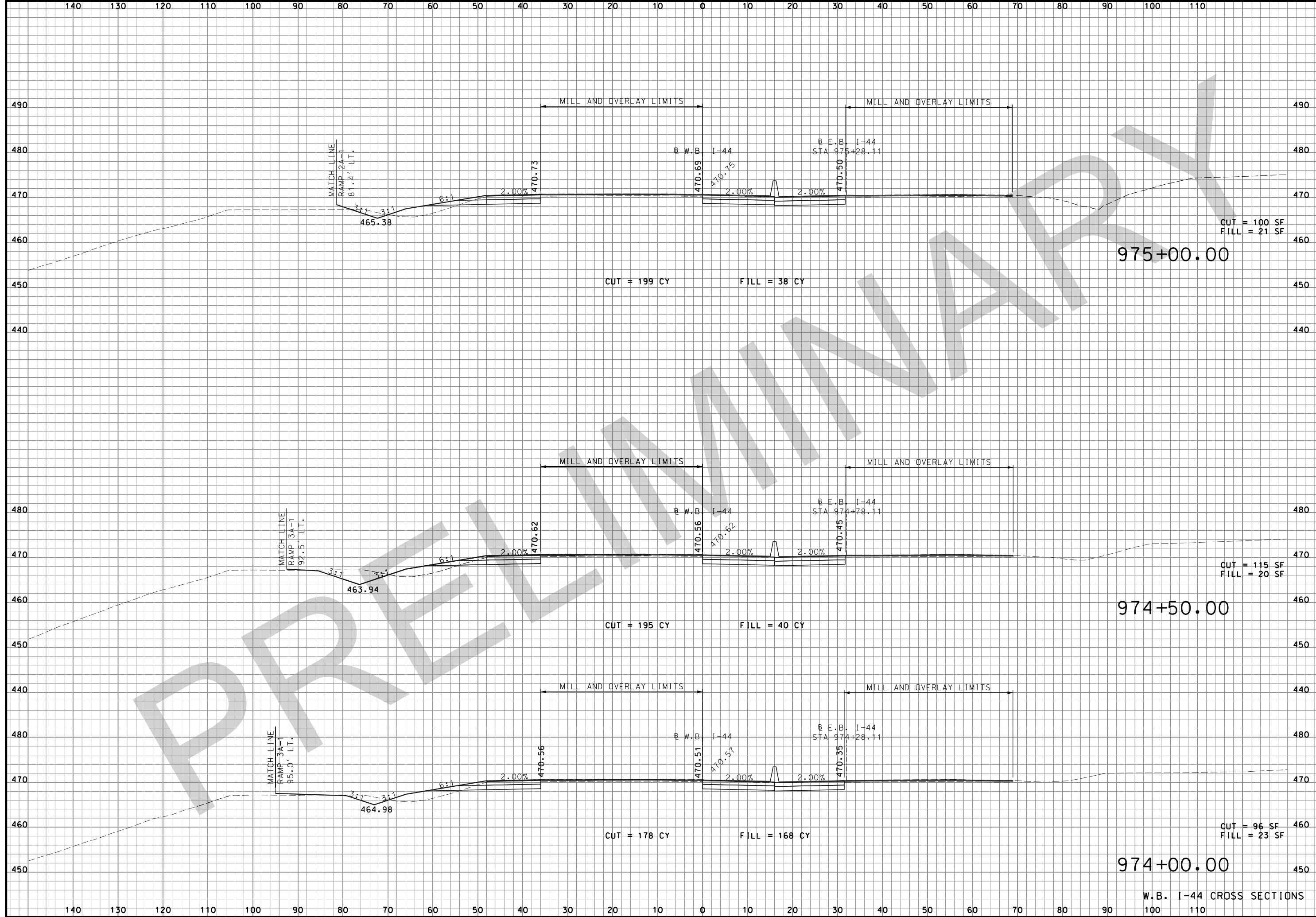
W.B. I-44 CROSS SECTIONS



"THIS MEDIA SHOULD NOT BE CONSIDERED A CERTIFIED DOCUMENT."

DATE PREPARED 08-FEB-2018	
ROUTE I-44	STATE MO
DISTRICT SL	SHEET NO. XS26
COUNTY ST. LOUIS	
JOB NO. J613029	
CONTRACT ID.	
PROJECT NO.	
BRIDGE NO.	

DATE	DESCRIPTION

MISSOURI HIGHWAYS AND TRANSPORTATION COMMISSION

MODOT

105 WEST CAPITOL
JEFFERSON CITY, MO 65102
1-888-ASK-MODOT (1-888-275-6636)

JACOBS

JACOBS ENGINEERING GROUP
501 NORTH BROADWAY
ST. LOUIS, MISSOURI 63102-2121
PHONE: (314) 335-4000
CERTIFICATE OF AUTHORITY #00704

W.B. I-44 CROSS SECTIONS

IF A SEAL IS PRESENT ON THIS SHEET IT HAS BEEN ELECTRONICALLY SEALED AND DATED:

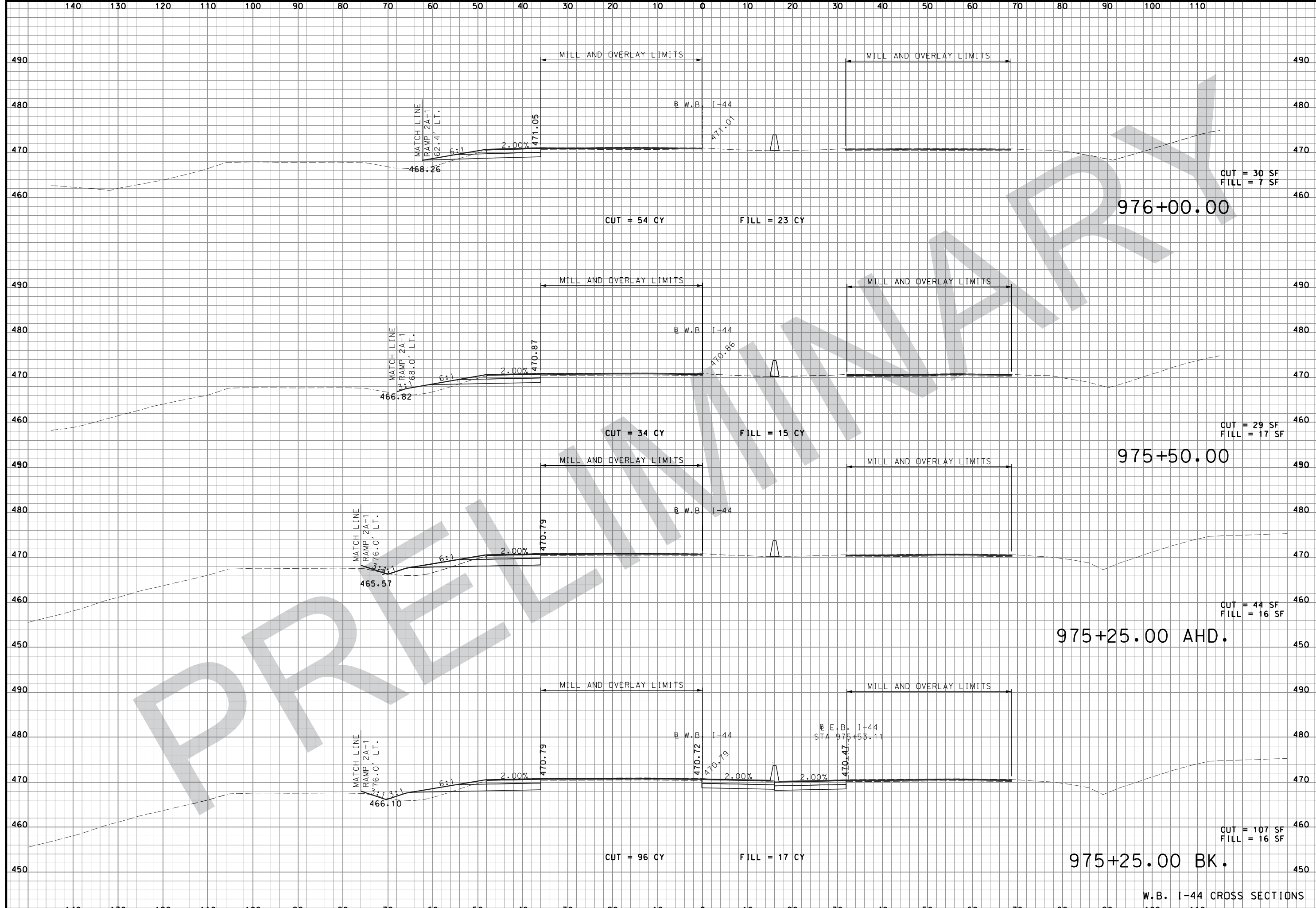

"THIS MEDIA SHOULD NOT BE CONSIDERED A CERTIFIED DOCUMENT."

DATE PREPARED 08-FEB-2018	
ROUTE I-44	STATE MO
DISTRICT SL	SHEET NO. XS27
COUNTY ST. LOUIS	
JOB NO. J613029	
CONTRACT ID.	

PROJECT NO.
BRIDGE NO.

DATE	DESCRIPTION

MISSOURI HIGHWAYS AND TRANSPORTATION COMMISSION



105 WEST CAPITOL
JEFFERSON CITY, MO 65102
1-888-ASK-MODOT (1-888-275-6636)

JACOBS

JACOBS ENGINEERING GROUP
501 NORTH BROADWAY
ST. LOUIS, MISSOURI 63102-2121
PHONE: (314) 336-4000
CERTIFICATE OF AUTHORITY #00704

IF A SEAL IS PRESENT ON THIS SHEET IT HAS BEEN ELECTRONICALLY SEALED AND DATED:

W.B. I-44 CROSS SECTIONS

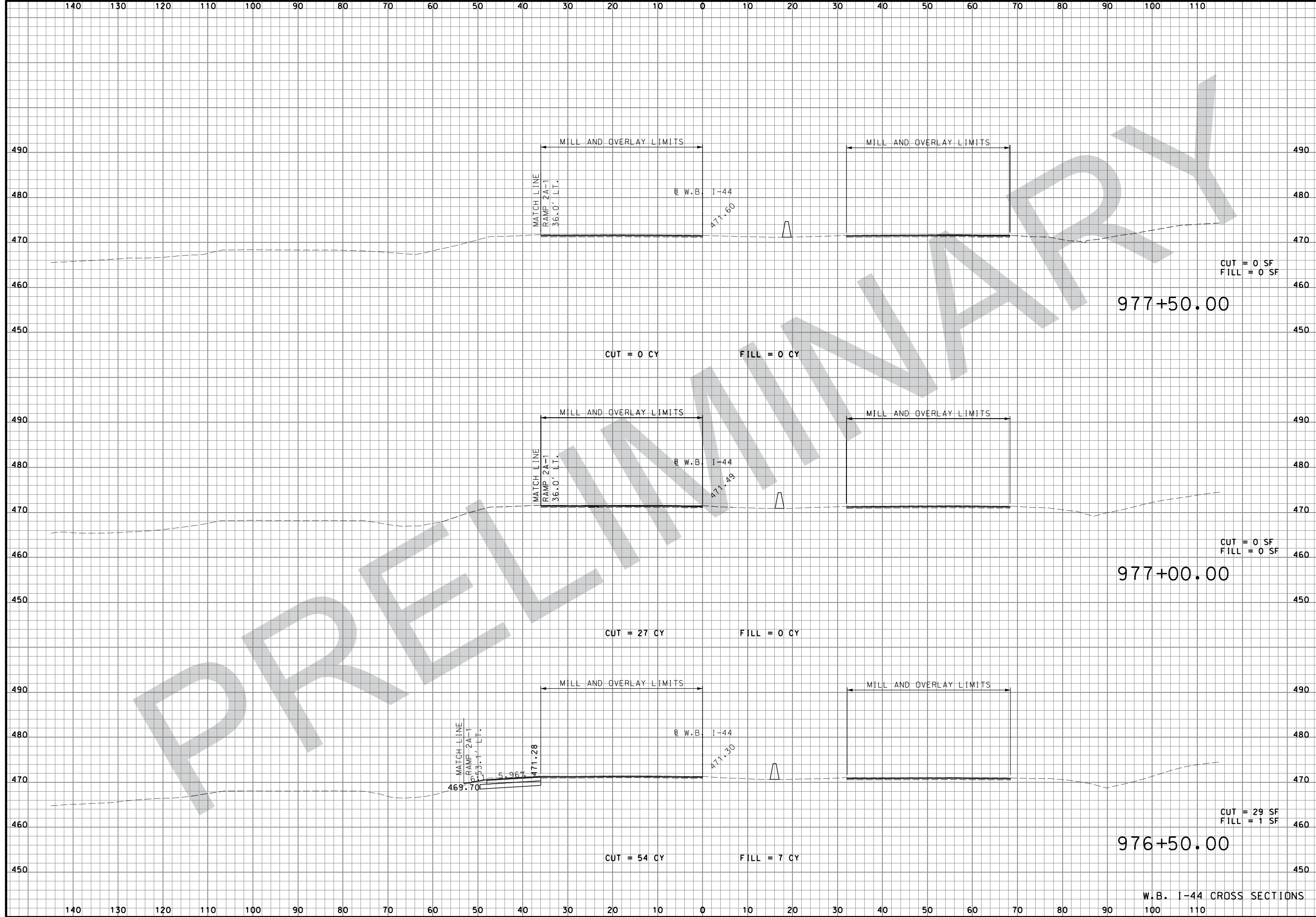

"THIS MEDIA SHOULD NOT BE CONSIDERED A CERTIFIED DOCUMENT."

DATE PREPARED 08-FEB-2018	
ROUTE I-44	STATE MO
DISTRICT SL	SHEET NO. XS28
COUNTY ST. LOUIS	
JOB NO. J613029	
CONTRACT ID.	

PROJECT NO.
BRIDGE NO.

DATE	DESCRIPTION

MISSOURI HIGHWAYS AND TRANSPORTATION COMMISSION

105 WEST CAPITOL
JEFFERSON CITY, MO 65102
1-888-ASK-MODOT (1-888-275-6636)

JACOBS

JACOBS ENGINEERING GROUP
501 NORTH BROADWAY
ST. LOUIS, MISSOURI 63102-2121
PHONE: (314) 335-4000
CERTIFICATE OF AUTHORITY #00704

IF A SEAL IS PRESENT ON THIS SHEET IT HAS BEEN ELECTRONICALLY SEALED AND DATED:

W.B. I-44 CROSS SECTIONS

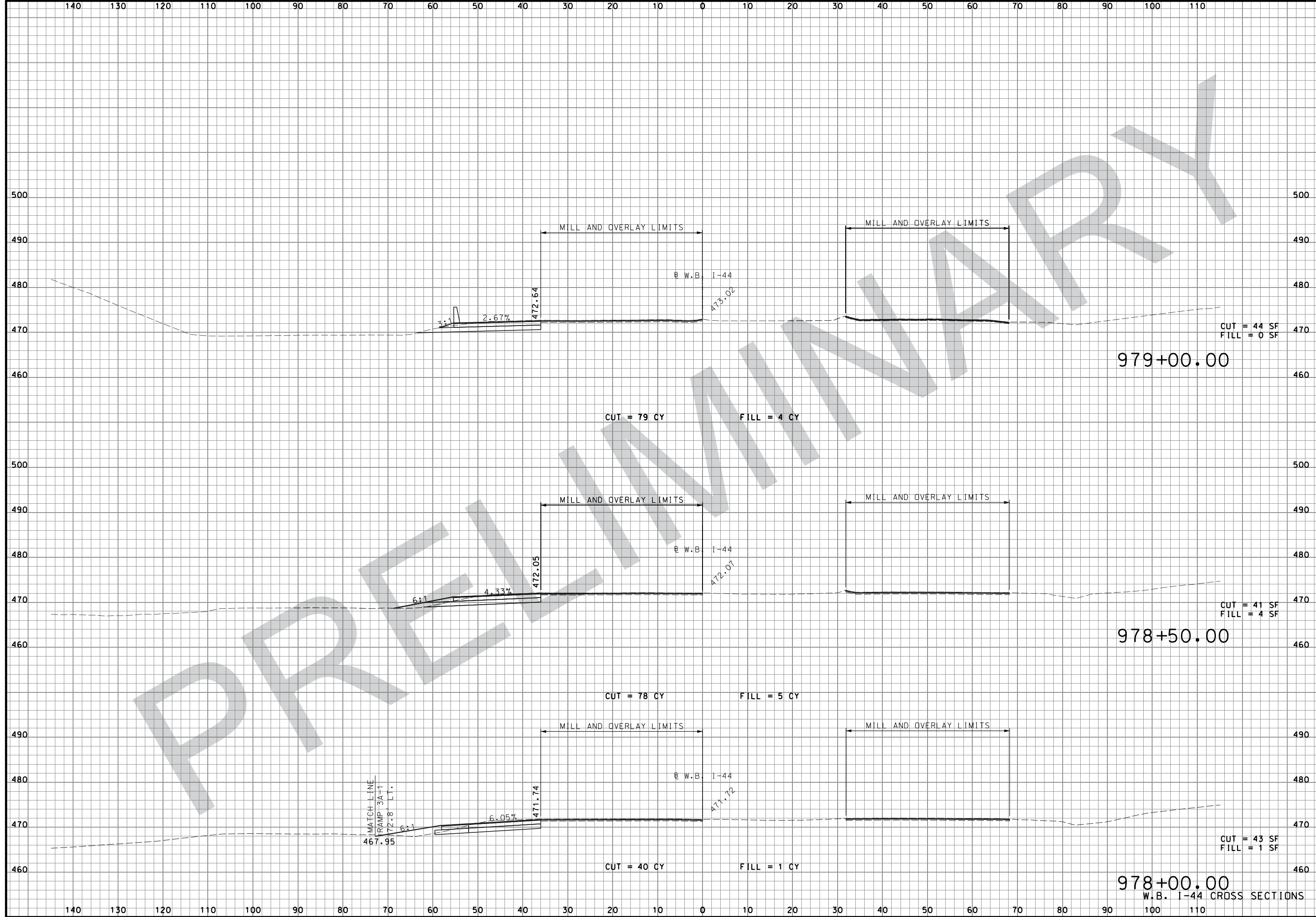

"THIS MEDIA SHOULD NOT BE CONSIDERED A CERTIFIED DOCUMENT."

DATE PREPARED
08-FEB-2018
ROUTE I-44 STATE MO
DISTRICT SL SHEET NO. XS29
COUNTY ST. LOUIS
JOB NO. J613029
CONTRACT ID.

PROJECT NO.
BRIDGE NO.

DATE	DESCRIPTION

MISSOURI HIGHWAYS AND TRANSPORTATION COMMISSION

 105 WEST CAPITOL
 JEFFERSON CITY, MO 65102
 1-888-ASK-MODOT (1-888-275-6636)

JACOBS
 JACOBS ENGINEERING GROUP
 501 NORTH BROADWAY
 ST. LOUIS, MISSOURI 63102-2121
 PHONE: (314) 335-4000
 CERTIFICATE OF AUTHORITY #00704

IF A SEAL IS PRESENT ON THIS SHEET IT HAS BEEN ELECTRONICALLY SEALED AND DATED:

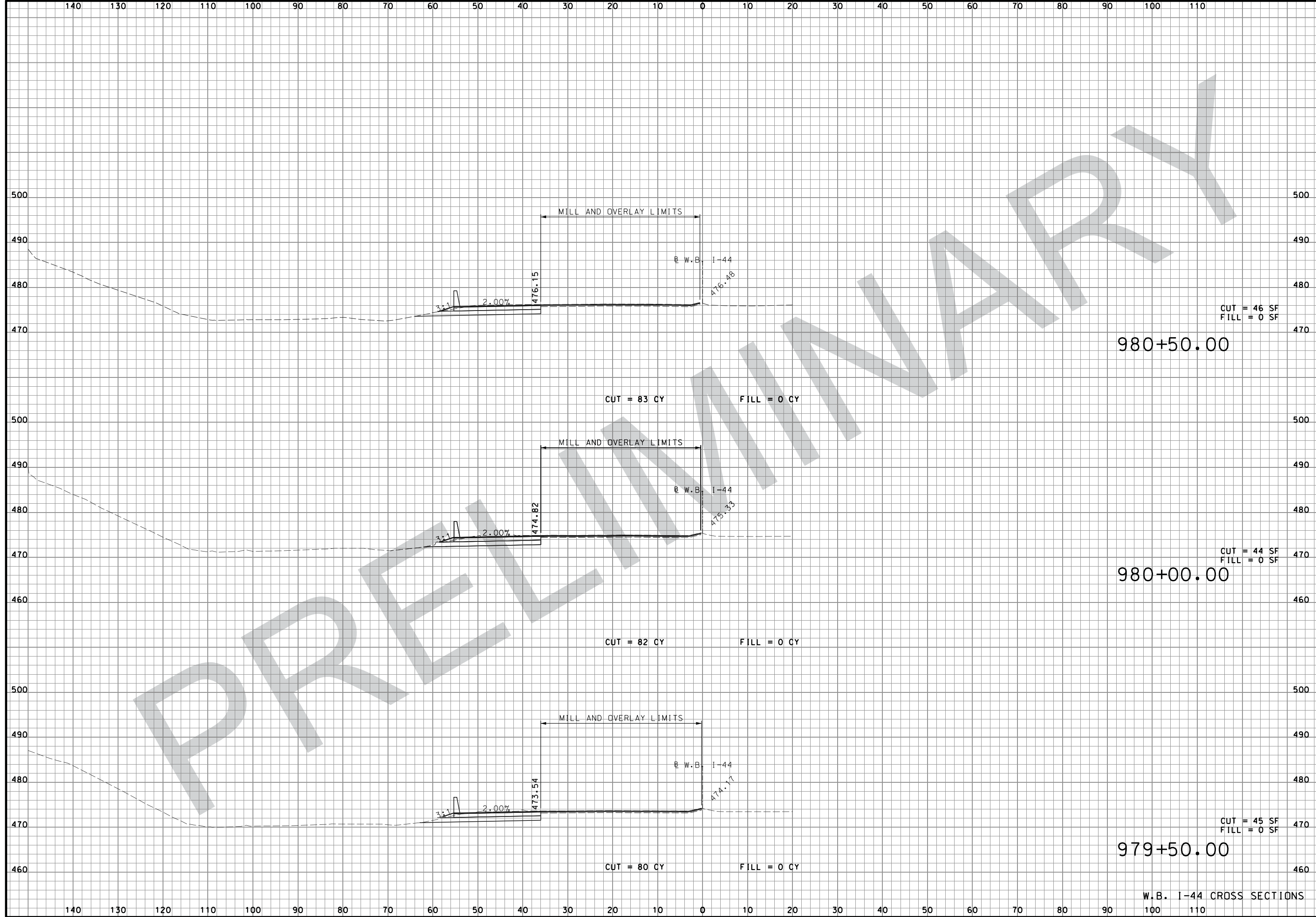

"THIS MEDIA SHOULD NOT BE CONSIDERED A CERTIFIED DOCUMENT."

DATE PREPARED
08-FEB-2018

ROUTE	STATE
I-44	MO
DISTRICT	SHEET NO.
SL	XS30

COUNTY
ST. LOUIS

JOB NO.
J613029

CONTRACT ID.

PROJECT NO.

BRIDGE NO.

DESCRIPTION	DATE

MISSOURI HIGHWAYS AND TRANSPORTATION COMMISSION

105 WEST CAPITOL
JEFFERSON CITY, MO 65102
1-888-ASK-MODOT (1-888-275-6636)

JACOBS

JACOBS ENGINEERING GROUP
501 NORTH BROADWAY
ST. LOUIS, MISSOURI 63102-2121
PHONE: (314) 335-4000
CERTIFICATE OF AUTHORITY #00704

IF A SEAL IS PRESENT ON THIS SHEET IT HAS BEEN ELECTRONICALLY SEALED AND DATED:

W.B. I-44 CROSS SECTIONS

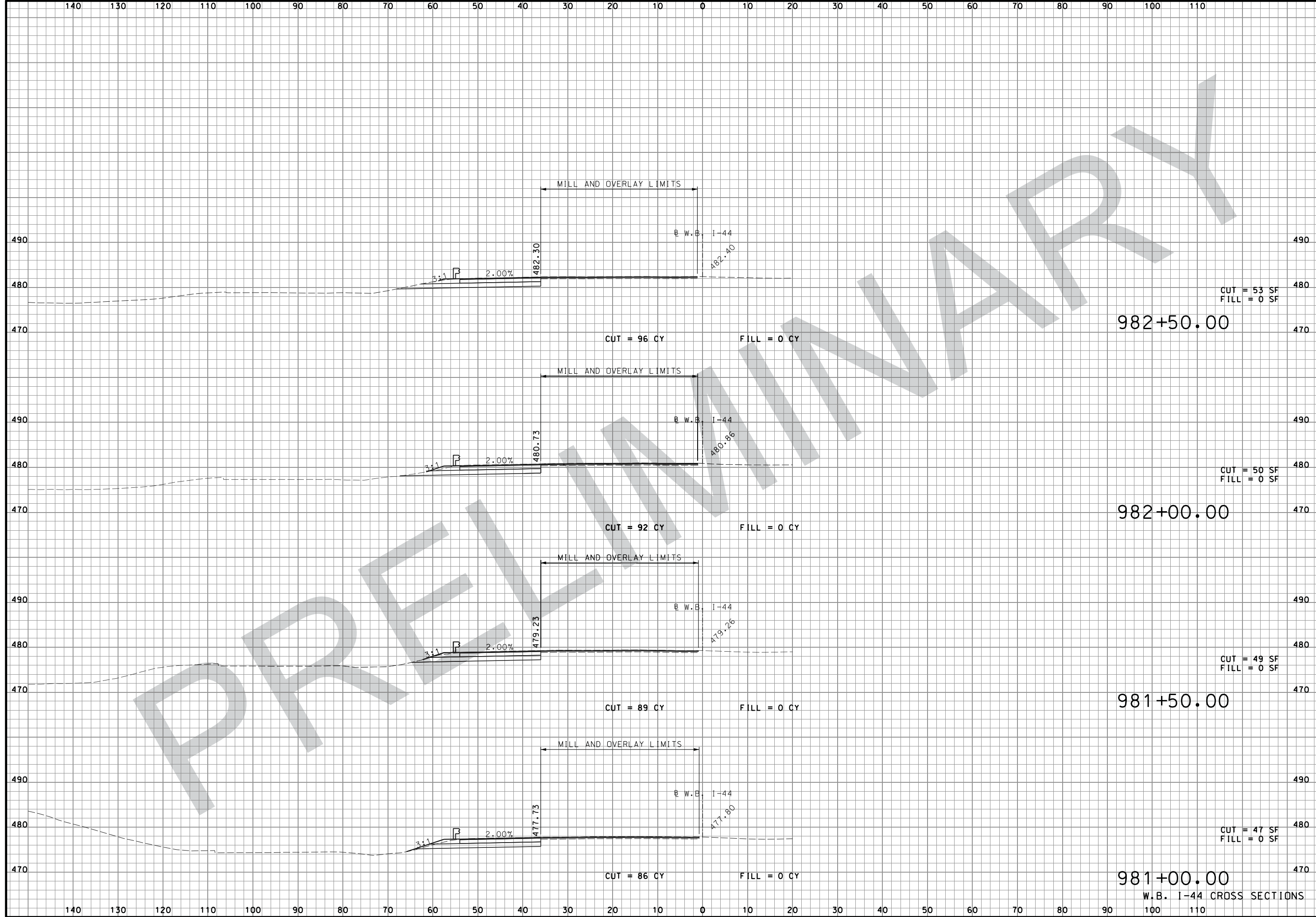

"THIS MEDIA SHOULD NOT BE CONSIDERED A CERTIFIED DOCUMENT."

DATE PREPARED
08-FEB-2018
ROUTE I-44 STATE MO
DISTRICT SL SHEET NO. XS31
COUNTY ST. LOUIS
JOB NO. J613029
CONTRACT ID.

PROJECT NO.
BRIDGE NO.

DATE	DESCRIPTION

MISSOURI HIGHWAYS AND TRANSPORTATION COMMISSION

 105 WEST CAPITOL
 JEFFERSON CITY, MO 65102
 1-888-ASK-MODOT (1-888-275-6636)

JACOBS
 JACOBS ENGINEERING GROUP
 501 NORTH BROADWAY
 ST. LOUIS, MISSOURI 63102-2121
 PHONE: (314) 335-4000
 CERTIFICATE OF AUTHORITY #00704

IF A SEAL IS PRESENT ON THIS SHEET IT HAS BEEN ELECTRONICALLY SEALED AND DATED:

W.B. I-44 CROSS SECTIONS

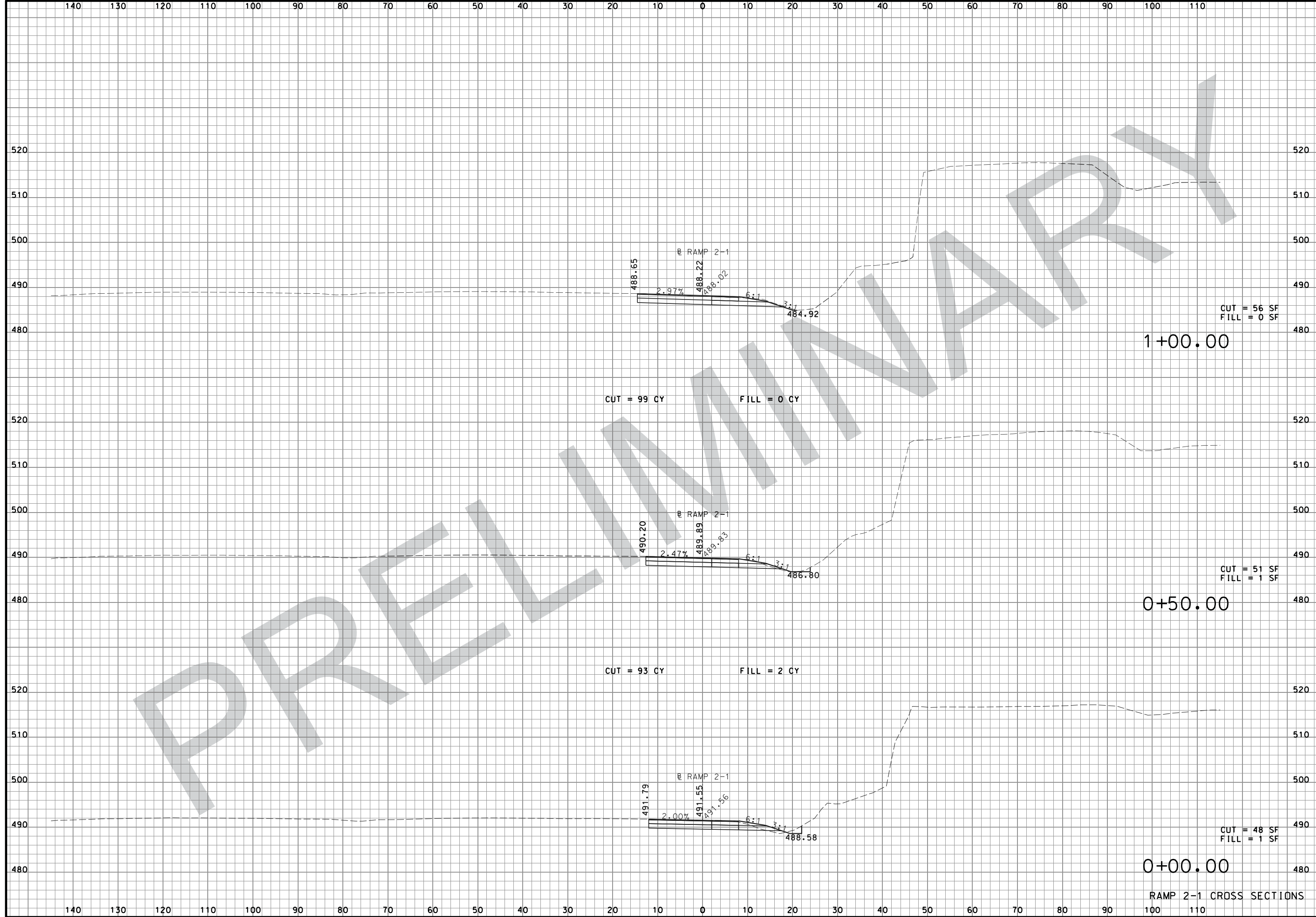

"THIS MEDIA SHOULD NOT BE CONSIDERED A CERTIFIED DOCUMENT."

DATE PREPARED
08-FEB-2018

ROUTE STATE
I-44 MO

DISTRICT SHEET NO.
SL XS32

COUNTY
ST. LOUIS

JOB NO.
J613029

CONTRACT ID.

PROJECT NO.

BRIDGE NO.

DESCRIPTION	DATE

MISSOURI HIGHWAYS AND TRANSPORTATION COMMISSION



IF A SEAL IS PRESENT ON THIS SHEET IT HAS BEEN ELECTRONICALLY SEALED AND DATED:

CUT = 56 SF
FILL = 0 SF

1+00.00

CUT = 99 CY
FILL = 0 CY

CUT = 51 SF
FILL = 1 SF

0+50.00

CUT = 93 CY
FILL = 2 CY

CUT = 48 SF
FILL = 1 SF

0+00.00

RAMP 2-1 CROSS SECTIONS

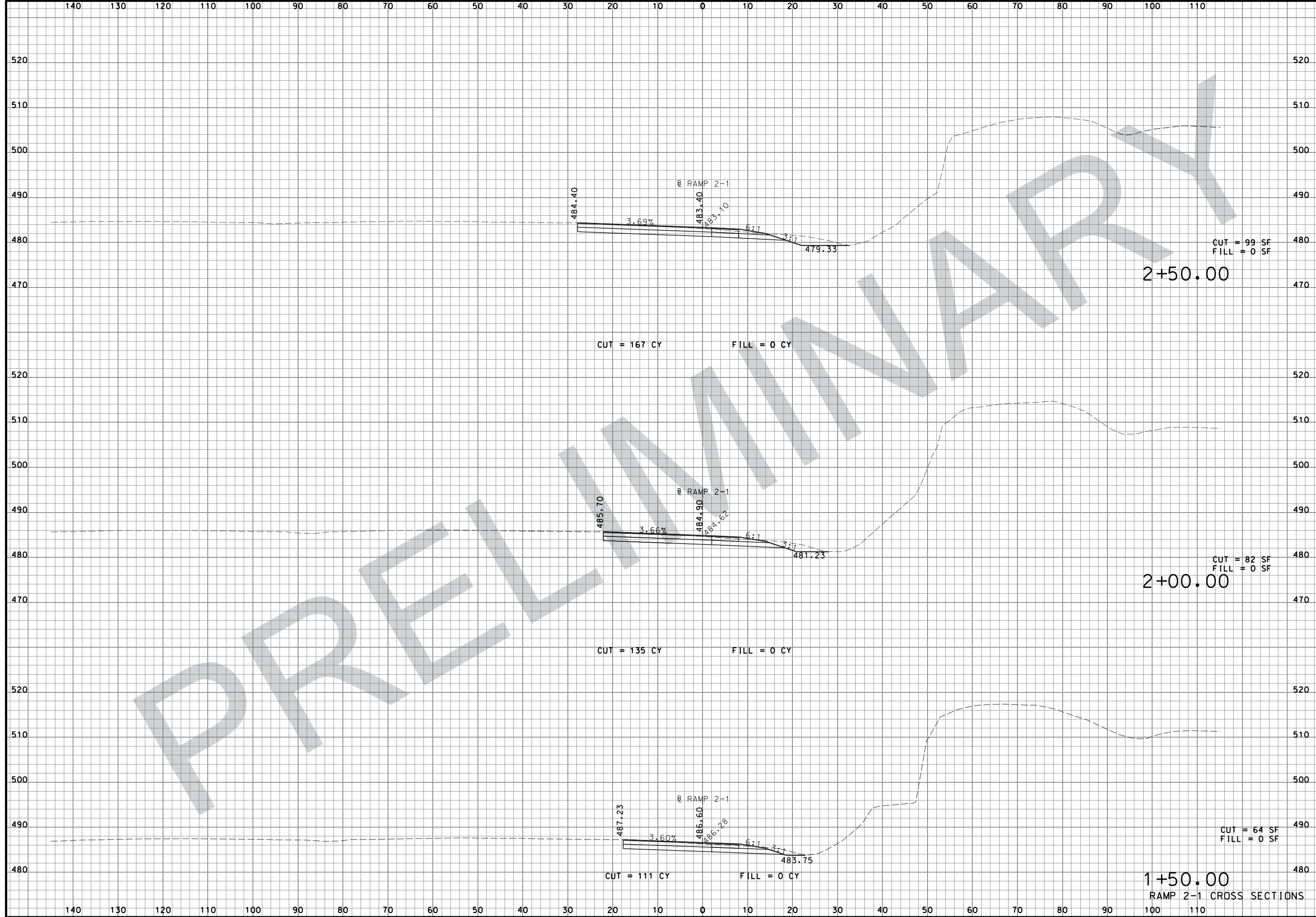

"THIS MEDIA SHOULD NOT BE CONSIDERED A CERTIFIED DOCUMENT."

DATE PREPARED 08-FEB-2018	
ROUTE I-44	STATE MO
DISTRICT SL	SHEET NO. XS33
COUNTY ST. LOUIS	
JOB NO. J613029	
CONTRACT ID.	
PROJECT NO.	
BRIDGE NO.	

DATE	DESCRIPTION

MISSOURI HIGHWAYS AND TRANSPORTATION COMMISSION



105 WEST CAPITOL
 JEFFERSON CITY, MO 65102
 1-888-ASK-MODOT (1-888-275-6636)

JACOBS
 JACOBS ENGINEERING GROUP
 501 NORTH BROADWAY
 ST. LOUIS, MISSOURI 63102-2121
 PHONE: (314) 335-4000
 CERTIFICATE OF AUTHORITY #00704

RAMP 2-1 CROSS SECTIONS

IF A SEAL IS PRESENT ON THIS SHEET IT HAS BEEN ELECTRONICALLY SEALED AND DATED:

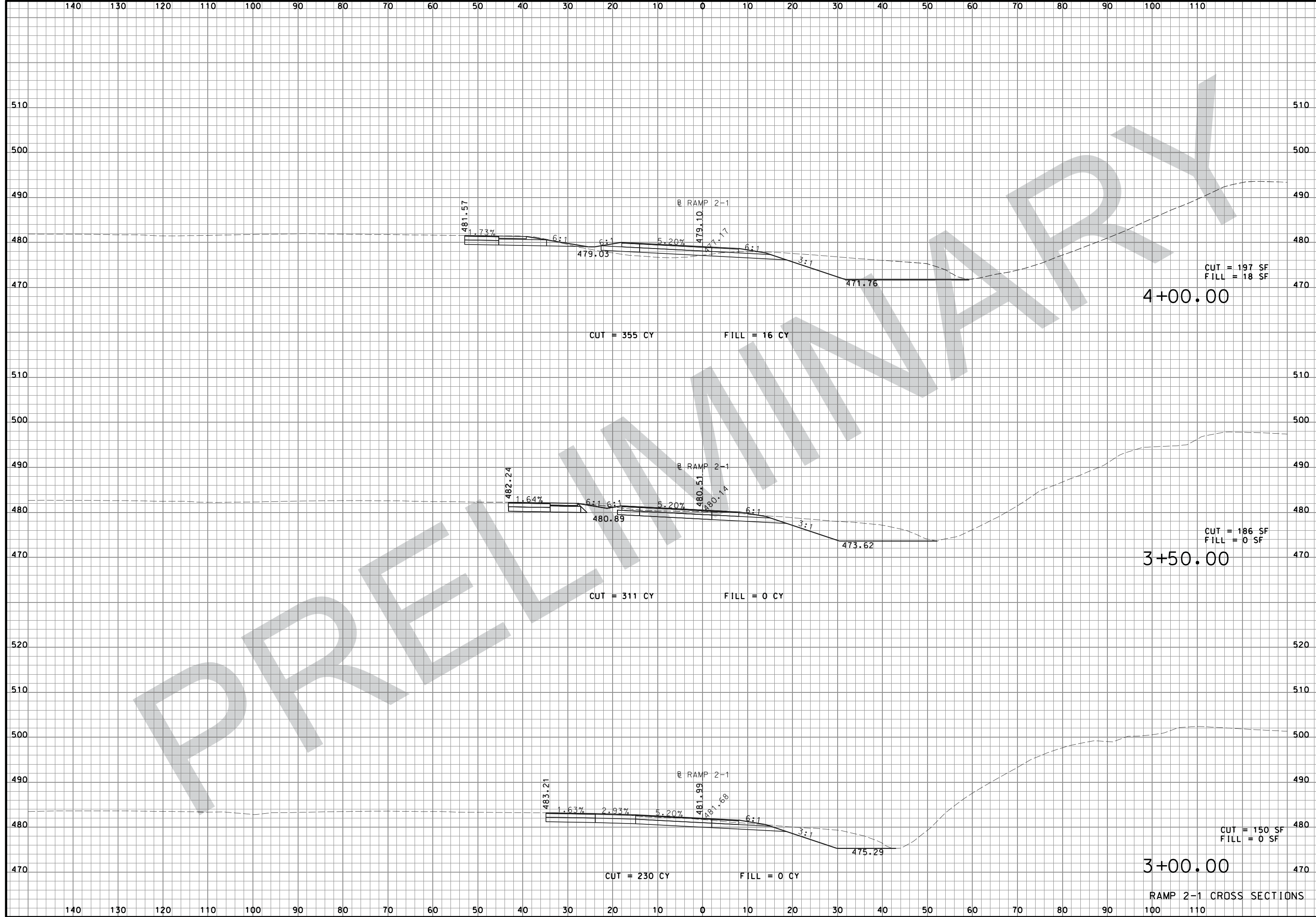

"THIS MEDIA SHOULD NOT BE CONSIDERED A CERTIFIED DOCUMENT."

DATE PREPARED 08-FEB-2018	
ROUTE I-44	STATE MO
DISTRICT SL	SHEET NO. XS34
COUNTY ST. LOUIS	
JOB NO. J613029	
CONTRACT ID.	
PROJECT NO.	
BRIDGE NO.	

DESCRIPTION	DATE

MISSOURI HIGHWAYS AND TRANSPORTATION COMMISSION

105 WEST CAPITOL
JEFFERSON CITY, MO 65102
1-888-ASK-MODOT (1-888-275-6636)

JACOBS
JACOBS ENGINEERING GROUP
501 NORTH BROADWAY
ST. LOUIS, MISSOURI 63102-2121
PHONE: (314) 335-4000
CERTIFICATE OF AUTHORITY #00704

RAMP 2-1 CROSS SECTIONS

IF A SEAL IS PRESENT ON THIS SHEET IT HAS BEEN ELECTRONICALLY SEALED AND DATED:

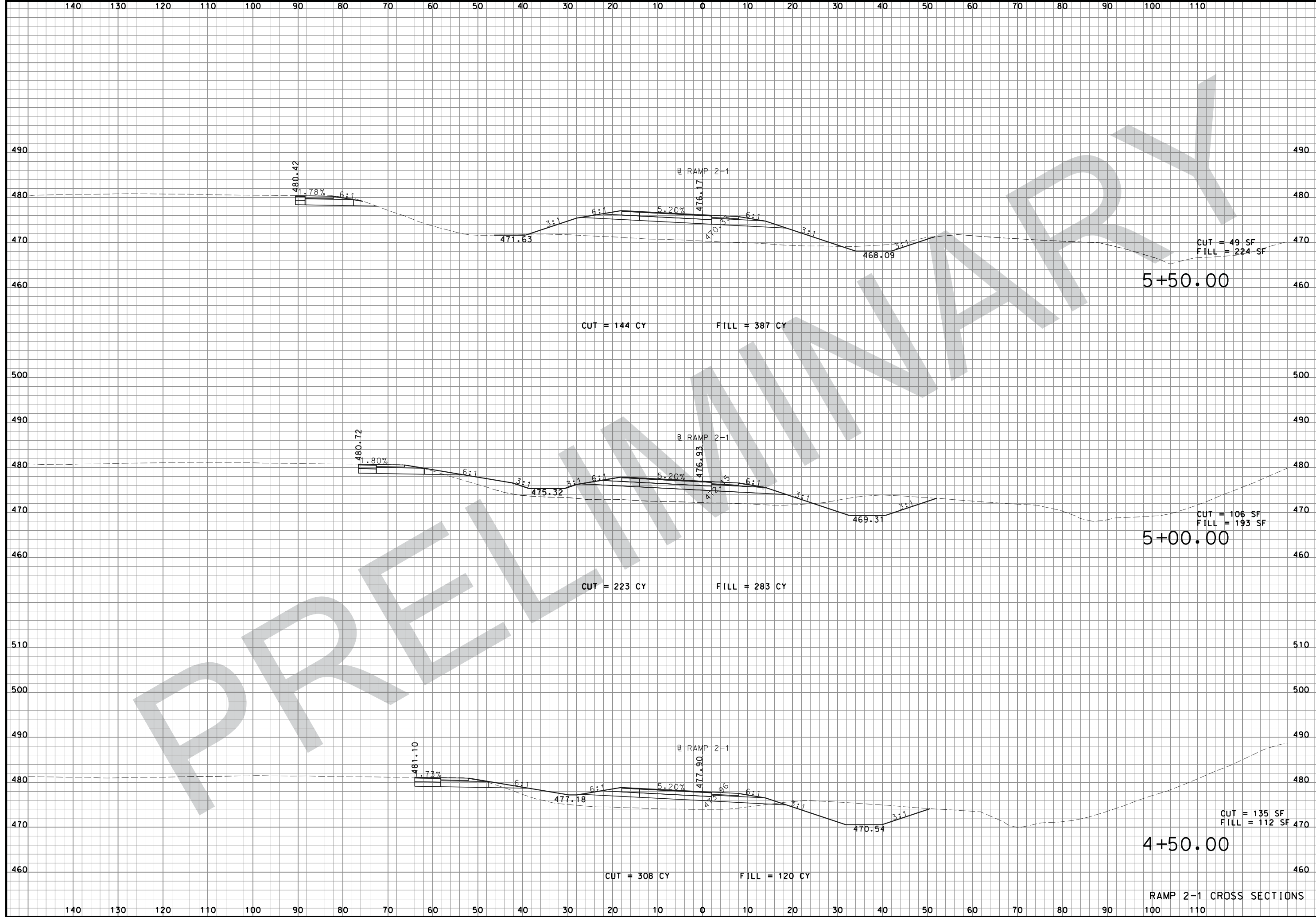

"THIS MEDIA SHOULD NOT BE CONSIDERED A CERTIFIED DOCUMENT."

DATE PREPARED
08-FEB-2018

ROUTE	STATE
I-44	MO
DISTRICT	SHEET NO.
SL	XS35

COUNTY
ST. LOUIS

JOB NO.
J613029

CONTRACT ID.

PROJECT NO.

BRIDGE NO.

DATE	DESCRIPTION

MISSOURI HIGHWAYS AND TRANSPORTATION COMMISSION



105 WEST CAPITOL
JEFFERSON CITY, MO 65102
1-888-ASK-MODOT (1-888-275-6636)

JACOBS

JACOBS ENGINEERING GROUP
501 NORTH BROADWAY
ST. LOUIS, MISSOURI 63102-2121
PHONE: (314) 335-4000
CERTIFICATE OF AUTHORITY #00704

IF A SEAL IS PRESENT ON THIS SHEET IT HAS BEEN ELECTRONICALLY SEALED AND DATED:

RAMP 2-1 CROSS SECTIONS

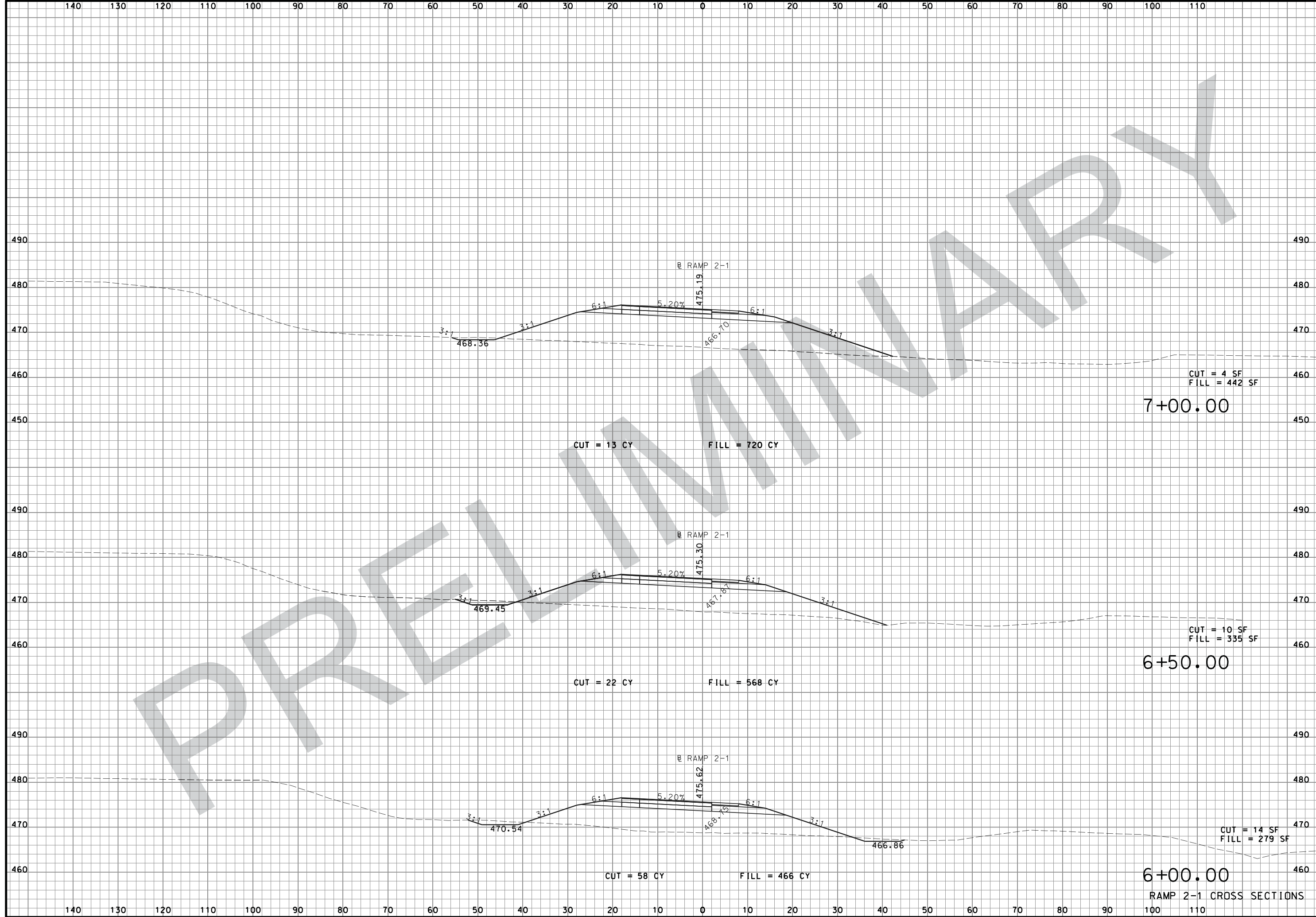

"THIS MEDIA SHOULD NOT BE CONSIDERED A CERTIFIED DOCUMENT."

DATE PREPARED
08-FEB-2018

ROUTE	STATE
I-44	MO
DISTRICT	SHEET NO.
SL	XS36

COUNTY
ST. LOUIS

JOB NO.
J613029

CONTRACT ID.

PROJECT NO.

BRIDGE NO.

DESCRIPTION	DATE

MISSOURI HIGHWAYS AND TRANSPORTATION COMMISSION

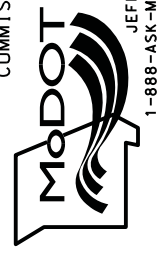

105 WEST CAPITOL
JEFFERSON CITY, MO 65102
1-888-ASK-MODOT (1-888-275-6636)

JACOBS

JACOBS ENGINEERING GROUP
501 NORTH BROADWAY
ST. LOUIS, MISSOURI 63102-2121
PHONE: (314) 335-4000
CERTIFICATE OF AUTHORITY #00704

IF A SEAL IS PRESENT ON THIS SHEET IT HAS BEEN ELECTRONICALLY SEALED AND DATED:

RAMP 2-1 CROSS SECTIONS

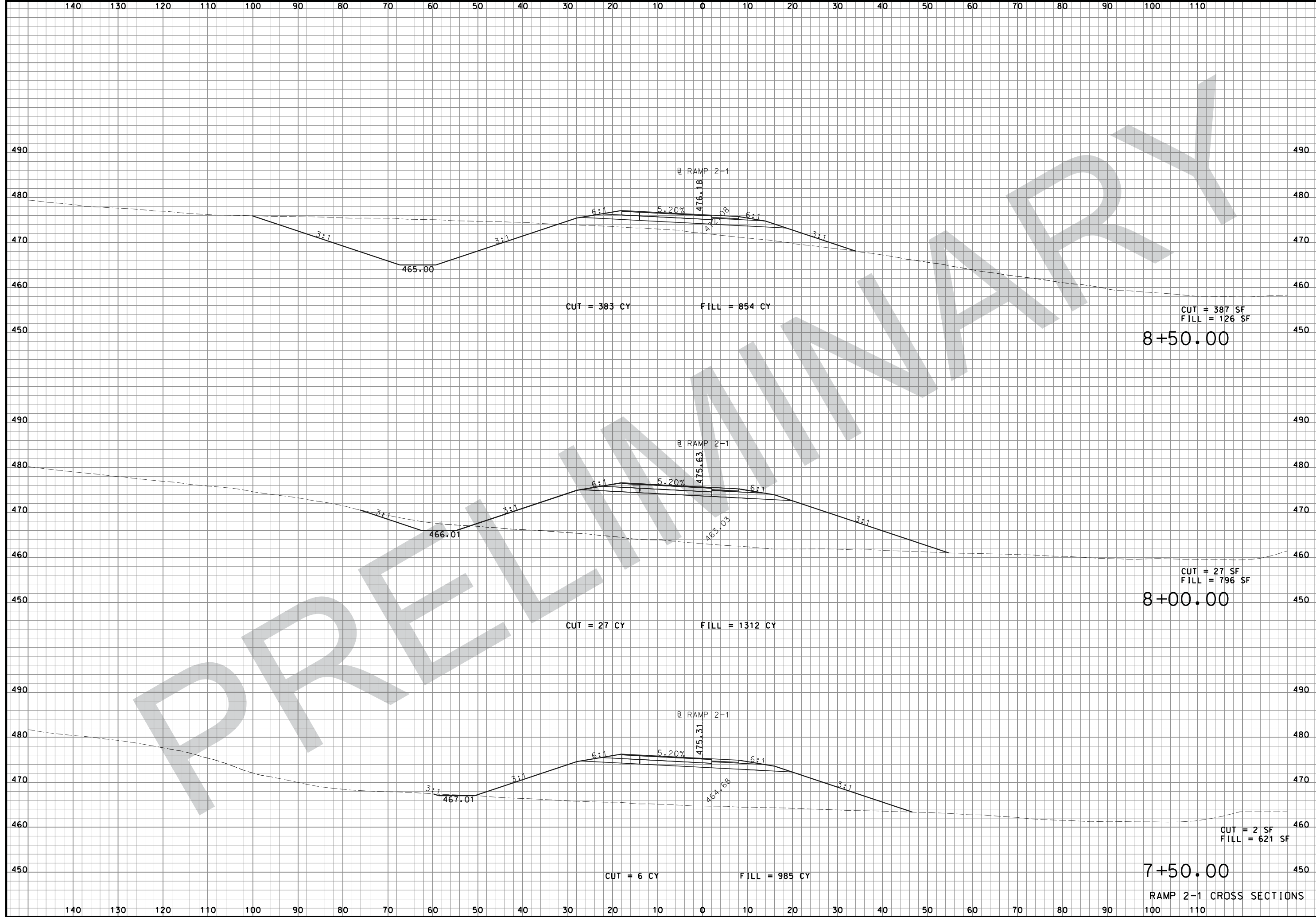

"THIS MEDIA SHOULD NOT BE CONSIDERED A CERTIFIED DOCUMENT."

DATE PREPARED
08-FEB-2018

ROUTE STATE
I-44 MO

DISTRICT SHEET NO.
SL XS37

COUNTY
ST. LOUIS

JOB NO.
J613029

CONTRACT ID.

PROJECT NO.

BRIDGE NO.

DATE	DESCRIPTION

MISSOURI HIGHWAYS AND TRANSPORTATION COMMISSION



JACOBS
 JACOBS ENGINEERING GROUP
 501 NORTH BROADWAY
 ST. LOUIS, MISSOURI 63102-2121
 PHONE: (314) 335-4000
 CERTIFICATE OF AUTHORITY #00704

IF A SEAL IS PRESENT ON THIS SHEET IT HAS BEEN ELECTRONICALLY SEALED AND DATED:

RAMP 2-1 CROSS SECTIONS

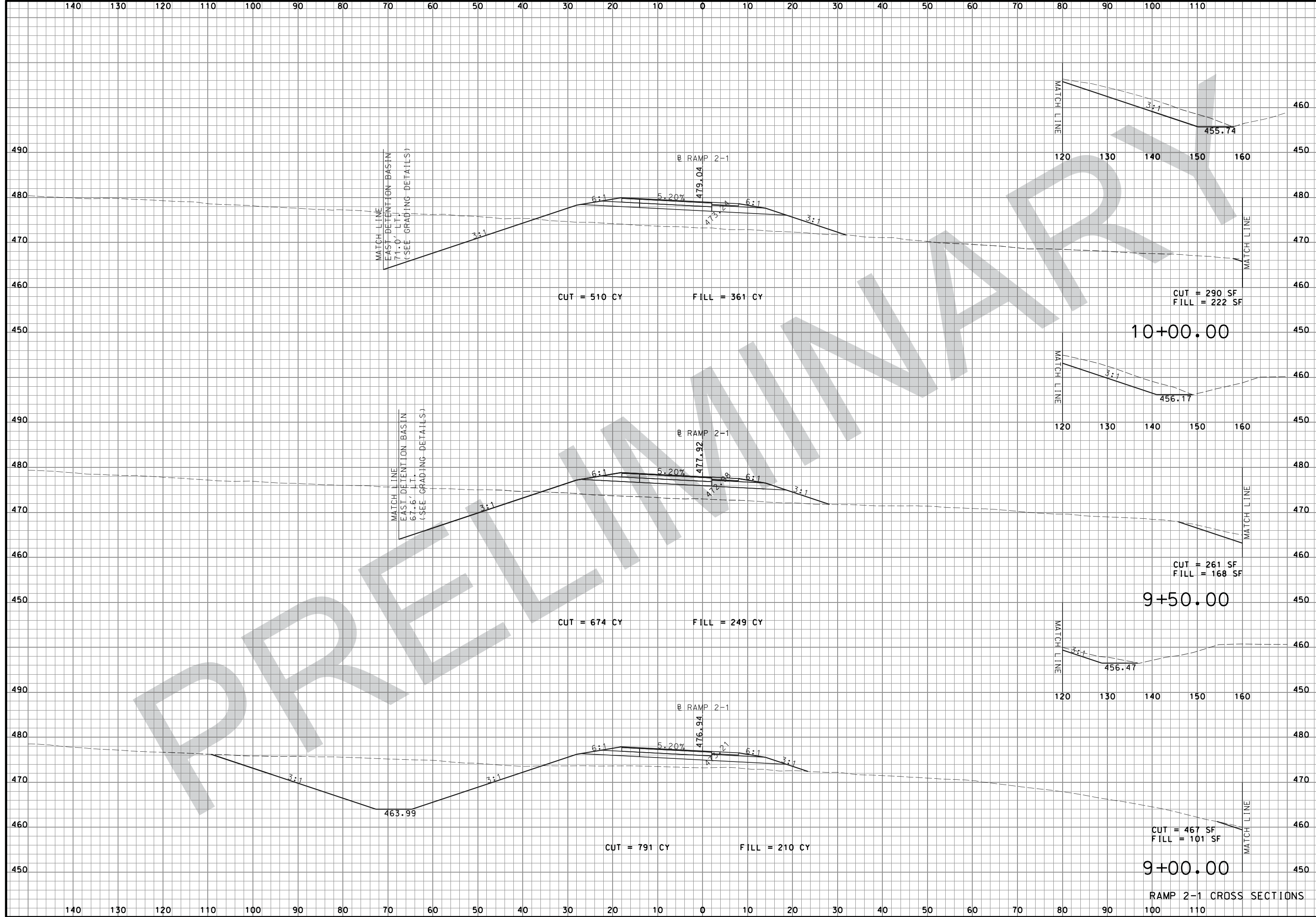

"THIS MEDIA SHOULD NOT BE CONSIDERED A CERTIFIED DOCUMENT."

DATE PREPARED 08-FEB-2018	
ROUTE I-44	STATE MO
DISTRICT SL	SHEET NO. XS38
COUNTY ST. LOUIS	
JOB NO. J613029	
CONTRACT ID.	
PROJECT NO.	
BRIDGE NO.	

DATE	DESCRIPTION

MISSOURI HIGHWAYS AND TRANSPORTATION COMMISSION

105 WEST CAPITOL
JEFFERSON CITY, MO 65102
1-888-ASK-MODOT (1-888-275-6636)

JACOBS ENGINEERING GROUP
501 NORTH BROADWAY
ST. LOUIS, MISSOURI 63102-2121
PHONE: (314) 335-4000
CERTIFICATE OF AUTHORITY #00704

RAMP 2-1 CROSS SECTIONS

IF A SEAL IS PRESENT ON THIS SHEET IT HAS BEEN ELECTRONICALLY SEALED AND DATED:

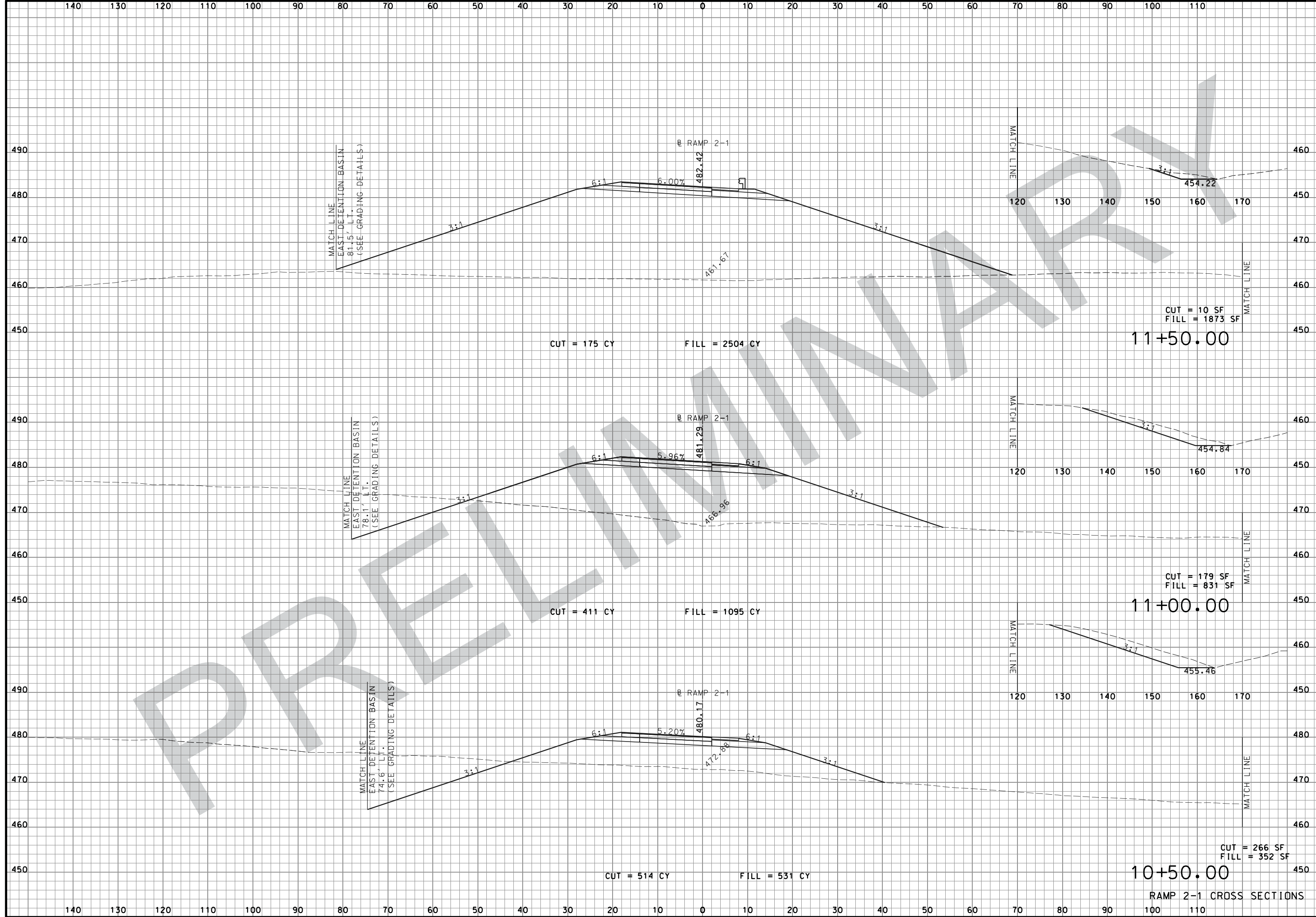

"THIS MEDIA SHOULD NOT BE CONSIDERED A CERTIFIED DOCUMENT."

DATE PREPARED 08-FEB-2018	
ROUTE I-44	STATE MO
DISTRICT SL	SHEET NO. XS39
COUNTY ST. LOUIS	
JOB NO. J613029	
CONTRACT ID.	
PROJECT NO.	
BRIDGE NO.	

DATE	DESCRIPTION

MISSOURI HIGHWAYS AND TRANSPORTATION COMMISSION

105 WEST CAPITOL
JEFFERSON CITY, MO 65102
1-888-ASK-MODOT (1-888-275-6636)

JACOBS ENGINEERING GROUP
501 NORTH BROADWAY
ST. LOUIS, MISSOURI 63102-2121
PHONE: (314) 335-4000
CERTIFICATE OF AUTHORITY #00704

RAMP 2-1 CROSS SECTIONS

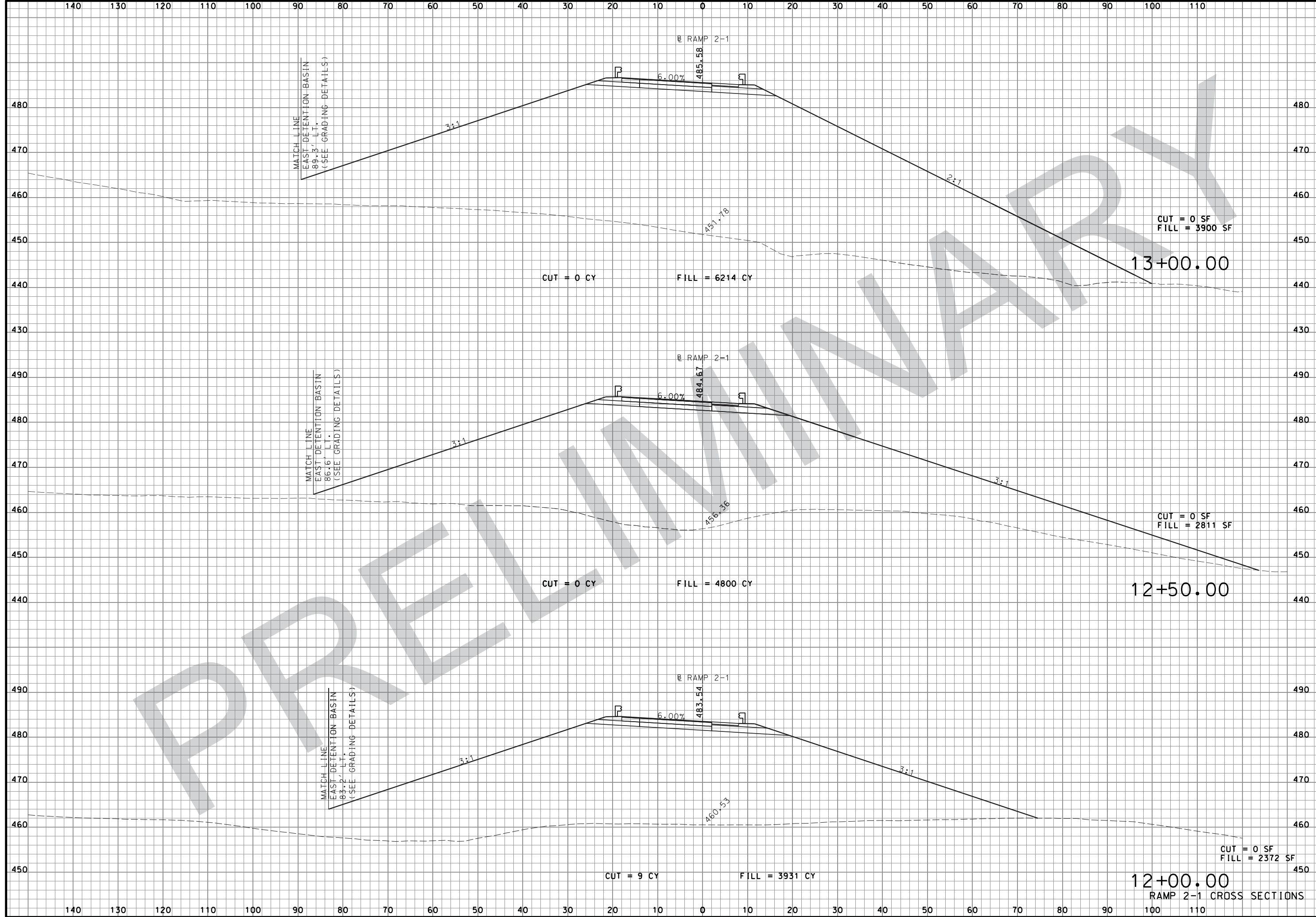

"THIS MEDIA SHOULD NOT BE CONSIDERED A CERTIFIED DOCUMENT."

DATE PREPARED 08-FEB-2018	
ROUTE I-44	STATE MO
DISTRICT SL	SHEET NO. XS40
COUNTY ST. LOUIS	
JOB NO. J613029	
CONTRACT ID.	
PROJECT NO.	
BRIDGE NO.	

DATE	DESCRIPTION

MISSOURI HIGHWAYS AND TRANSPORTATION COMMISSION

105 WEST CAPITOL
JEFFERSON CITY, MO 65102
1-888-ASK-MODOT (1-888-275-6636)

JACOBS ENGINEERING GROUP
501 NORTH BROADWAY
ST. LOUIS, MISSOURI 63102-2121
PHONE: (314) 335-4000
CERTIFICATE OF AUTHORITY #00704

RAMP 2-1 CROSS SECTIONS

IF A SEAL IS PRESENT ON THIS SHEET IT HAS BEEN ELECTRONICALLY SEALED AND DATED:

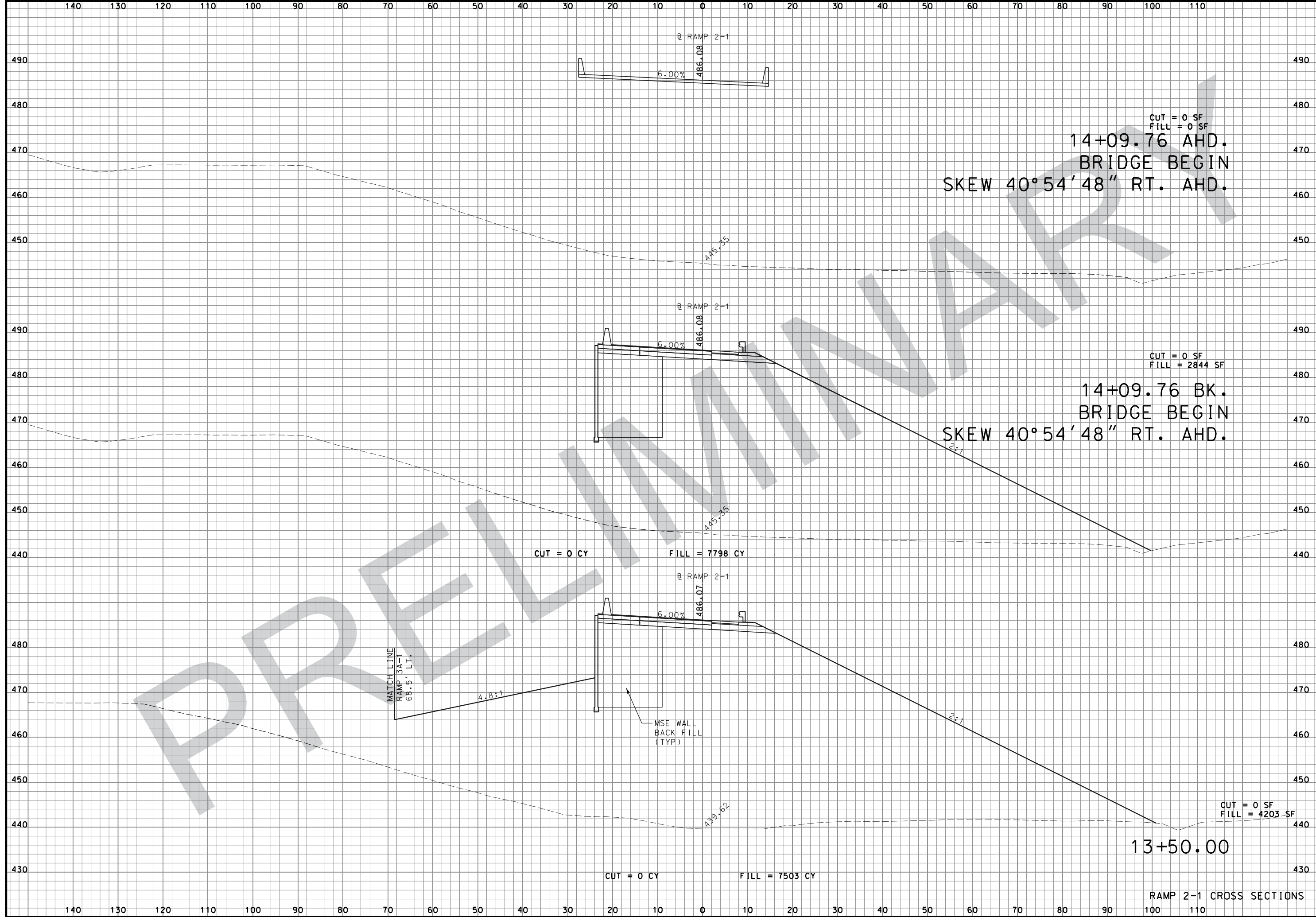

"THIS MEDIA SHOULD NOT BE CONSIDERED A CERTIFIED DOCUMENT."

DATE PREPARED
08-FEB-2018

ROUTE I-44	STATE MO
DISTRICT SL	SHEET NO. XS41

COUNTY
ST. LOUIS

JOB NO.
J613029

CONTRACT ID.

PROJECT NO.

BRIDGE NO.

DATE	DESCRIPTION

MISSOURI HIGHWAYS AND TRANSPORTATION COMMISSION

105 WEST CAPITOL
JEFFERSON CITY, MO 65102
1-888-ASK-MODOT (1-888-275-6636)

JACOBS

JACOBS ENGINEERING GROUP
501 NORTH BROADWAY
ST. LOUIS, MISSOURI 63102-2121
PHONE: (314) 335-4000
CERTIFICATE OF AUTHORITY #00704

IF A SEAL IS PRESENT ON THIS SHEET IT HAS BEEN ELECTRONICALLY SEALED AND DATED:

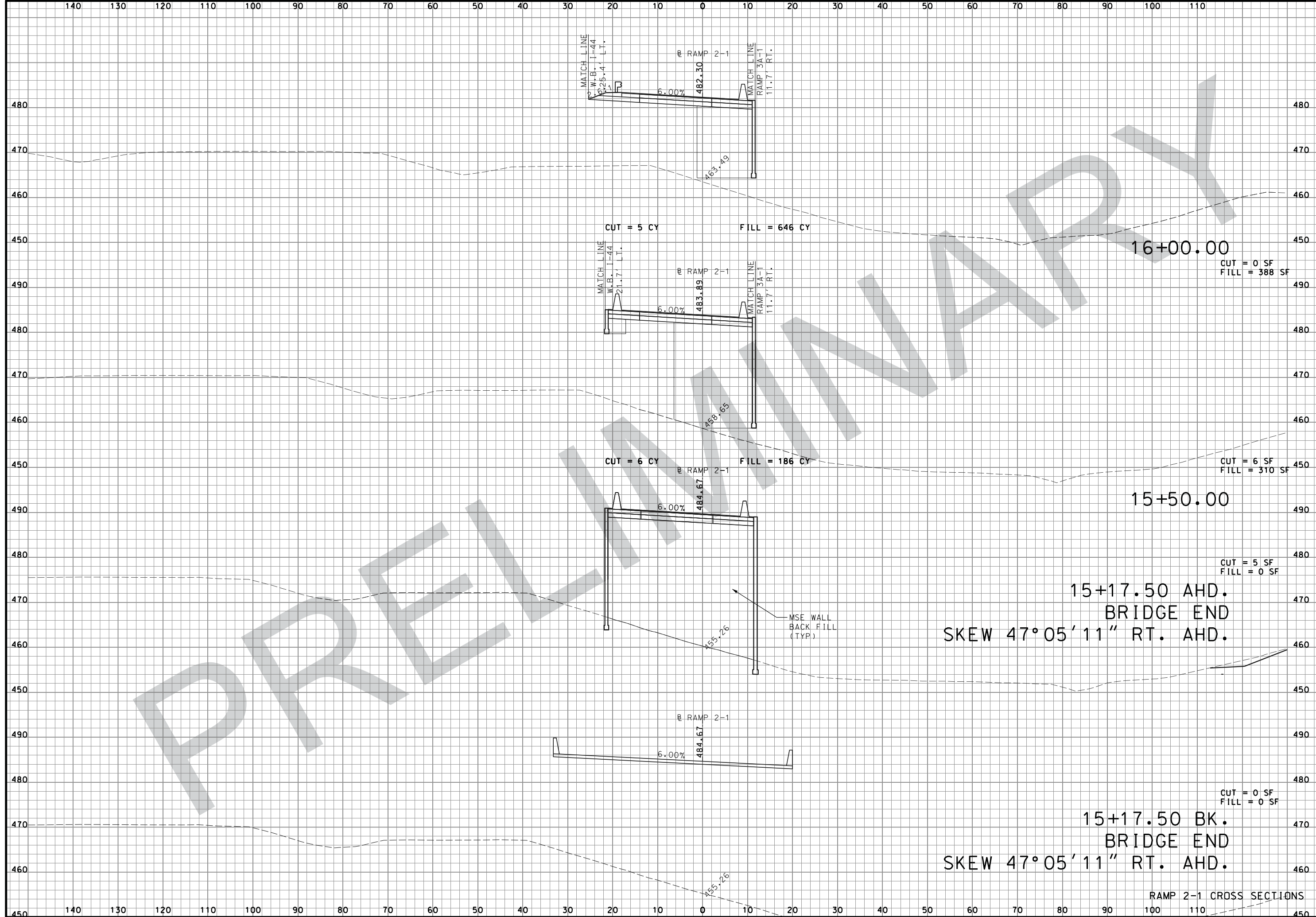

"THIS MEDIA SHOULD NOT BE CONSIDERED A CERTIFIED DOCUMENT."

DATE PREPARED 08-FEB-2018	
ROUTE I-44	STATE MO
DISTRICT SL	SHEET NO. XS42
COUNTY ST. LOUIS	
JOB NO. J613029	
CONTRACT ID.	
PROJECT NO.	
BRIDGE NO.	

DATE	DESCRIPTION

MISSOURI HIGHWAYS AND TRANSPORTATION COMMISSION

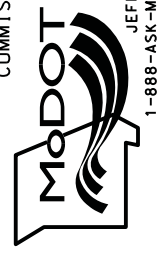

105 WEST CAPITOL
JEFFERSON CITY, MO 65102
1-888-ASK-MODOT (1-888-275-6636)

JACOBS

JACOBS ENGINEERING GROUP
501 NORTH BROADWAY
ST. LOUIS, MISSOURI 63102-2121
PHONE: (314) 335-4000
CERTIFICATE OF AUTHORITY #00704

IF A SEAL IS PRESENT ON THIS SHEET IT HAS BEEN ELECTRONICALLY SEALED AND DATED:

15+17.50 AHD.
BRIDGE END
SKEW 47°05'11" RT. AHD.

15+17.50 BK.
BRIDGE END
SKEW 47°05'11" RT. AHD.

16+00.00

CUT = 0 SF
FILL = 388 SF

CUT = 5 CY
FILL = 646 CY

CUT = 6 CY
FILL = 186 CY

CUT = 6 SF
FILL = 310 SF

CUT = 5 SF
FILL = 0 SF

CUT = 0 SF
FILL = 0 SF

RAMP 2-1 CROSS SECTIONS

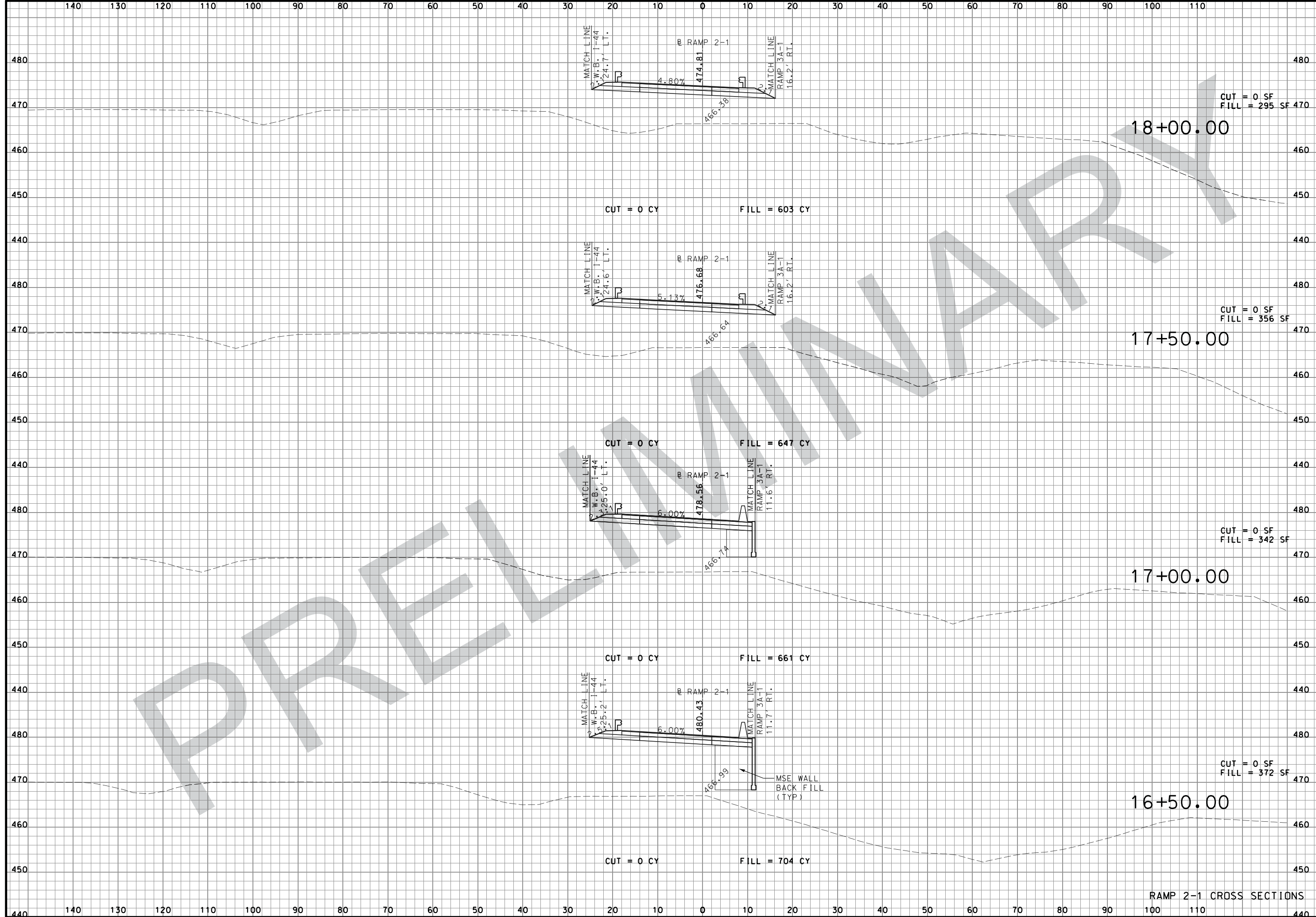

"THIS MEDIA SHOULD NOT BE CONSIDERED A CERTIFIED DOCUMENT."

DATE PREPARED 08-FEB-2018	
ROUTE I-44	STATE MO
DISTRICT SL	SHEET NO. XS43
COUNTY ST. LOUIS	
JOB NO. J613029	
CONTRACT ID.	

PROJECT NO.
BRIDGE NO.

DATE	DESCRIPTION

MISSOURI HIGHWAYS AND TRANSPORTATION COMMISSION

105 WEST CAPITOL
JEFFERSON CITY, MO 65102
1-888-ASK-MODOT (1-888-275-6636)

JACOBS ENGINEERING GROUP
501 NORTH BROADWAY
ST. LOUIS, MISSOURI 63102-2121
PHONE: (314) 335-4000
CERTIFICATE OF AUTHORITY #00704

IF A SEAL IS PRESENT ON THIS SHEET IT HAS BEEN ELECTRONICALLY SEALED AND DATED:

RAMP 2-1 CROSS SECTIONS

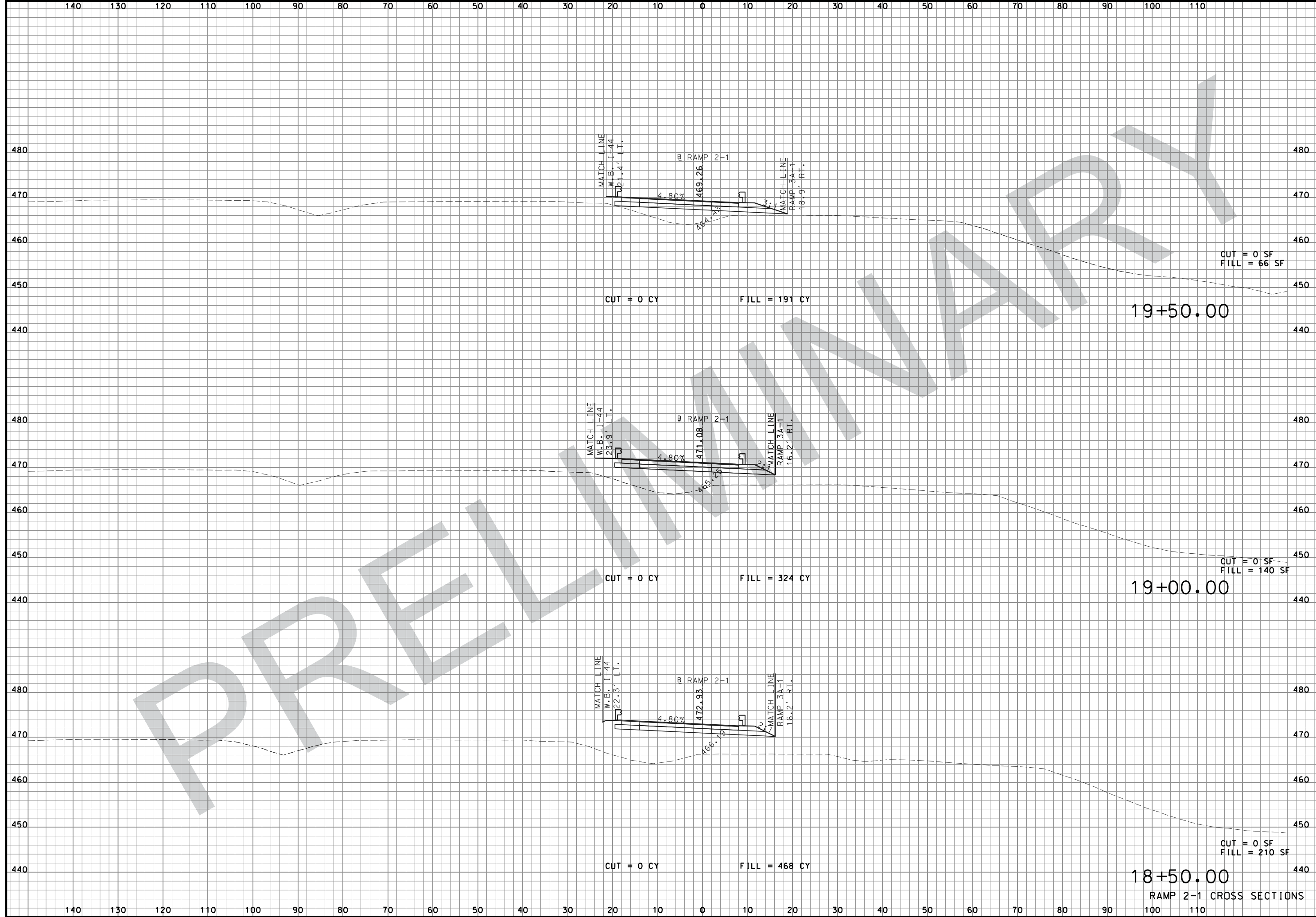

"THIS MEDIA SHOULD NOT BE CONSIDERED A CERTIFIED DOCUMENT."

DATE PREPARED
08-FEB-2018

ROUTE STATE
I-44 MO

DISTRICT SHEET NO.
SL XS44

COUNTY
ST. LOUIS

JOB NO.
J613029

CONTRACT ID.

PROJECT NO.

BRIDGE NO.

DATE	DESCRIPTION

MISSOURI HIGHWAYS AND TRANSPORTATION COMMISSION

MODOT

105 WEST CAPITOL
JEFFERSON CITY, MO 65102
1-888-ASK-MODOT (1-888-275-6636)

JACOBS

JACOBS ENGINEERING GROUP
501 NORTH BROADWAY
ST. LOUIS, MISSOURI 63102-2121
PHONE: (314) 335-4000
CERTIFICATE OF AUTHORITY #00704

IF A SEAL IS PRESENT ON THIS SHEET IT HAS BEEN ELECTRONICALLY SEALED AND DATED.

18+50.00
19+00.00
19+50.00
RAMP 2-1 CROSS SECTIONS

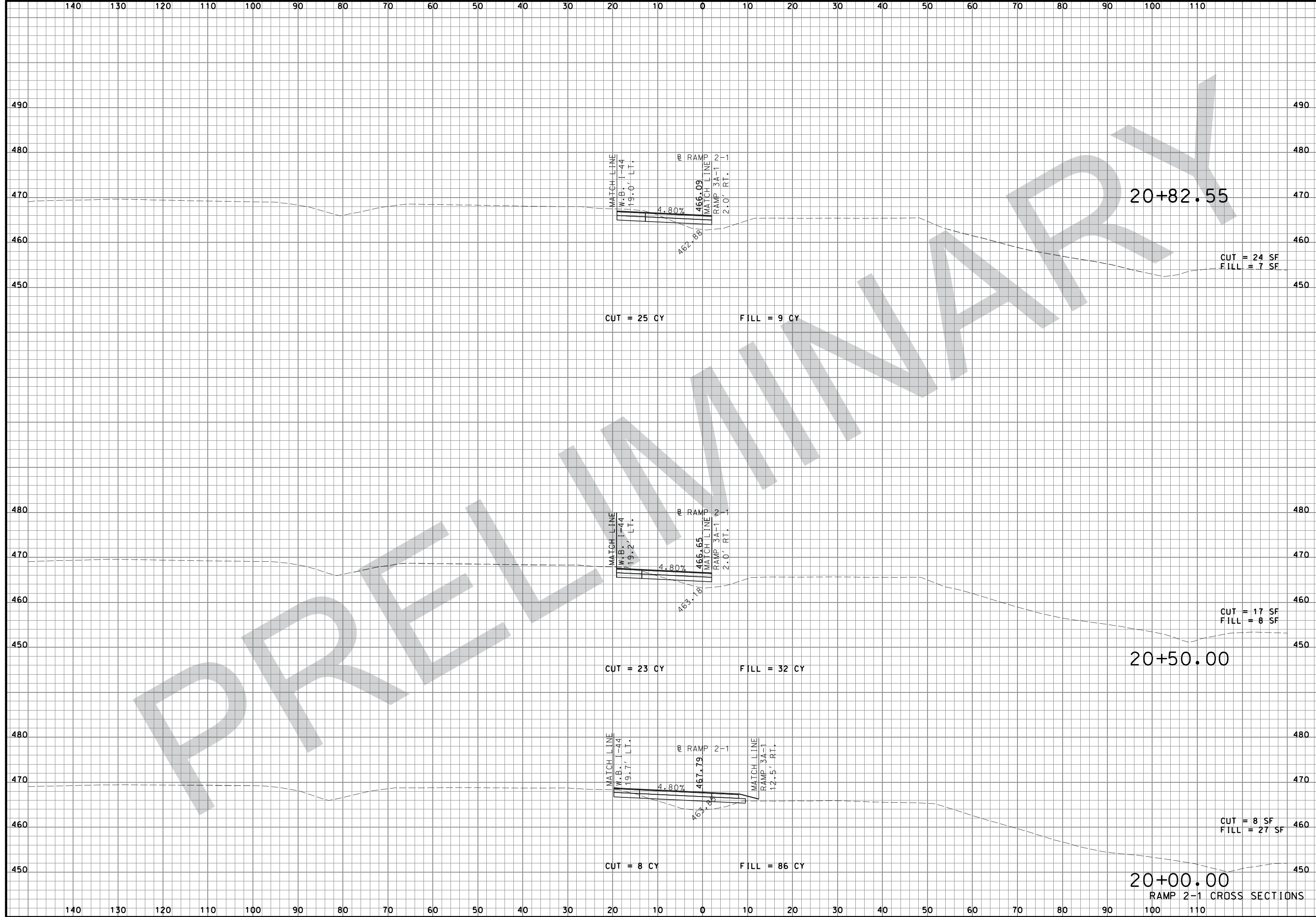

"THIS MEDIA SHOULD NOT BE CONSIDERED A CERTIFIED DOCUMENT."

DATE PREPARED
08-FEB-2018

ROUTE STATE
I-44 MO

DISTRICT SHEET NO.
SL XS45

COUNTY
ST. LOUIS

JOB NO.
J613029

CONTRACT ID.

PROJECT NO.

BRIDGE NO.

DATE	DESCRIPTION

MISSOURI HIGHWAYS AND TRANSPORTATION COMMISSION



105 WEST CAPITOL
JEFFERSON CITY, MO 65102
1-888-ASK-MODOT (1-888-275-6636)

JACOBS

JACOBS ENGINEERING GROUP
501 NORTH BROADWAY
ST. LOUIS, MISSOURI 63102-2121
PHONE: (314) 335-4000
CERTIFICATE OF AUTHORITY #00704

IF A SEAL IS PRESENT ON THIS SHEET IT HAS BEEN ELECTRONICALLY SEALED AND DATED:

20+82.55

20+50.00

20+00.00

CUT = 24 SF
FILL = 7 SF

CUT = 17 SF
FILL = 8 SF

CUT = 8 SF
FILL = 27 SF

CUT = 25 CY

FILL = 9 CY

CUT = 23 CY

FILL = 32 CY

CUT = 8 CY

FILL = 86 CY

RAMP 2-1 CROSS SECTIONS

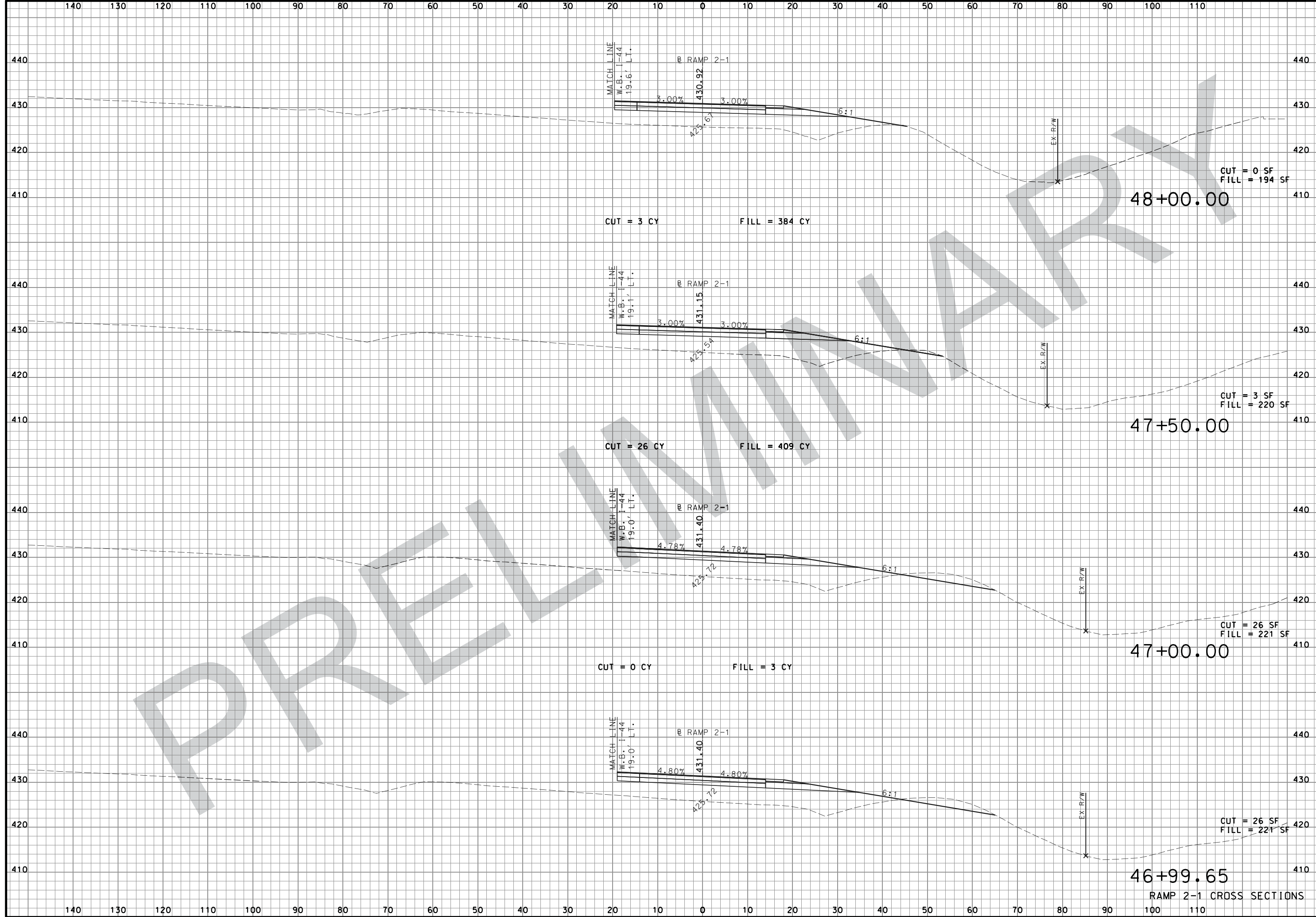

"THIS MEDIA SHOULD NOT BE CONSIDERED A CERTIFIED DOCUMENT."

DATE PREPARED 08-FEB-2018	
ROUTE I-44	STATE MO
DISTRICT SL	SHEET NO. XS46
COUNTY ST. LOUIS	
JOB NO. J613029	
CONTRACT ID.	

PROJECT NO.
BRIDGE NO.

DATE	DESCRIPTION

MISSOURI HIGHWAYS AND TRANSPORTATION COMMISSION

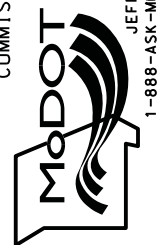

105 WEST CAPITOL
JEFFERSON CITY, MO 65102
1-888-ASK-MODOT (1-888-275-6636)



JACOBS ENGINEERING GROUP
501 NORTH BROADWAY
ST. LOUIS, MISSOURI 63102-2121
PHONE: (314) 335-4000
CERTIFICATE OF AUTHORITY #00704

IF A SEAL IS PRESENT ON THIS SHEET IT HAS BEEN ELECTRONICALLY SEALED AND DATED:

RAMP 2-1 CROSS SECTIONS

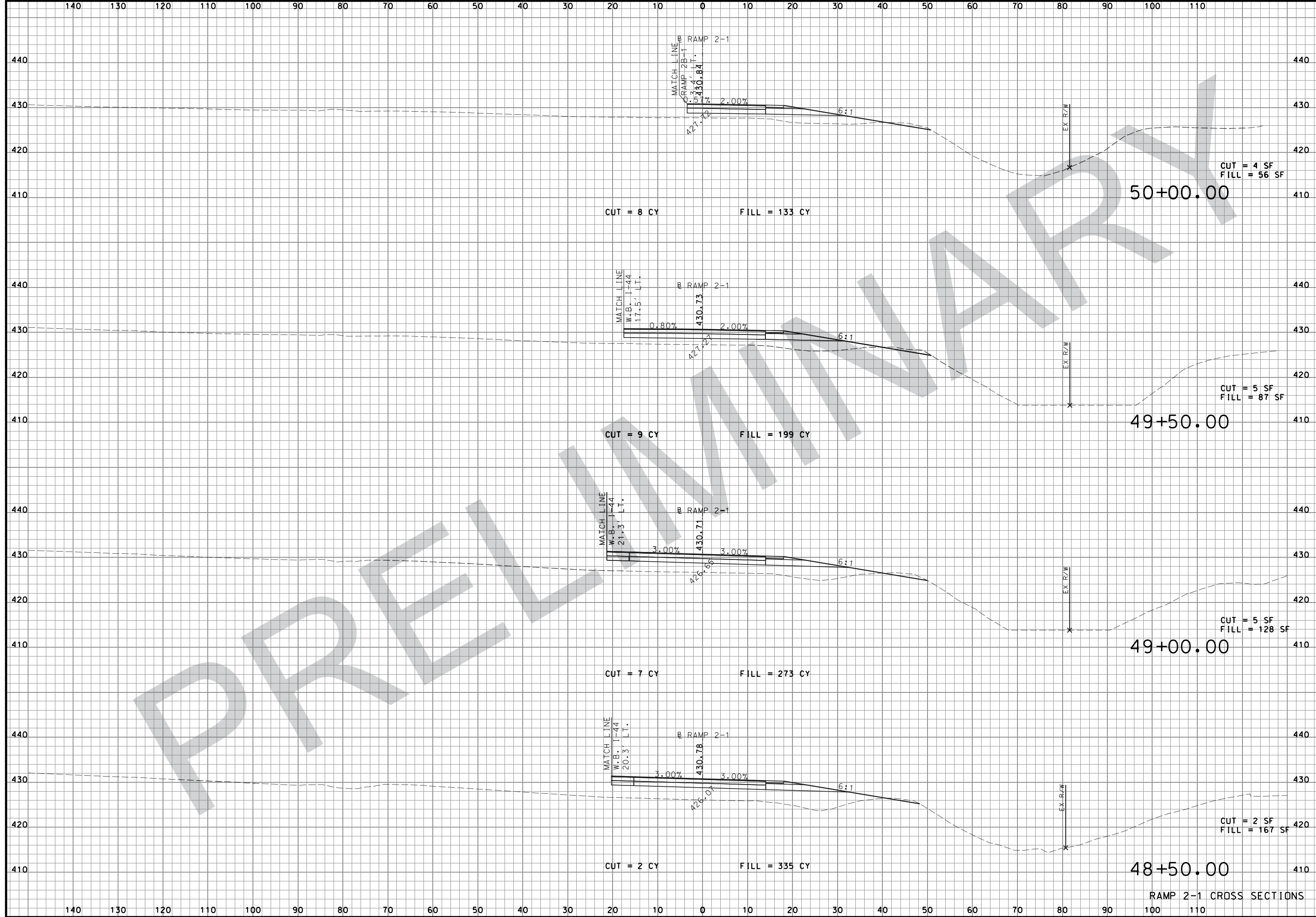

"THIS MEDIA SHOULD NOT BE CONSIDERED A CERTIFIED DOCUMENT."

DATE PREPARED: 08-FEB-2018

ROUTE: I-44	STATE: MO
DISTRICT: SL	SHEET NO.: XS47

COUNTY: ST. LOUIS
 JOB NO.: J613029
 CONTRACT ID.:

PROJECT NO.:

BRIDGE NO.:

DATE	DESCRIPTION

MISSOURI HIGHWAYS AND TRANSPORTATION COMMISSION

105 WEST CAPITOL
 JEFFERSON CITY, MO 65102
 1-888-ASK-MODOT (1-888-275-6636)

JACOBS
 JACOBS ENGINEERING GROUP
 501 NORTH BROADWAY
 ST. LOUIS, MISSOURI 63102-2121
 PHONE: (314) 335-4000
 CERTIFICATE OF AUTHORITY #00704

RAMP 2-1 CROSS SECTIONS

IF A SEAL IS PRESENT ON THIS SHEET IT HAS BEEN ELECTRONICALLY SEALED AND DATED:

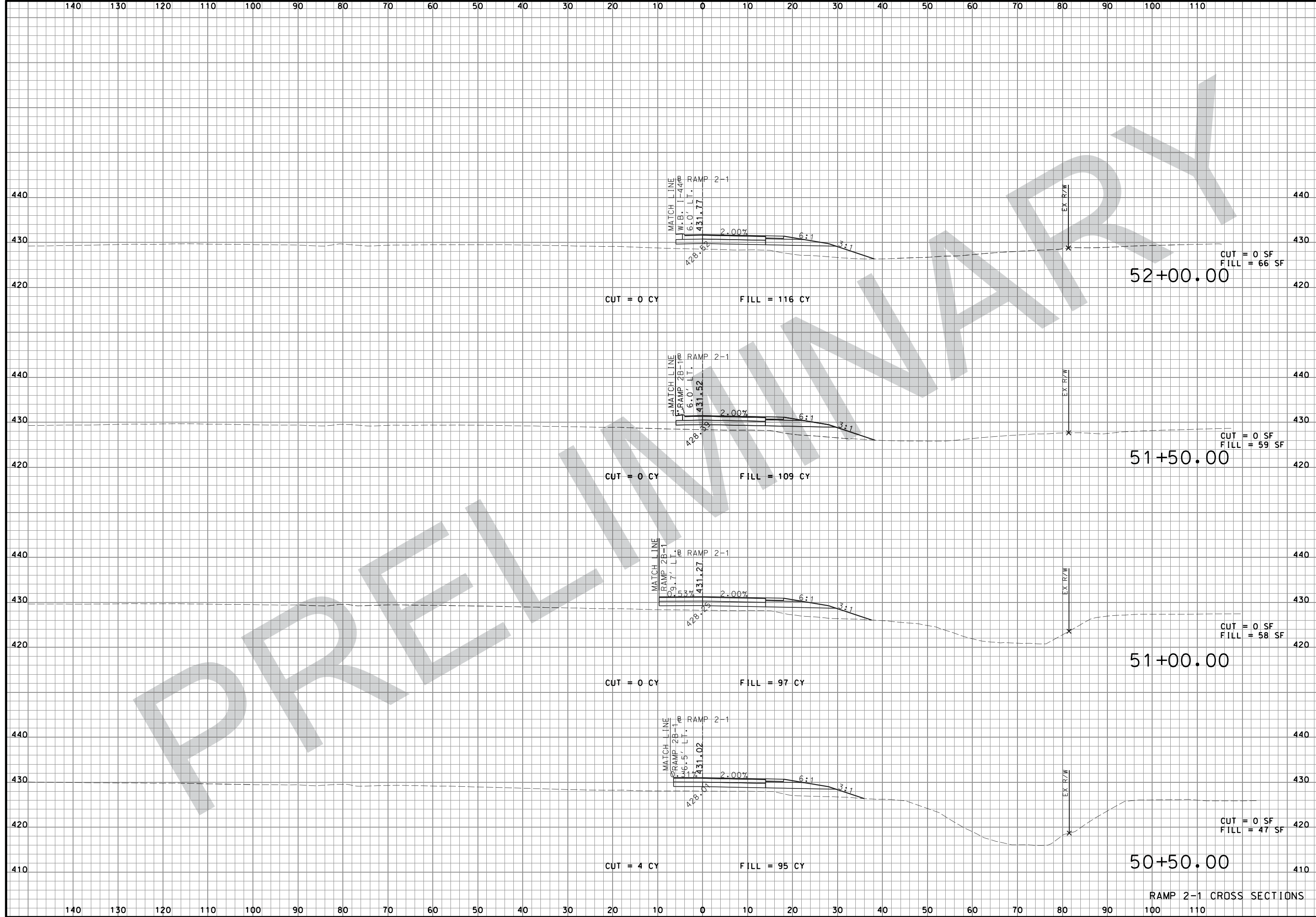

"THIS MEDIA SHOULD NOT BE CONSIDERED A CERTIFIED DOCUMENT."

DATE PREPARED
08-FEB-2018

ROUTE	STATE
I-44	MO
DISTRICT	SHEET NO.
SL	XS48

COUNTY
ST. LOUIS

JOB NO.
J613029

CONTRACT ID.

PROJECT NO.

BRIDGE NO.

DATE	DESCRIPTION

MISSOURI HIGHWAYS AND TRANSPORTATION COMMISSION

105 WEST CAPITOL
JEFFERSON CITY, MO 65102
1-888-ASK-MODOT (1-888-275-6636)

JACOBS

JACOBS ENGINEERING GROUP
501 NORTH BROADWAY
ST. LOUIS, MISSOURI 63102-2121
PHONE: (314) 335-4000
CERTIFICATE OF AUTHORITY #00704

IF A SEAL IS PRESENT ON THIS SHEET IT HAS BEEN ELECTRONICALLY SEALED AND DATED:

RAMP 2-1 CROSS SECTIONS

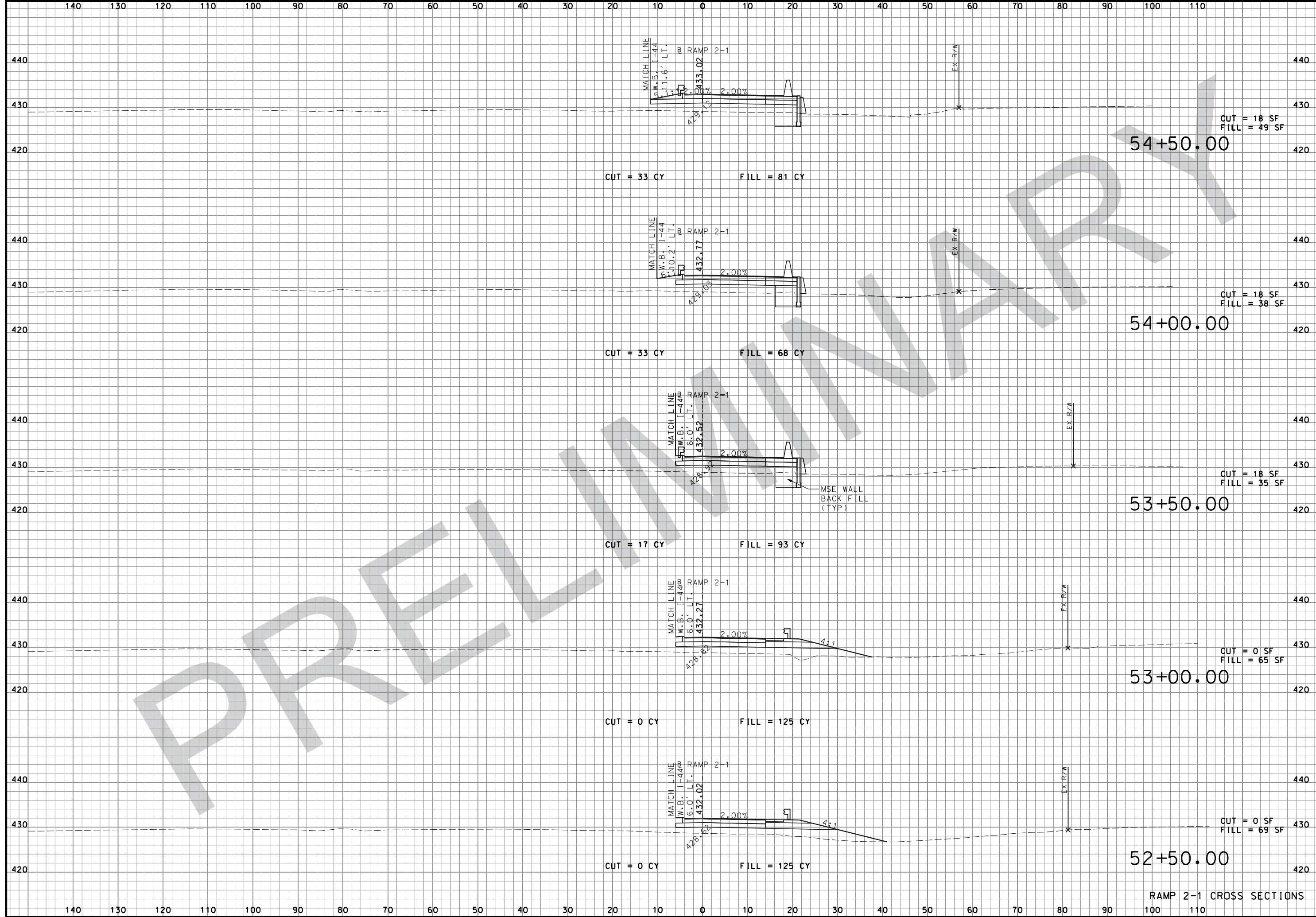

"THIS MEDIA SHOULD NOT BE CONSIDERED A CERTIFIED DOCUMENT."

DATE PREPARED 08-FEB-2018	
ROUTE I-44	STATE MO
DISTRICT SL	SHEET NO. XS49
COUNTY ST. LOUIS	
JOB NO. J613029	
CONTRACT ID.	
PROJECT NO.	
BRIDGE NO.	

DATE	DESCRIPTION

MISSOURI HIGHWAYS AND TRANSPORTATION COMMISSION

MODOT

105 WEST CAPITOL
JEFFERSON CITY, MO 65102
1-888-ASK-MODOT (1-888-275-6636)

JACOBS
 JACOBS ENGINEERING GROUP
 501 NORTH BROADWAY
 ST. LOUIS, MISSOURI 63102-2121
 PHONE: (314) 335-4000
 CERTIFICATE OF AUTHORITY #00704

RAMP 2-1 CROSS SECTIONS

IF A SEAL IS PRESENT ON THIS SHEET IT HAS BEEN ELECTRONICALLY SEALED AND DATED:

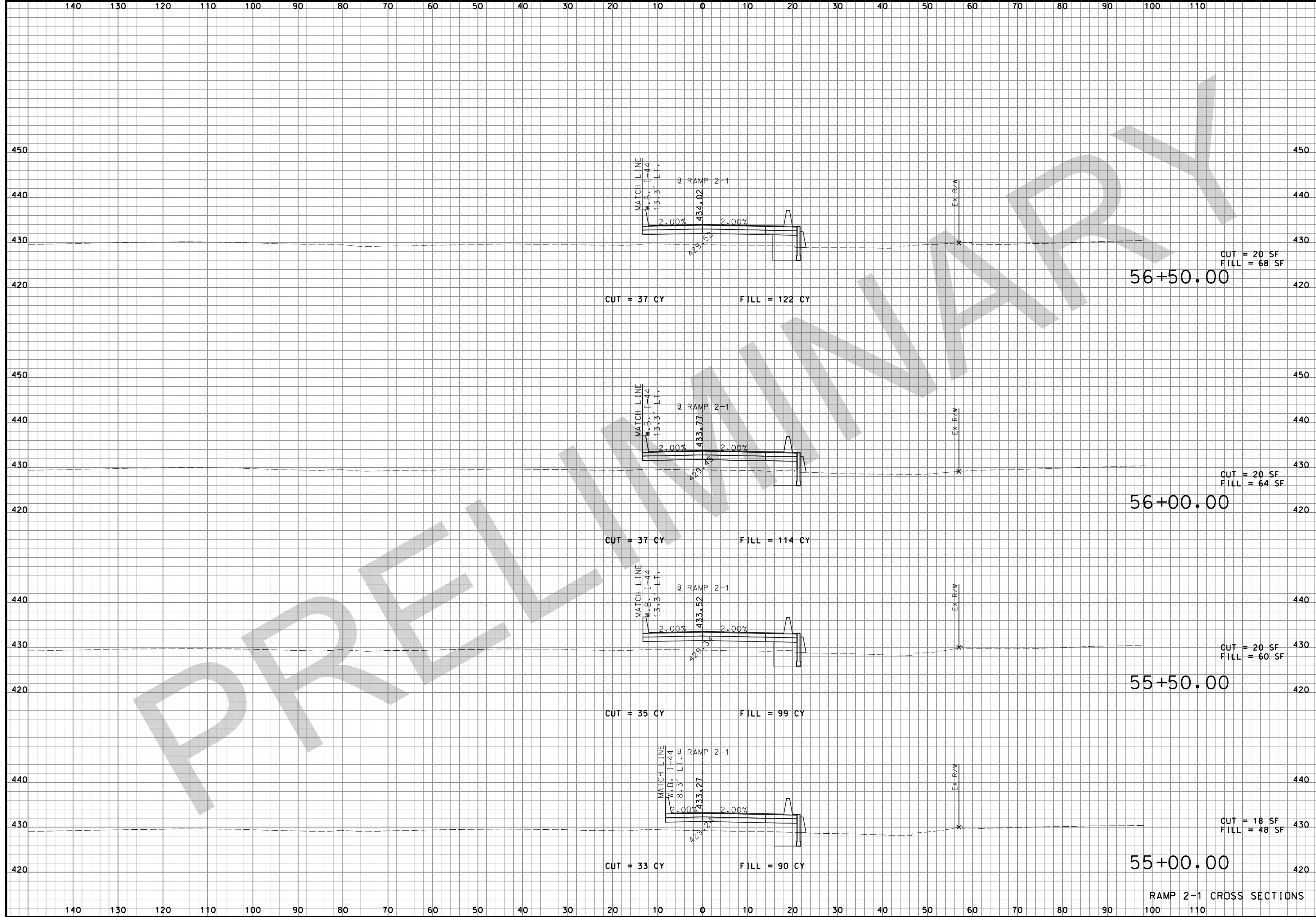

"THIS MEDIA SHOULD NOT BE CONSIDERED A CERTIFIED DOCUMENT."

DATE PREPARED
 08-FEB-2018

ROUTE	STATE
I-44	MO
DISTRICT	SHEET NO.
SL	XS50

COUNTY
 ST. LOUIS

JOB NO.
 J613029

CONTRACT ID.

PROJECT NO.
 BRIDGE NO.

DATE	DESCRIPTION

MISSOURI HIGHWAYS AND TRANSPORTATION COMMISSION



105 WEST CAPITOL
 JEFFERSON CITY, MO 65102
 1-888-ASK-MODOT (1-888-275-6636)

JACOBS

JACOBS ENGINEERING GROUP
 501 NORTH BROADWAY
 ST. LOUIS, MISSOURI 63102-2121
 PHONE: (314) 335-4000
 CERTIFICATE OF AUTHORITY #00704

IF A SEAL IS PRESENT ON THIS SHEET IT HAS BEEN ELECTRONICALLY SEALED AND DATED:

RAMP 2-1 CROSS SECTIONS

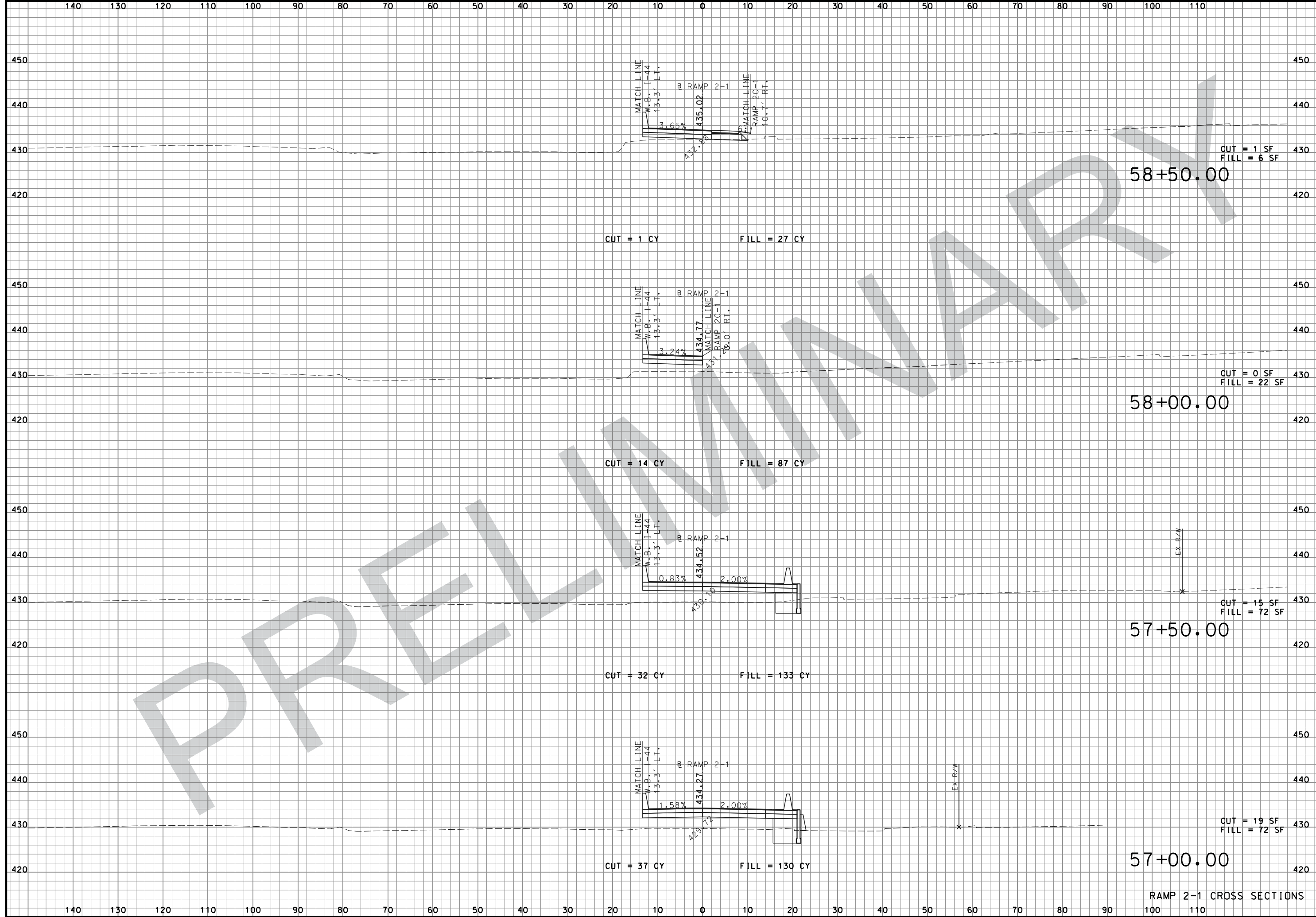

"THIS MEDIA SHOULD NOT BE CONSIDERED A CERTIFIED DOCUMENT."

DATE PREPARED: 08-FEB-2018

ROUTE: I-44	STATE: MO
DISTRICT: SL	SHEET NO.: XS51

COUNTY: ST. LOUIS
 JOB NO.: J613029
 CONTRACT ID.:

PROJECT NO.:

BRIDGE NO.:

DATE	DESCRIPTION

MISSOURI HIGHWAYS AND TRANSPORTATION COMMISSION

MODOT

105 WEST CAPITOL
 JEFFERSON CITY, MO 65102
 1-888-ASK-MODOT (1-888-275-6636)

JACOBS

JACOBS ENGINEERING GROUP
 501 NORTH BROADWAY
 ST. LOUIS, MISSOURI 63102-2121
 PHONE: (314) 335-4000
 CERTIFICATE OF AUTHORITY #00704

RAMP 2-1 CROSS SECTIONS

IF A SEAL IS PRESENT ON THIS SHEET IT HAS BEEN ELECTRONICALLY SEALED AND DATED:

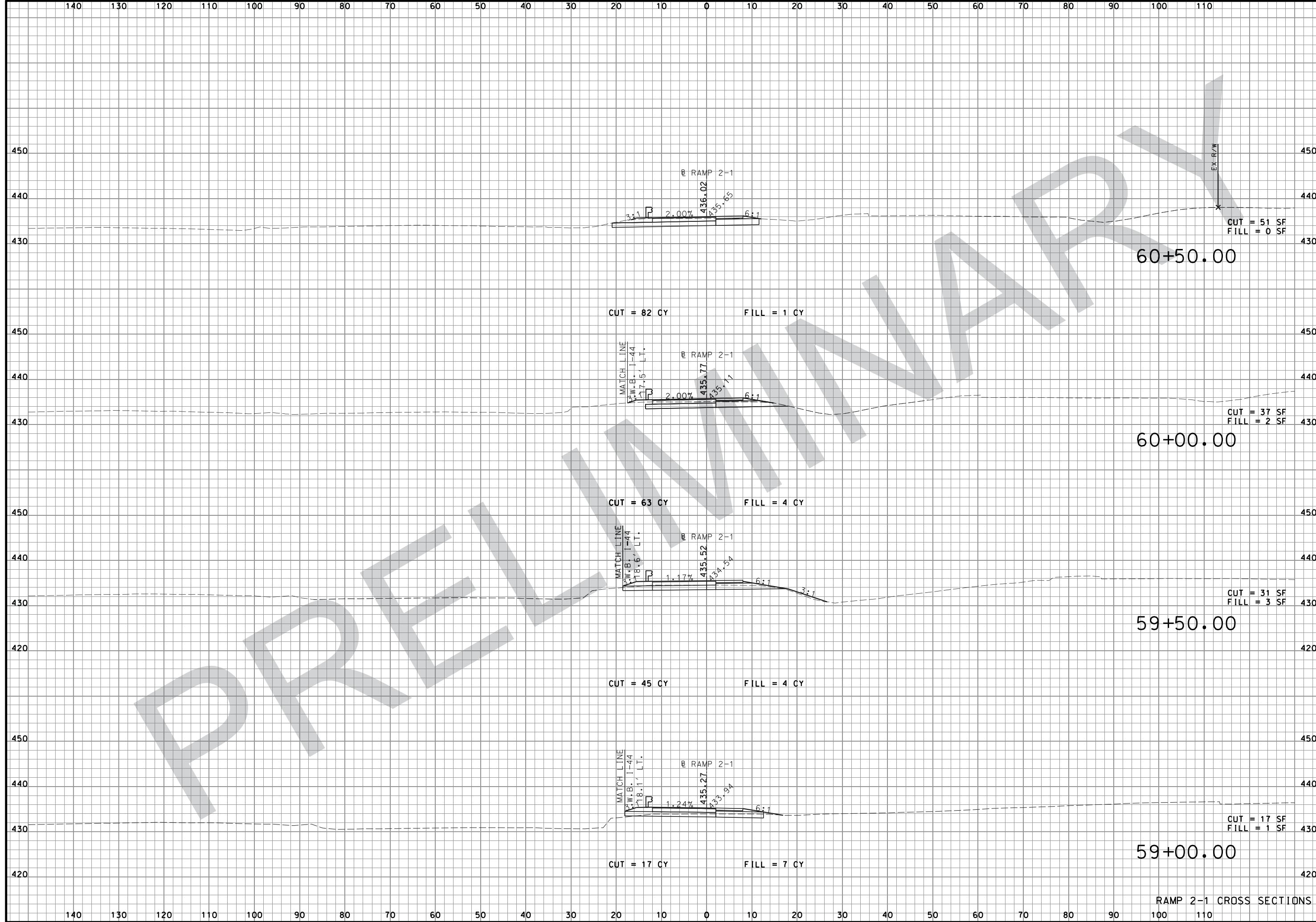

"THIS MEDIA SHOULD NOT BE CONSIDERED A CERTIFIED DOCUMENT."

DATE PREPARED 08-FEB-2018	
ROUTE I-44	STATE MO
DISTRICT SL	SHEET NO. XS52
COUNTY ST. LOUIS	
JOB NO. J613029	
CONTRACT ID.	
PROJECT NO.	
BRIDGE NO.	

DATE	DESCRIPTION

MISSOURI HIGHWAYS AND TRANSPORTATION COMMISSION



105 WEST CAPITOL
JEFFERSON CITY, MO 65102
1-888-ASK-MODOT (1-888-275-6636)

JACOBS

JACOBS ENGINEERING GROUP
501 NORTH BROADWAY
ST. LOUIS, MISSOURI 63102-2121
PHONE: (314) 335-4000
CERTIFICATE OF AUTHORITY #00704

IF A SEAL IS PRESENT ON THIS SHEET IT HAS BEEN ELECTRONICALLY SEALED AND DATED:

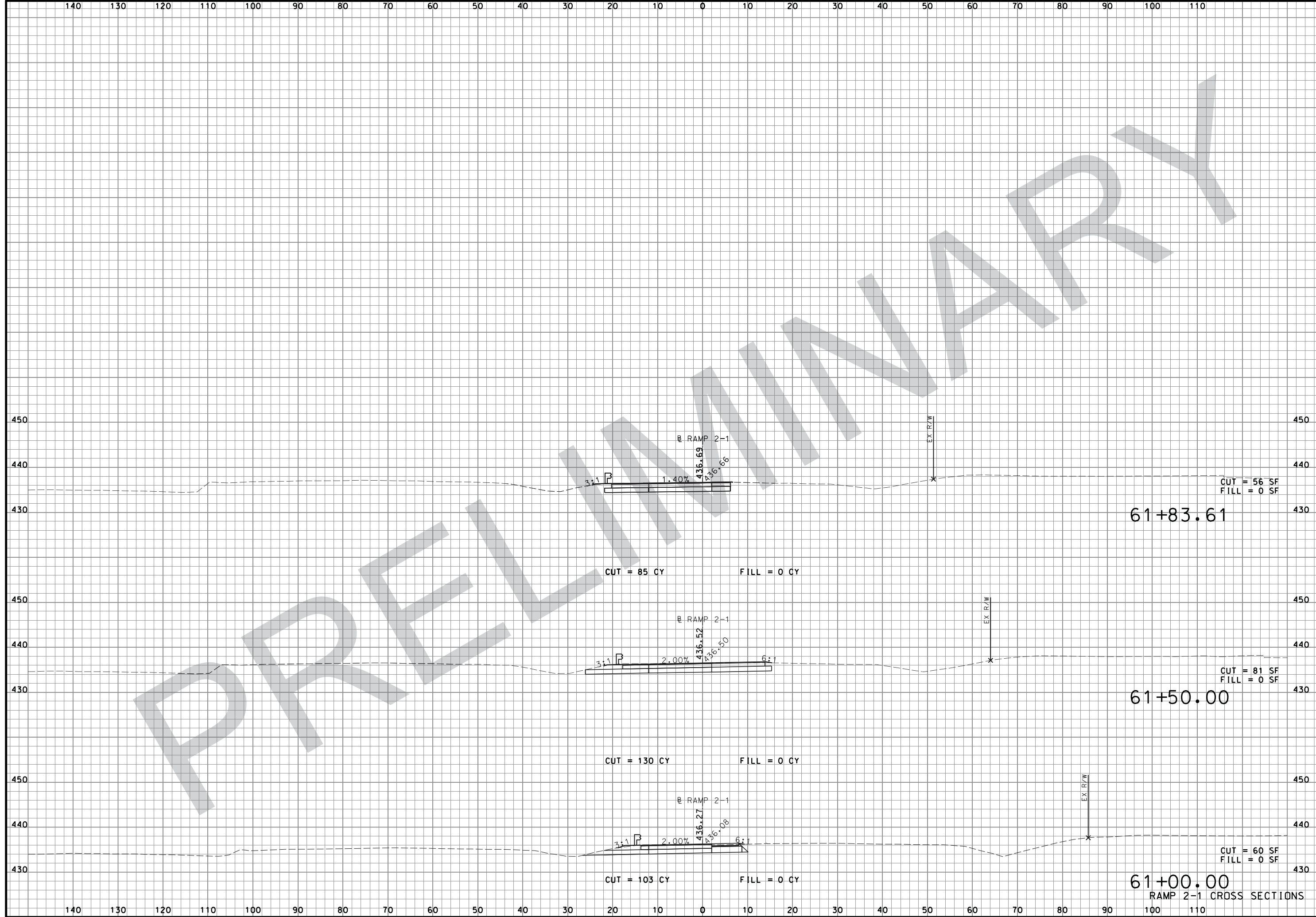

"THIS MEDIA SHOULD NOT BE CONSIDERED A CERTIFIED DOCUMENT."

DATE PREPARED
08-FEB-2018

ROUTE STATE
I-44 MO

DISTRICT SHEET NO.
SL XS53

COUNTY
ST. LOUIS

JOB NO.
J613029

CONTRACT ID.

PROJECT NO.

BRIDGE NO.

DATE	DESCRIPTION

MISSOURI HIGHWAYS AND TRANSPORTATION COMMISSION



IF A SEAL IS PRESENT ON THIS SHEET IT HAS BEEN ELECTRONICALLY SEALED AND DATED:

RAMP 2-1 CROSS SECTIONS

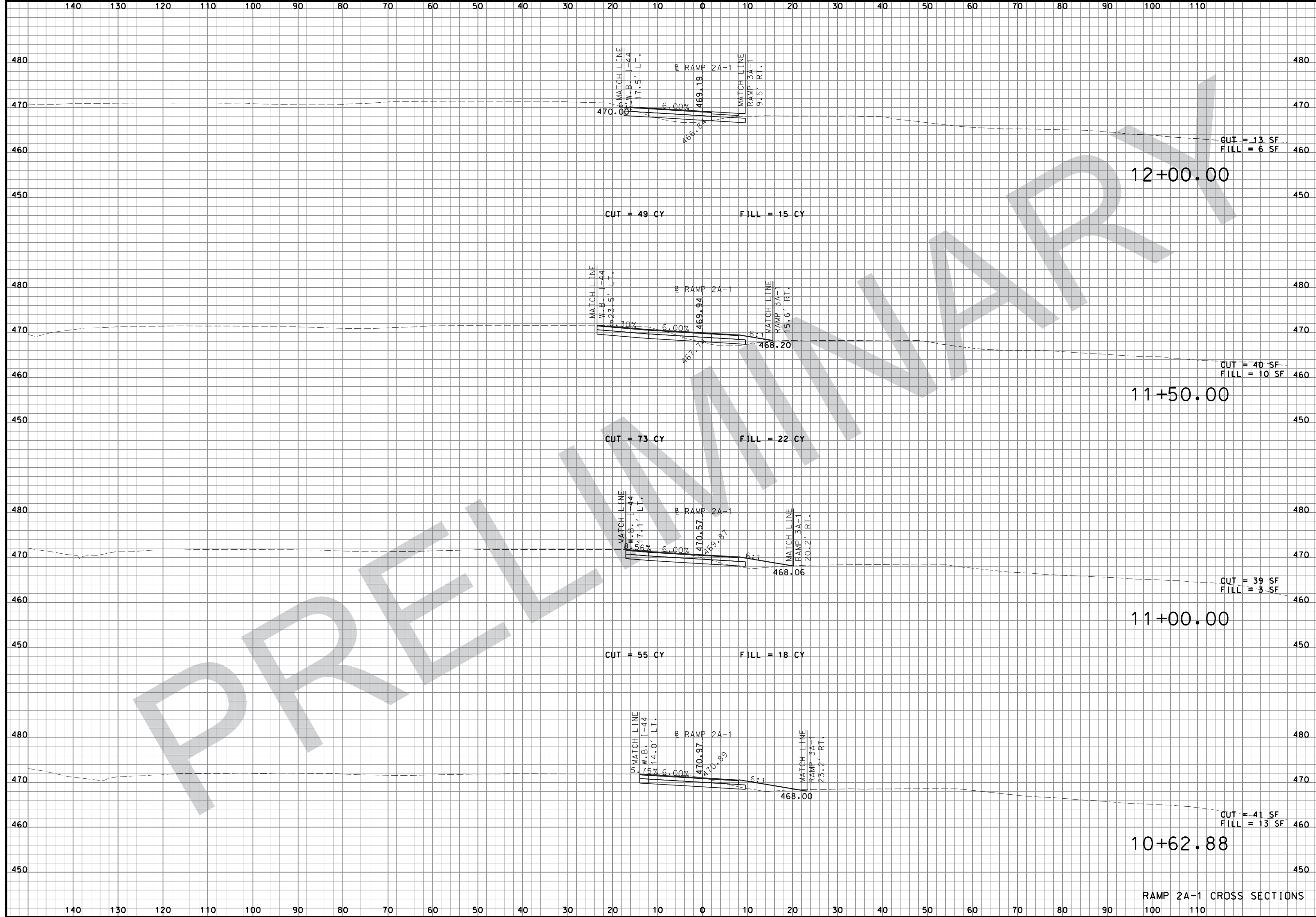

"THIS MEDIA SHOULD NOT BE CONSIDERED A CERTIFIED DOCUMENT."

DATE PREPARED
08-FEB-2018

ROUTE I-44 STATE MO

DISTRICT SL SHEET NO. XS54

COUNTY ST. LOUIS

JOB NO. J613029

CONTRACT ID.

PROJECT NO.

BRIDGE NO.

DATE	DESCRIPTION

MISSOURI HIGHWAYS AND TRANSPORTATION COMMISSION



105 WEST CAPITOL
JEFFERSON CITY, MO 65102
1-888-ASK-MODOT (1-888-275-6636)

JACOBS

JACOBS ENGINEERING GROUP
501 NORTH BROADWAY
ST. LOUIS, MISSOURI 63102-2121
PHONE: (314) 335-4000
CERTIFICATE OF AUTHORITY #00704

IF A SEAL IS PRESENT ON THIS SHEET IT HAS BEEN ELECTRONICALLY SEALED AND DATED:

RAMP 2A-1 CROSS SECTIONS

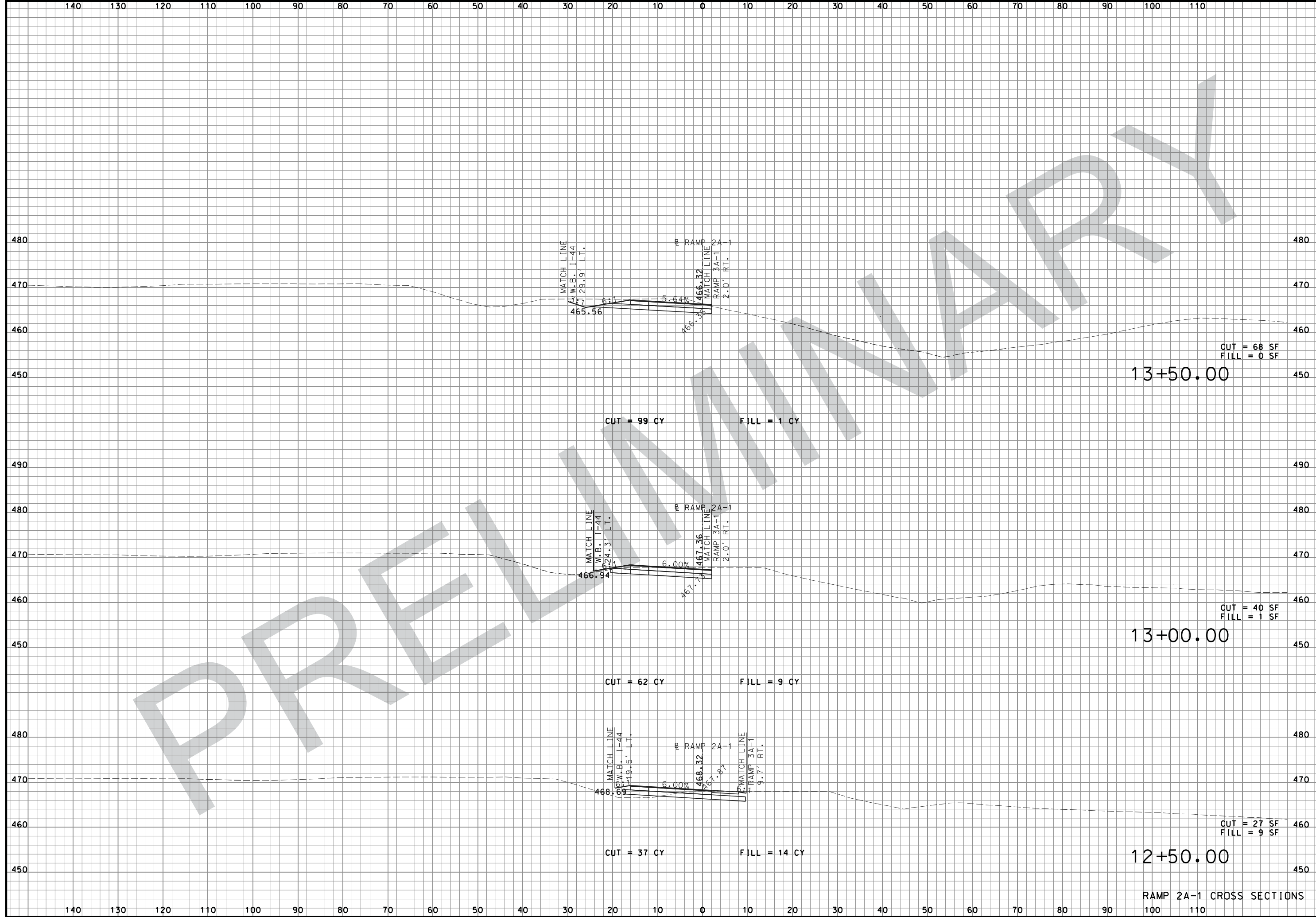

"THIS MEDIA SHOULD NOT BE CONSIDERED A CERTIFIED DOCUMENT."

DATE PREPARED 08-FEB-2018	
ROUTE I-44	STATE MO
DISTRICT SL	SHEET NO. XS55
COUNTY ST. LOUIS	
JOB NO. J613029	
CONTRACT ID.	
PROJECT NO.	
BRIDGE NO.	
DESCRIPTION	
DATE	

MISSOURI HIGHWAYS AND TRANSPORTATION COMMISSION

105 WEST CAPITOL
JEFFERSON CITY, MO 65102
1-888-ASK-MODOT (1-888-275-6636)

JACOBS
 JACOBS ENGINEERING GROUP
 501 NORTH BROADWAY
 ST. LOUIS, MISSOURI 63102-2121
 PHONE: (314) 335-4000
 CERTIFICATE OF AUTHORITY #00704

RAMP 2A-1 CROSS SECTIONS

IF A SEAL IS PRESENT ON THIS SHEET IT HAS BEEN ELECTRONICALLY SEALED AND DATED:

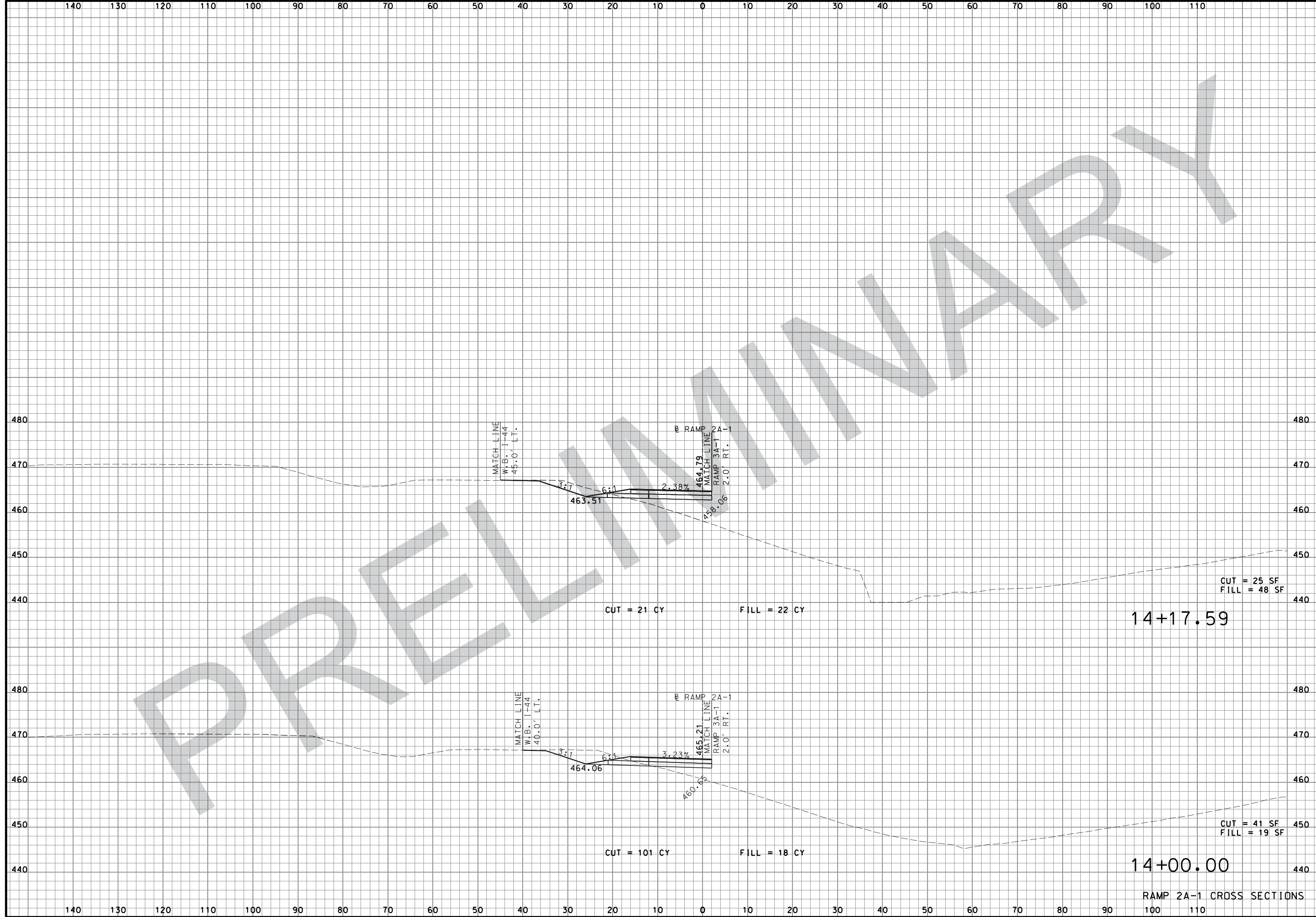

"THIS MEDIA SHOULD NOT BE CONSIDERED A CERTIFIED DOCUMENT."

DATE PREPARED
08-FEB-2018

ROUTE I-44	STATE MO
DISTRICT SL	SHEET NO. XS56

COUNTY
ST. LOUIS

JOB NO.
J613029

CONTRACT ID.

PROJECT NO.

BRIDGE NO.

DATE	DESCRIPTION

MISSOURI HIGHWAYS AND TRANSPORTATION COMMISSION



105 WEST CAPITOL
JEFFERSON CITY, MO 65102
1-888-ASK-MODOT (1-888-275-6636)

JACOBS

JACOBS ENGINEERING GROUP
501 NORTH BROADWAY
ST. LOUIS, MISSOURI 63102-2121
PHONE: (314) 335-4000
CERTIFICATE OF AUTHORITY #00704

IF A SEAL IS PRESENT ON THIS SHEET IT HAS BEEN ELECTRONICALLY SEALED AND DATED:

RAMP 2A-1 CROSS SECTIONS

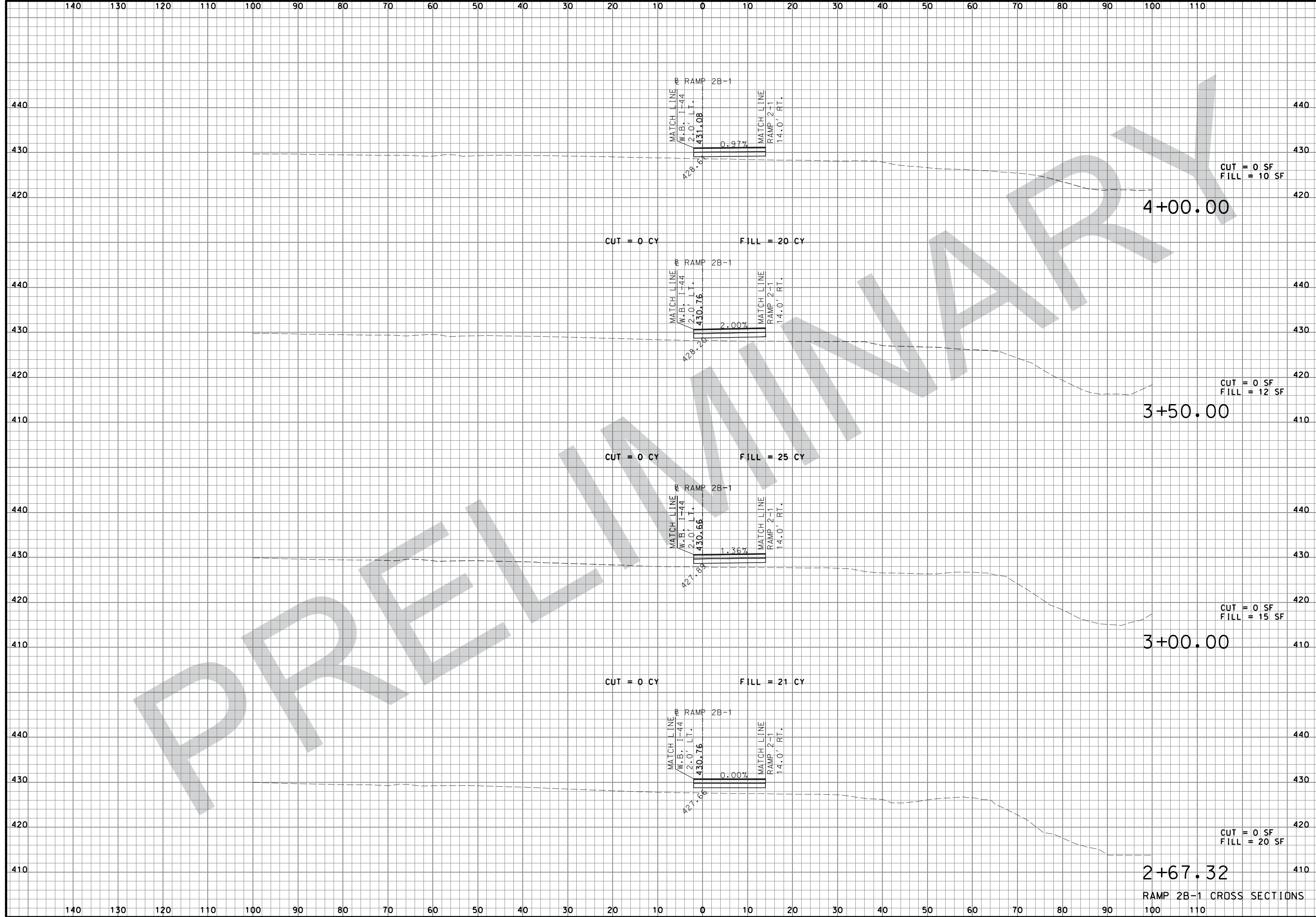

"THIS MEDIA SHOULD NOT BE CONSIDERED A CERTIFIED DOCUMENT."

DATE PREPARED 08-FEB-2018	
ROUTE I-44	STATE MO
DISTRICT SL	SHEET NO. XS57
COUNTY ST. LOUIS	
JOB NO. J613029	
CONTRACT ID.	
PROJECT NO.	
BRIDGE NO.	

DATE	DESCRIPTION

MISSOURI HIGHWAYS AND TRANSPORTATION COMMISSION

105 WEST CAPITOL
JEFFERSON CITY, MO 65102
1-888-ASK-MODOT (1-888-275-6636)

JACOBS ENGINEERING GROUP
501 NORTH BROADWAY
ST. LOUIS, MISSOURI 63102-2121
PHONE: (314) 335-4000
CERTIFICATE OF AUTHORITY #00704

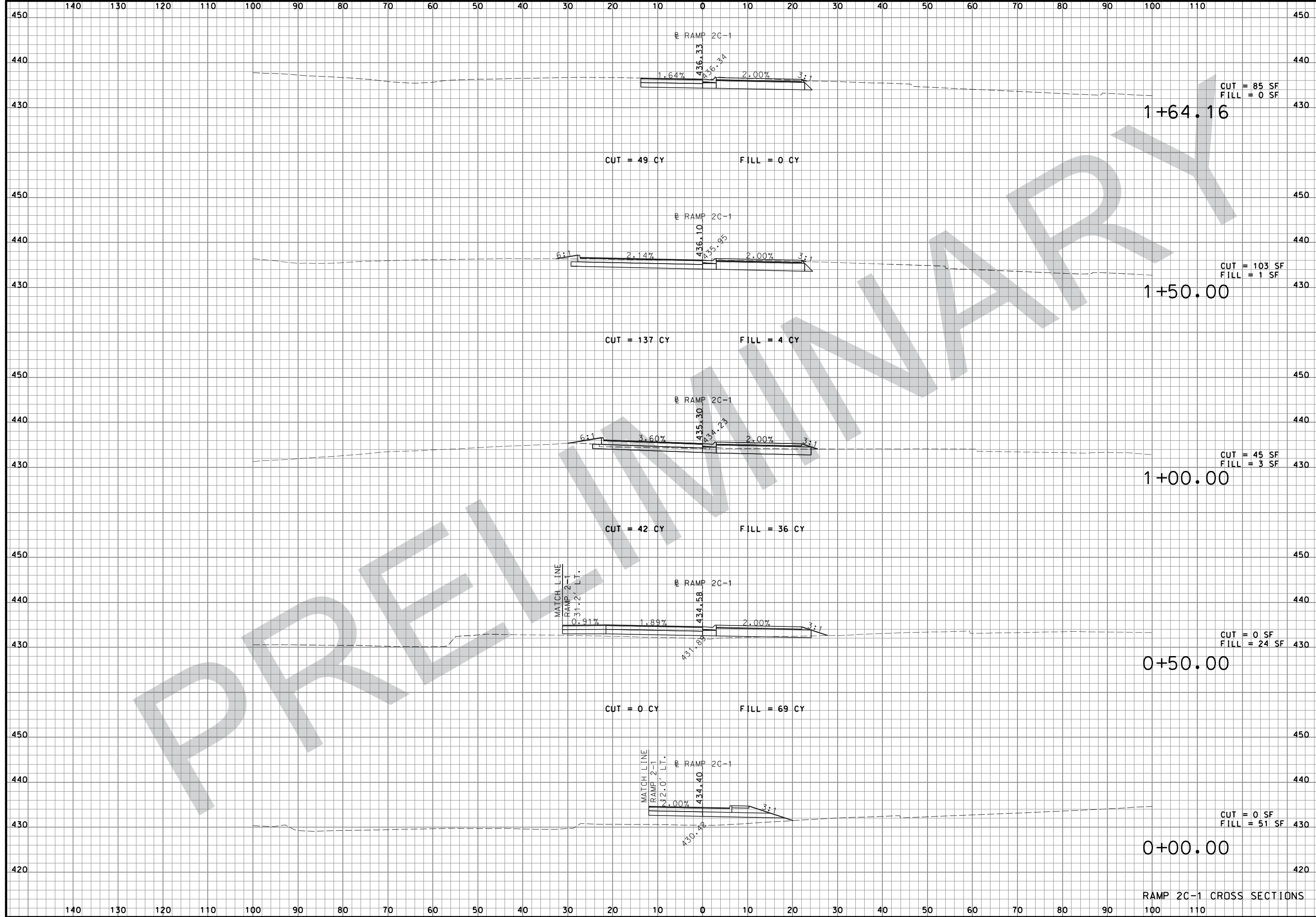

"THIS MEDIA SHOULD NOT BE CONSIDERED A CERTIFIED DOCUMENT."

DATE PREPARED
08-FEB-2018

ROUTE I-44	STATE MO
DISTRICT SL	SHEET NO. XS59

COUNTY
ST. LOUIS

JOB NO.
J613029

CONTRACT ID.

PROJECT NO.

BRIDGE NO.

DATE	DESCRIPTION

MISSOURI HIGHWAYS AND TRANSPORTATION COMMISSION



105 WEST CAPITOL
JEFFERSON CITY, MO 65102
1-888-ASK-MODOT (1-888-275-6636)

JACOBS

JACOBS ENGINEERING GROUP
501 NORTH BROADWAY
ST. LOUIS, MISSOURI 63102-2121
PHONE: (314) 335-4000
CERTIFICATE OF AUTHORITY #00704

IF A SEAL IS PRESENT ON THIS SHEET IT HAS BEEN ELECTRONICALLY SEALED AND DATED:

RAMP 2C-1 CROSS SECTIONS

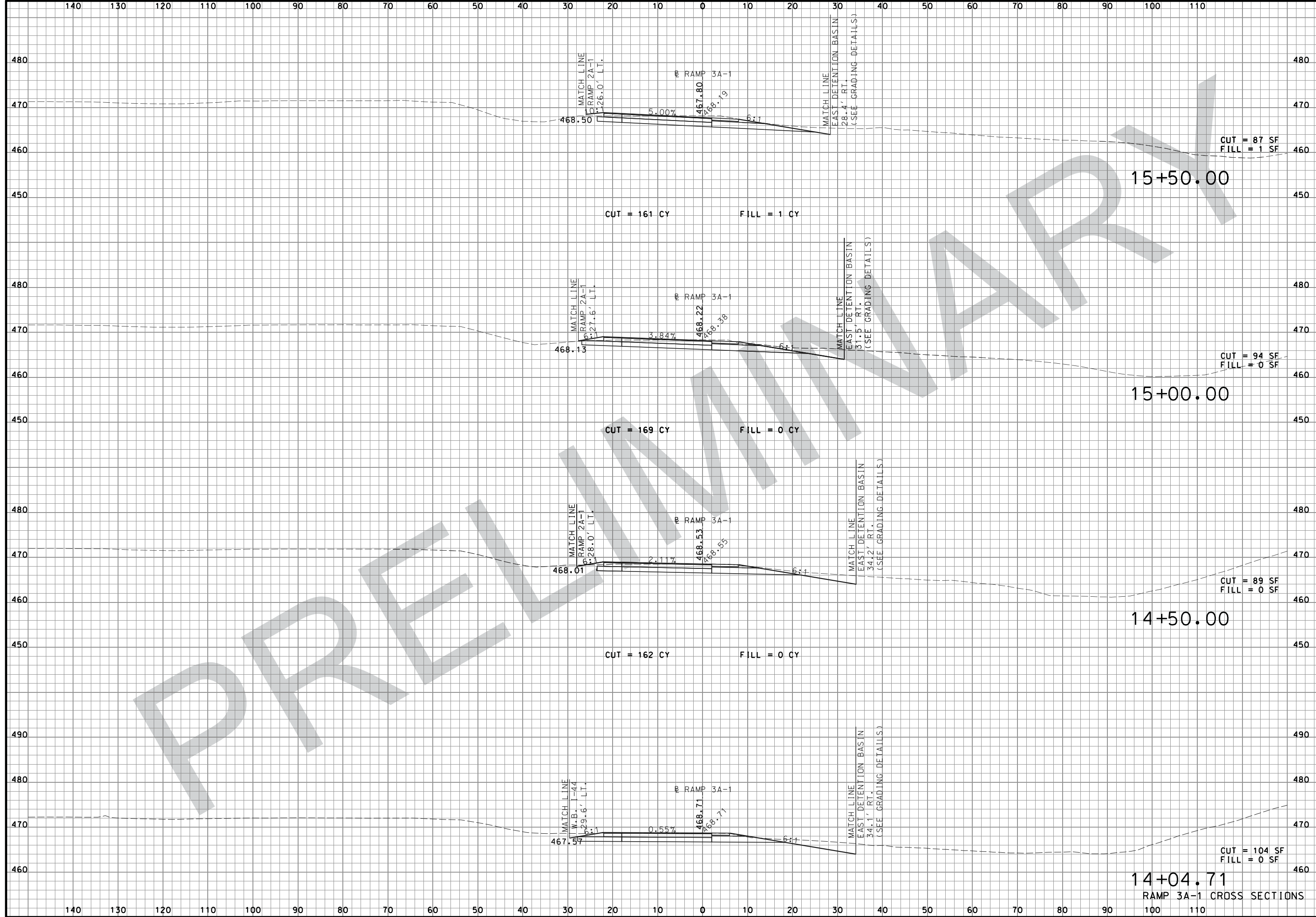

"THIS MEDIA SHOULD NOT BE CONSIDERED A CERTIFIED DOCUMENT."

DATE PREPARED: 08-FEB-2018

ROUTE: I-44	STATE: MO
DISTRICT: SL	SHEET NO.: XS60

COUNTY: ST. LOUIS
 JOB NO.: J613029
 CONTRACT ID.

PROJECT NO.
 BRIDGE NO.

DATE	DESCRIPTION

MISSOURI HIGHWAYS AND TRANSPORTATION COMMISSION

MODOT
 105 WEST CAPITOL
 JEFFERSON CITY, MO 65102
 1-888-ASK-MODOT (1-888-275-6636)

JACOBS
 JACOBS ENGINEERING GROUP
 501 NORTH BROADWAY
 ST. LOUIS, MISSOURI 63102-2121
 PHONE: (314) 335-4000
 CERTIFICATE OF AUTHORITY #00704

IF A SEAL IS PRESENT ON THIS SHEET IT HAS BEEN ELECTRONICALLY SEALED AND DATED:

RAMP 3A-1 CROSS SECTIONS

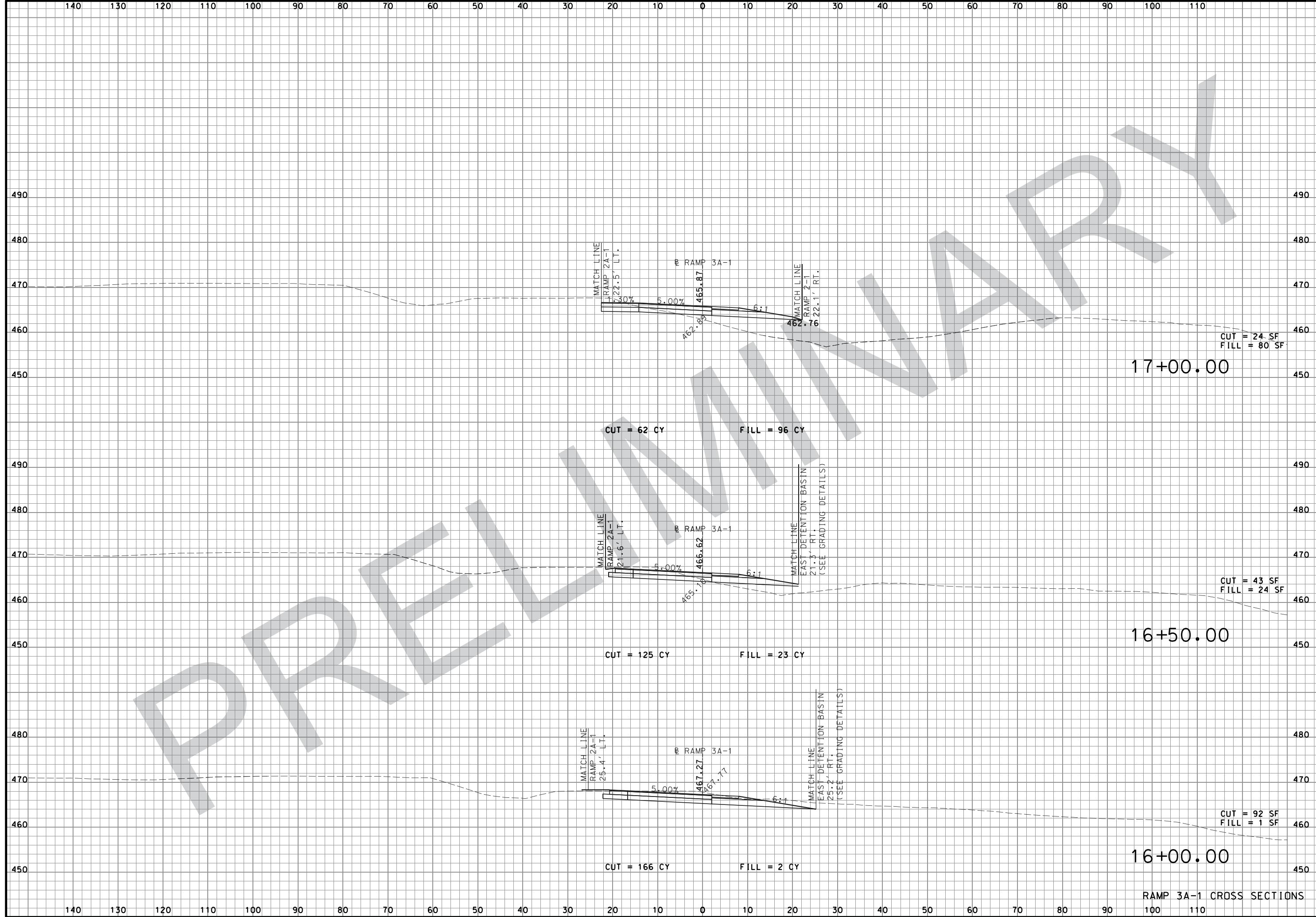

"THIS MEDIA SHOULD NOT BE CONSIDERED A CERTIFIED DOCUMENT."

DATE PREPARED: 08-FEB-2018
 ROUTE: I-44 STATE: MO
 DISTRICT: SL SHEET NO.: XS61
 COUNTY: ST. LOUIS
 JOB NO.: J613029
 CONTRACT ID.:

PROJECT NO.:
 BRIDGE NO.:

DATE	DESCRIPTION

MISSOURI HIGHWAYS AND TRANSPORTATION COMMISSION

MODOT

105 WEST CAPITOL
 JEFFERSON CITY, MO 65102
 1-888-ASK-MODDOT (1-888-275-6636)

JACOBS

JACOBS ENGINEERING GROUP
 501 NORTH BROADWAY
 ST. LOUIS, MISSOURI 63102-2121
 PHONE: (314) 335-4000
 CERTIFICATE OF AUTHORITY #00704

IF A SEAL IS PRESENT ON THIS SHEET IT HAS BEEN ELECTRONICALLY SEALED AND DATED:

RAMP 3A-1 CROSS SECTIONS

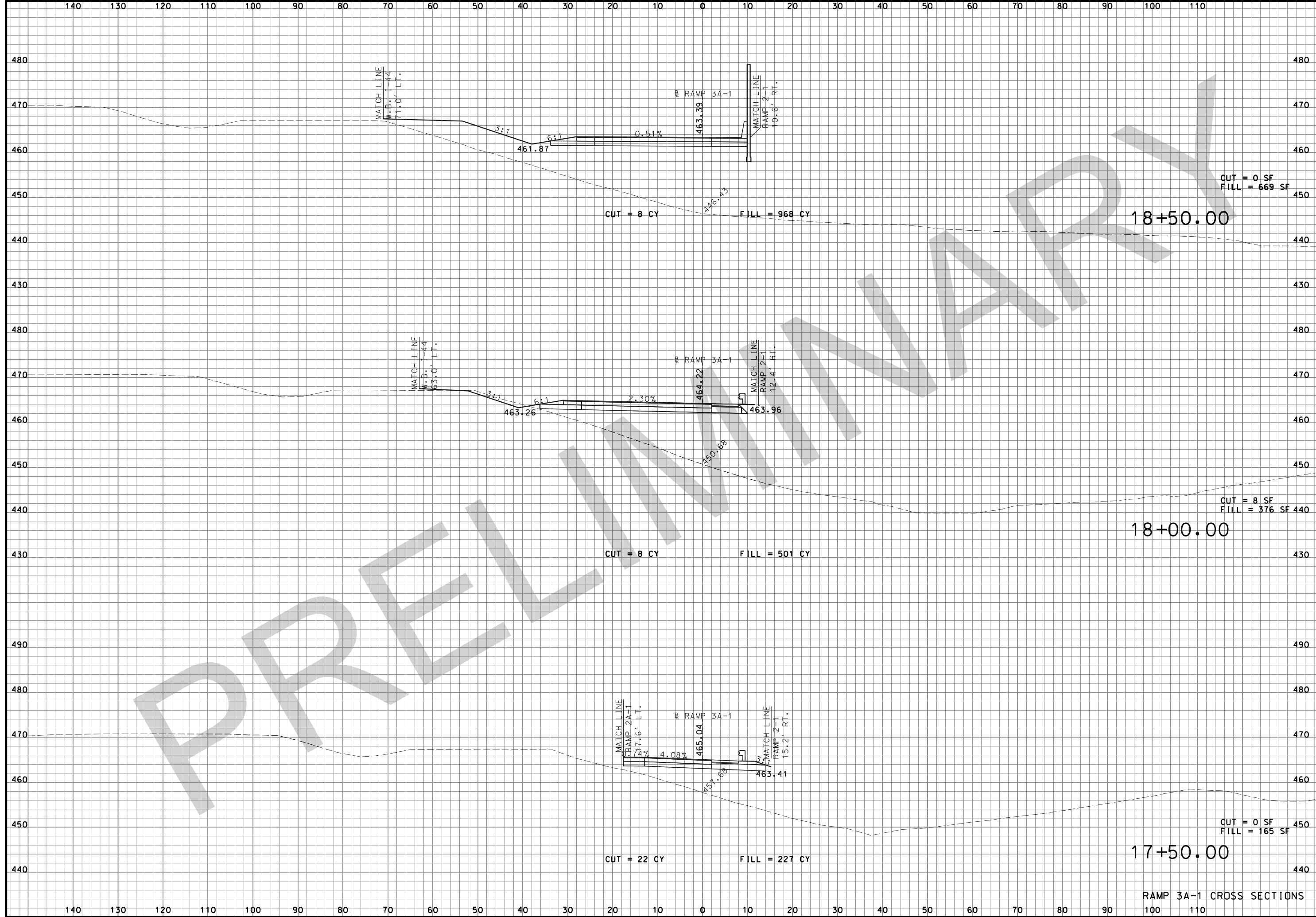

"THIS MEDIA SHOULD NOT BE CONSIDERED A CERTIFIED DOCUMENT."

DATE PREPARED 08-FEB-2018	
ROUTE I-44	STATE MO
DISTRICT SL	SHEET NO. XS62
COUNTY ST. LOUIS	
JOB NO. J613029	
CONTRACT ID.	
PROJECT NO.	
BRIDGE NO.	

DATE	DESCRIPTION

MISSOURI HIGHWAYS AND TRANSPORTATION COMMISSION

105 WEST CAPITOL
JEFFERSON CITY, MO 65102
1-888-ASK-MODOT (1-888-275-6636)

JACOBS ENGINEERING GROUP
501 NORTH BROADWAY
ST. LOUIS, MISSOURI 63102-2121
PHONE: (314) 335-4000
CERTIFICATE OF AUTHORITY #00704

RAMP 3A-1 CROSS SECTIONS

IF A SEAL IS PRESENT ON THIS SHEET IT HAS BEEN ELECTRONICALLY SEALED AND DATED:

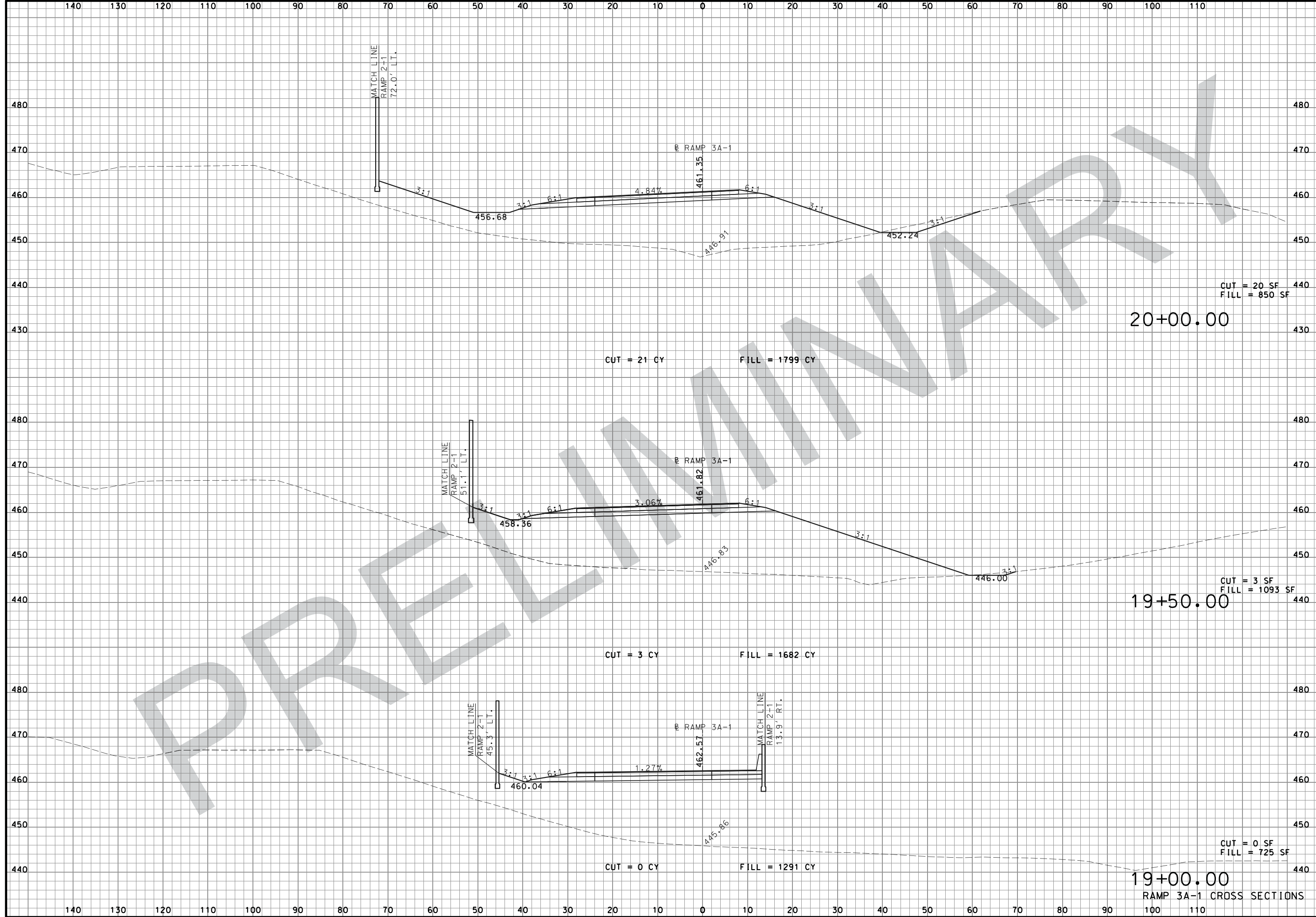

"THIS MEDIA SHOULD NOT BE CONSIDERED A CERTIFIED DOCUMENT."

DATE PREPARED 08-FEB-2018	
ROUTE I-44	STATE MO
DISTRICT SL	SHEET NO. XS63
COUNTY ST. LOUIS	
JOB NO. J613029	
CONTRACT ID.	
PROJECT NO.	
BRIDGE NO.	

DATE	DESCRIPTION

MISSOURI HIGHWAYS AND TRANSPORTATION COMMISSION

105 WEST CAPITOL
JEFFERSON CITY, MO 65102
1-888-ASK-MODOT (1-888-275-6636)

JACOBS ENGINEERING GROUP
501 NORTH BROADWAY
ST. LOUIS, MISSOURI 63102-2121
PHONE: (314) 335-4000
CERTIFICATE OF AUTHORITY #00704

IF A SEAL IS PRESENT ON THIS SHEET IT HAS BEEN ELECTRONICALLY SEALED AND DATED:

RAMP 3A-1 CROSS SECTIONS

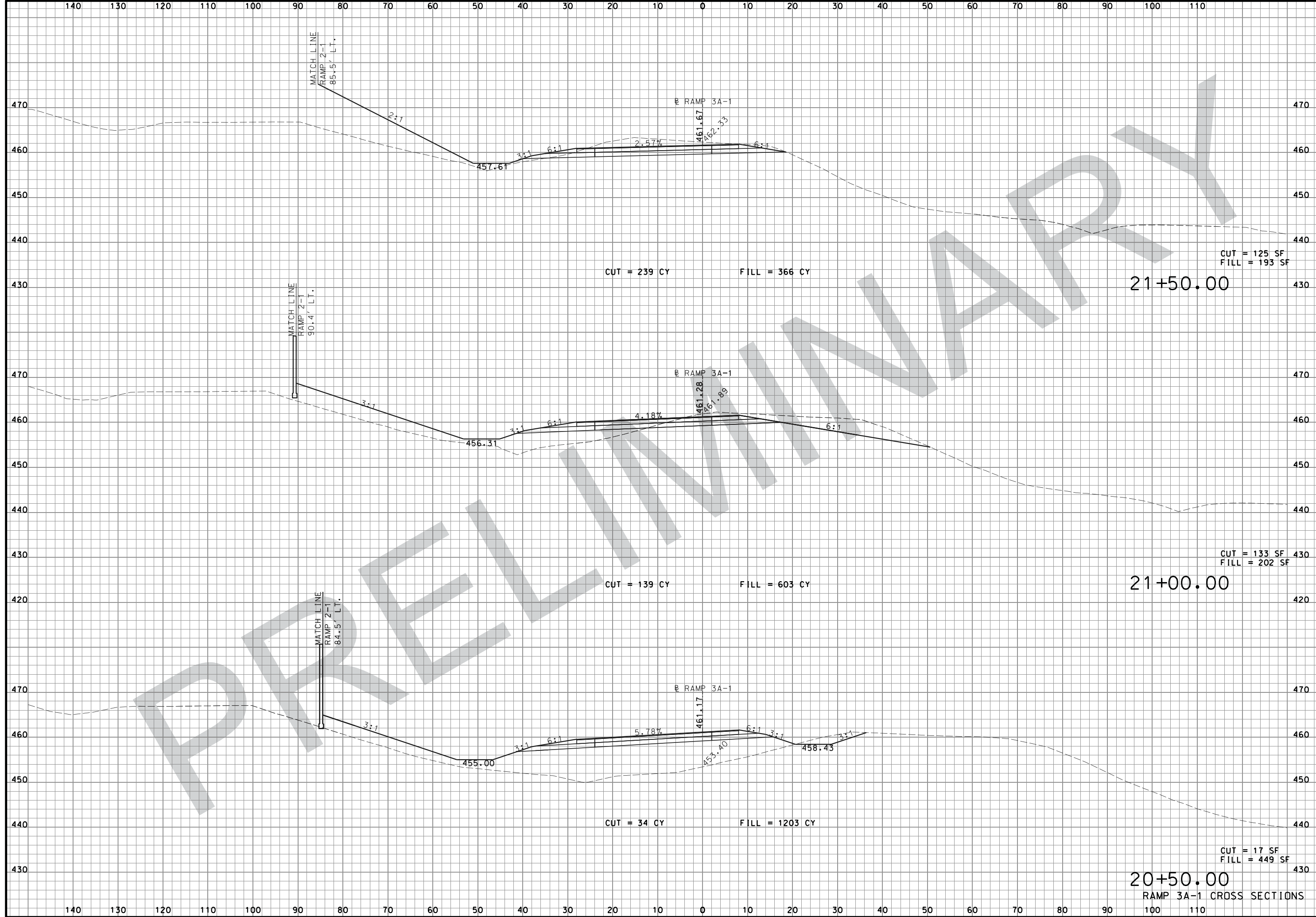

"THIS MEDIA SHOULD NOT BE CONSIDERED A CERTIFIED DOCUMENT."

DATE PREPARED
08-FEB-2018
ROUTE I-44 STATE MO
DISTRICT SL SHEET NO. XS64
COUNTY ST. LOUIS
JOB NO. J613029
CONTRACT ID.

PROJECT NO.
BRIDGE NO.

DATE	DESCRIPTION

MISSOURI HIGHWAYS AND TRANSPORTATION COMMISSION

 105 WEST CAPITOL
 JEFFERSON CITY, MO 65102
 1-888-ASK-MODOT (1-888-275-6636)

JACOBS
 JACOBS ENGINEERING GROUP
 501 NORTH BROADWAY
 ST. LOUIS, MISSOURI 63102-2121
 PHONE: (314) 335-4000
 CERTIFICATE OF AUTHORITY #00704

20+50.00
RAMP 3A-1 CROSS SECTIONS
CUT = 17 SF
FILL = 449 SF

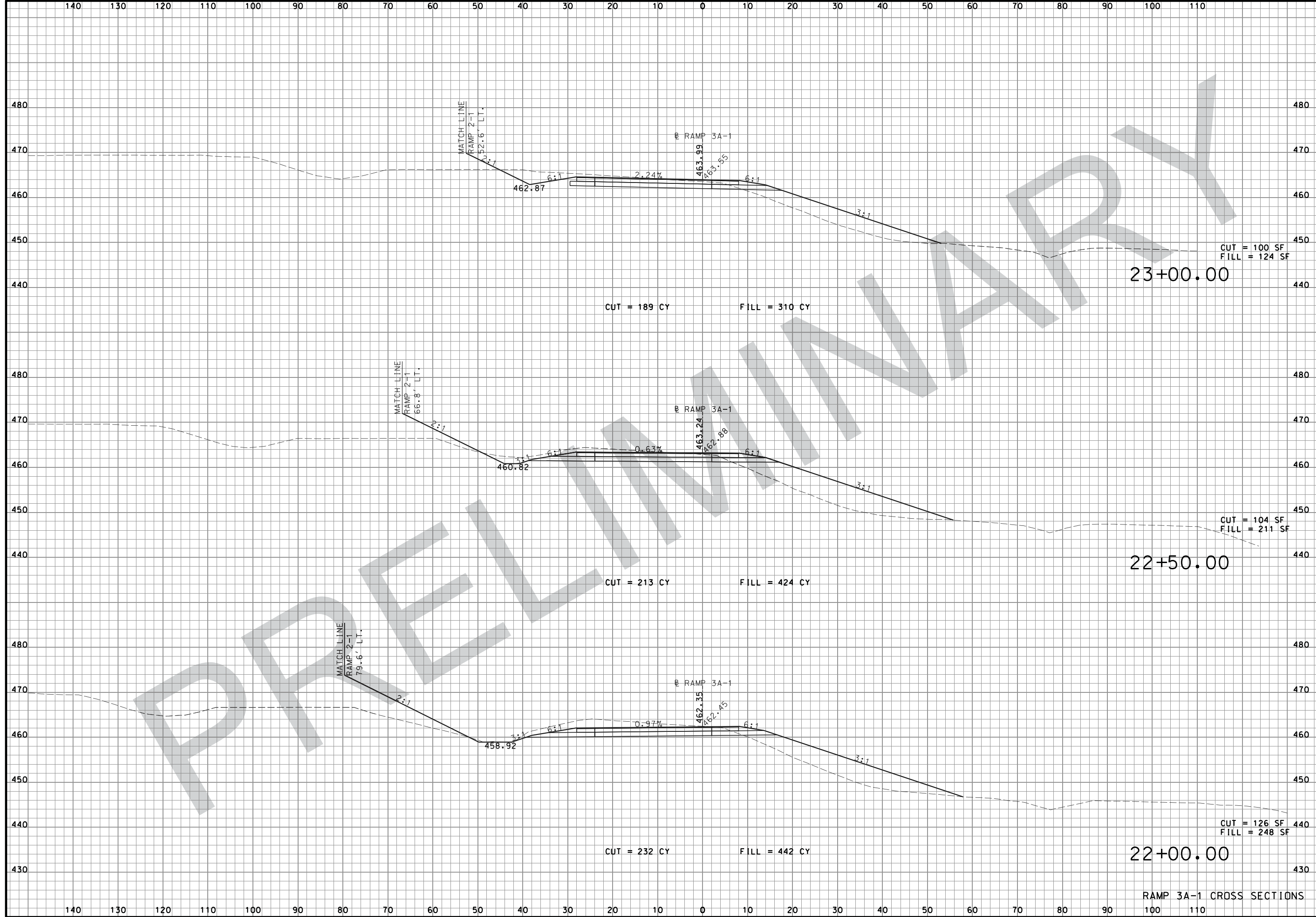
IF A SEAL IS PRESENT ON THIS SHEET IT HAS BEEN ELECTRONICALLY SEALED AND DATED:



"THIS MEDIA SHOULD NOT BE CONSIDERED A CERTIFIED DOCUMENT."

DATE PREPARED 08-FEB-2018	
ROUTE I-44	STATE MO
DISTRICT SL	SHEET NO. XS65
COUNTY ST. LOUIS	
JOB NO. J613029	
CONTRACT ID.	
PROJECT NO.	
BRIDGE NO.	

DATE	DESCRIPTION

MISSOURI HIGHWAYS AND TRANSPORTATION COMMISSION

105 WEST CAPITOL
JEFFERSON CITY, MO 65102
1-888-ASK-MODOT (1-888-275-6636)

JACOBS ENGINEERING GROUP
501 NORTH BROADWAY
ST. LOUIS, MISSOURI 63102-2121
PHONE: (314) 335-4000
CERTIFICATE OF AUTHORITY #00704

RAMP 3A-1 CROSS SECTIONS

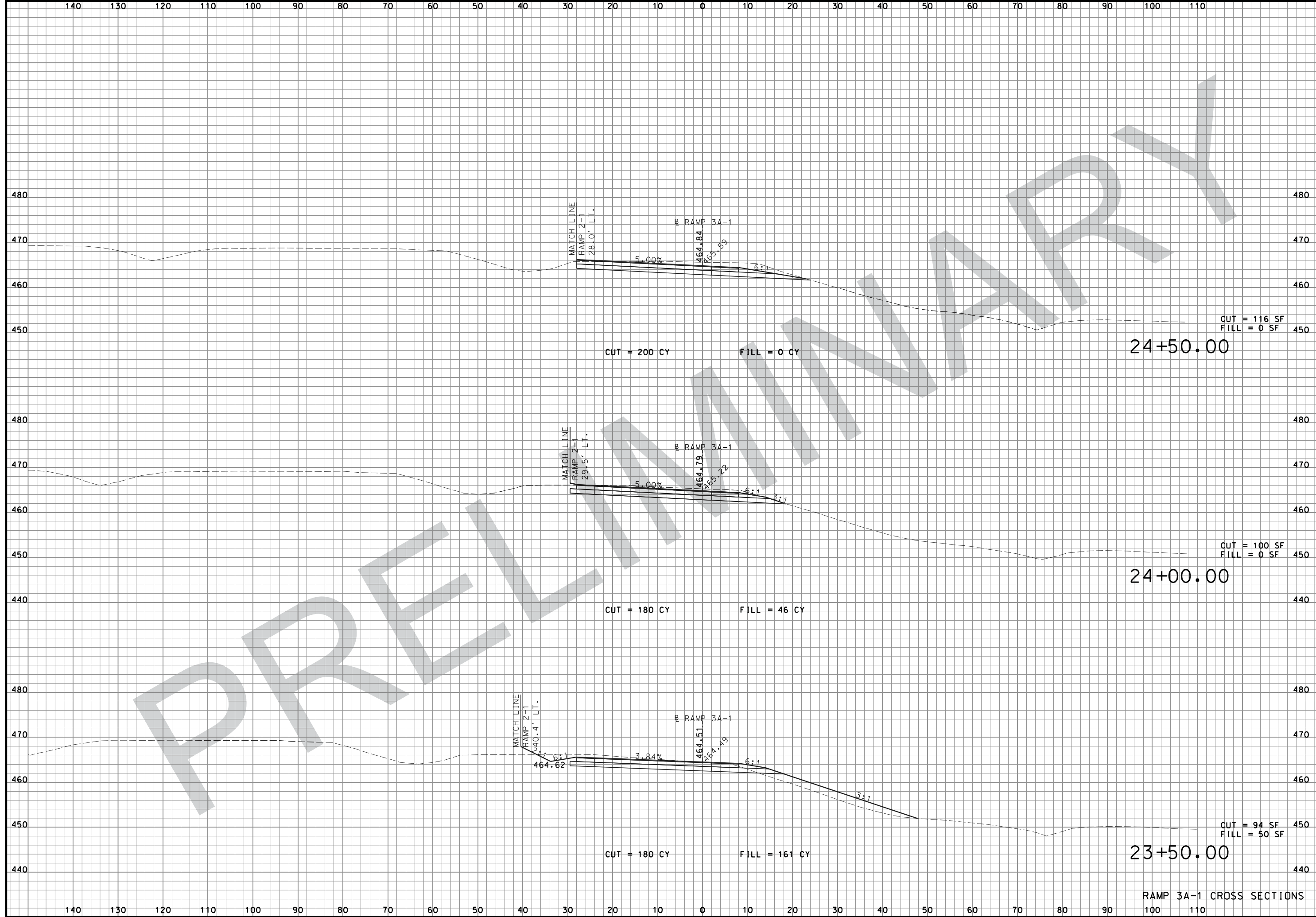

"THIS MEDIA SHOULD NOT BE CONSIDERED A CERTIFIED DOCUMENT."

DATE PREPARED
08-FEB-2018

ROUTE	STATE
I-44	MO
DISTRICT	SHEET NO.
SL	XS66
COUNTY	
ST. LOUIS	
JOB NO.	
J613029	
CONTRACT ID.	

PROJECT NO.
BRIDGE NO.

DESCRIPTION	DATE

MISSOURI HIGHWAYS AND TRANSPORTATION COMMISSION



105 WEST CAPITOL
JEFFERSON CITY, MO 65102
1-888-ASK-MODOT (1-888-275-6636)

JACOBS

JACOBS ENGINEERING GROUP
501 NORTH BROADWAY
ST. LOUIS, MISSOURI 63102-2121
PHONE: (314) 335-4000
CERTIFICATE OF AUTHORITY #00704

IF A SEAL IS PRESENT ON THIS SHEET IT HAS BEEN ELECTRONICALLY SEALED AND DATED:

RAMP 3A-1 CROSS SECTIONS

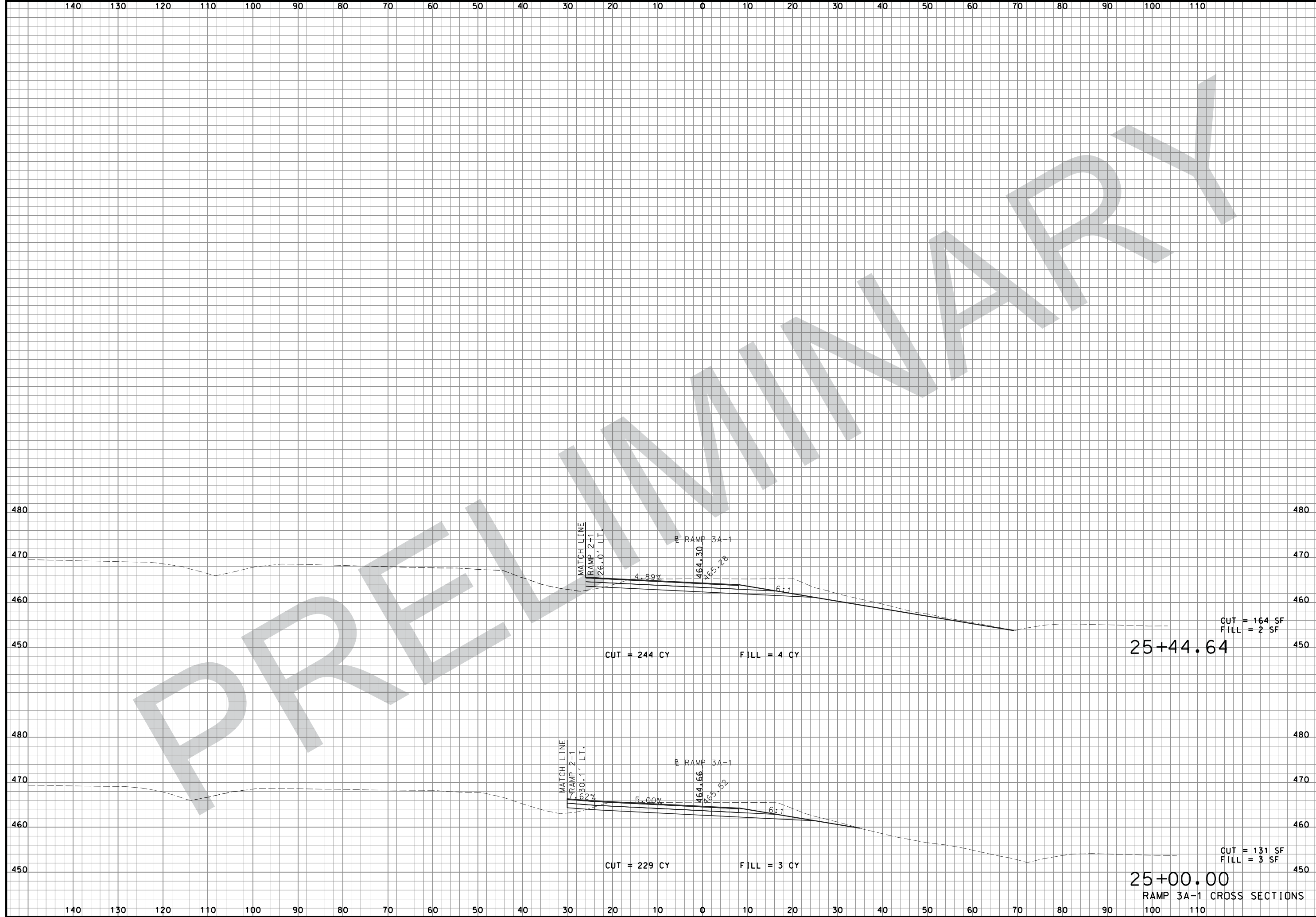

"THIS MEDIA SHOULD NOT BE CONSIDERED A CERTIFIED DOCUMENT."

DATE PREPARED
08-FEB-2018

ROUTE I-44	STATE MO
DISTRICT SL	SHEET NO. XS67
COUNTY ST. LOUIS	
JOB NO. J613029	
CONTRACT ID.	

PROJECT NO.
 BRIDGE NO.

DATE	DESCRIPTION

MISSOURI HIGHWAYS AND TRANSPORTATION COMMISSION



105 WEST CAPITOL
 JEFFERSON CITY, MO 65102
 1-888-ASK-MODOT (1-888-275-6636)

JACOBS

JACOBS ENGINEERING GROUP
 501 NORTH BROADWAY
 ST. LOUIS, MISSOURI 63102-2121
 PHONE: (314) 335-4000
 CERTIFICATE OF AUTHORITY #00704

IF A SEAL IS PRESENT ON THIS SHEET IT HAS BEEN ELECTRONICALLY SEALED AND DATED:

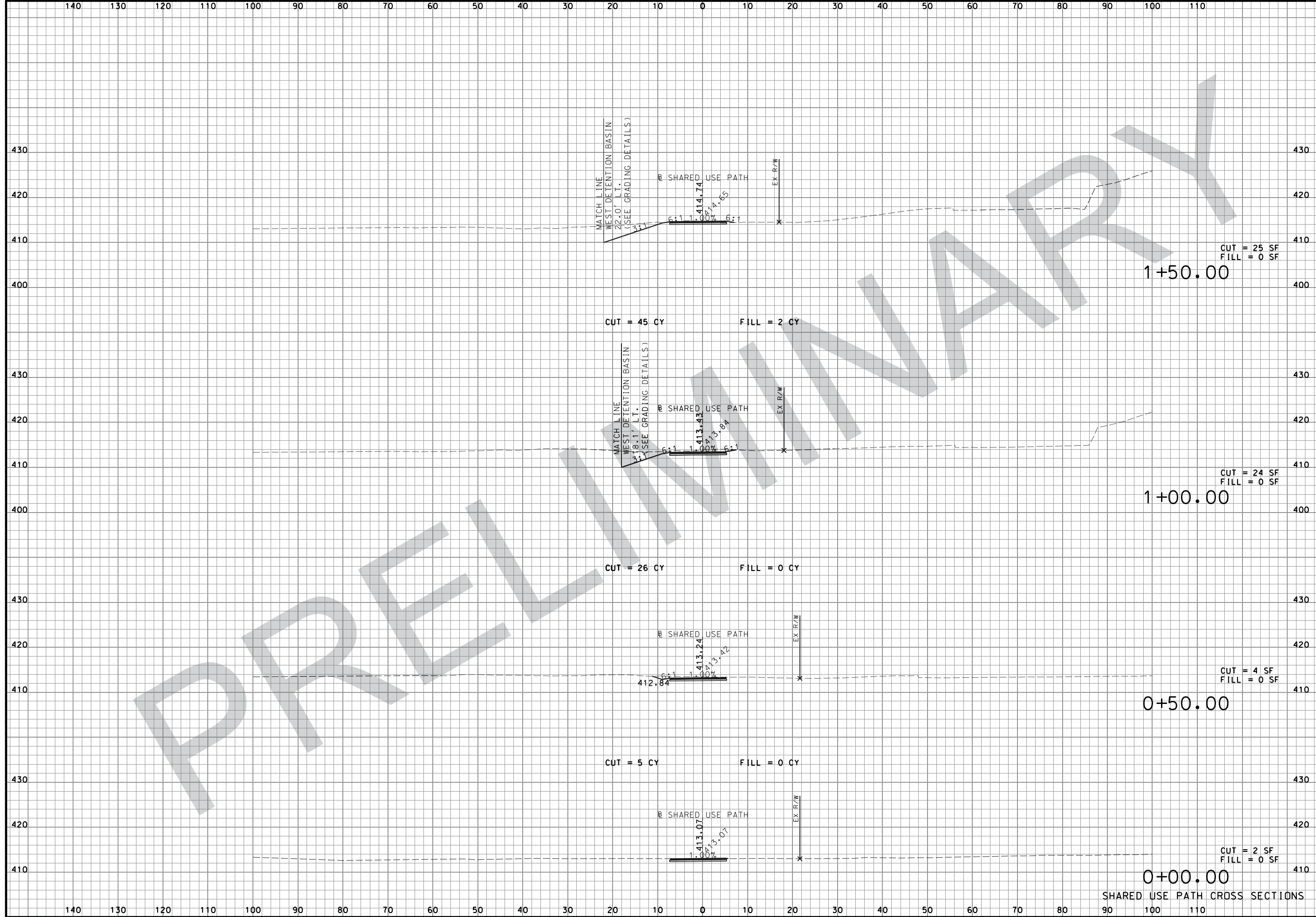

SHARED USE PATH CROSS SECTIONS

"THIS MEDIA SHOULD NOT BE CONSIDERED A CERTIFIED DOCUMENT."

DATE PREPARED 08-FEB-2018	
ROUTE I-44	STATE MO
DISTRICT SL	SHEET NO. XS68
COUNTY ST. LOUIS	
JOB NO. J613029	
CONTRACT ID.	

PROJECT NO.
BRIDGE NO.

DATE	DESCRIPTION

MISSOURI HIGHWAYS AND TRANSPORTATION COMMISSION

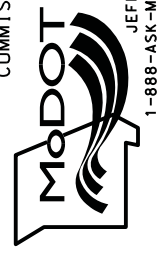

105 WEST CAPITOL
JEFFERSON CITY, MO 65102
1-888-ASK-MODOT (1-888-275-6636)

JACOBS

JACOBS ENGINEERING GROUP
501 NORTH BROADWAY
ST. LOUIS, MISSOURI 63102-2121
PHONE: (314) 335-4000
CERTIFICATE OF AUTHORITY #00704

IF A SEAL IS PRESENT ON THIS SHEET IT HAS BEEN ELECTRONICALLY SEALED AND DATED:

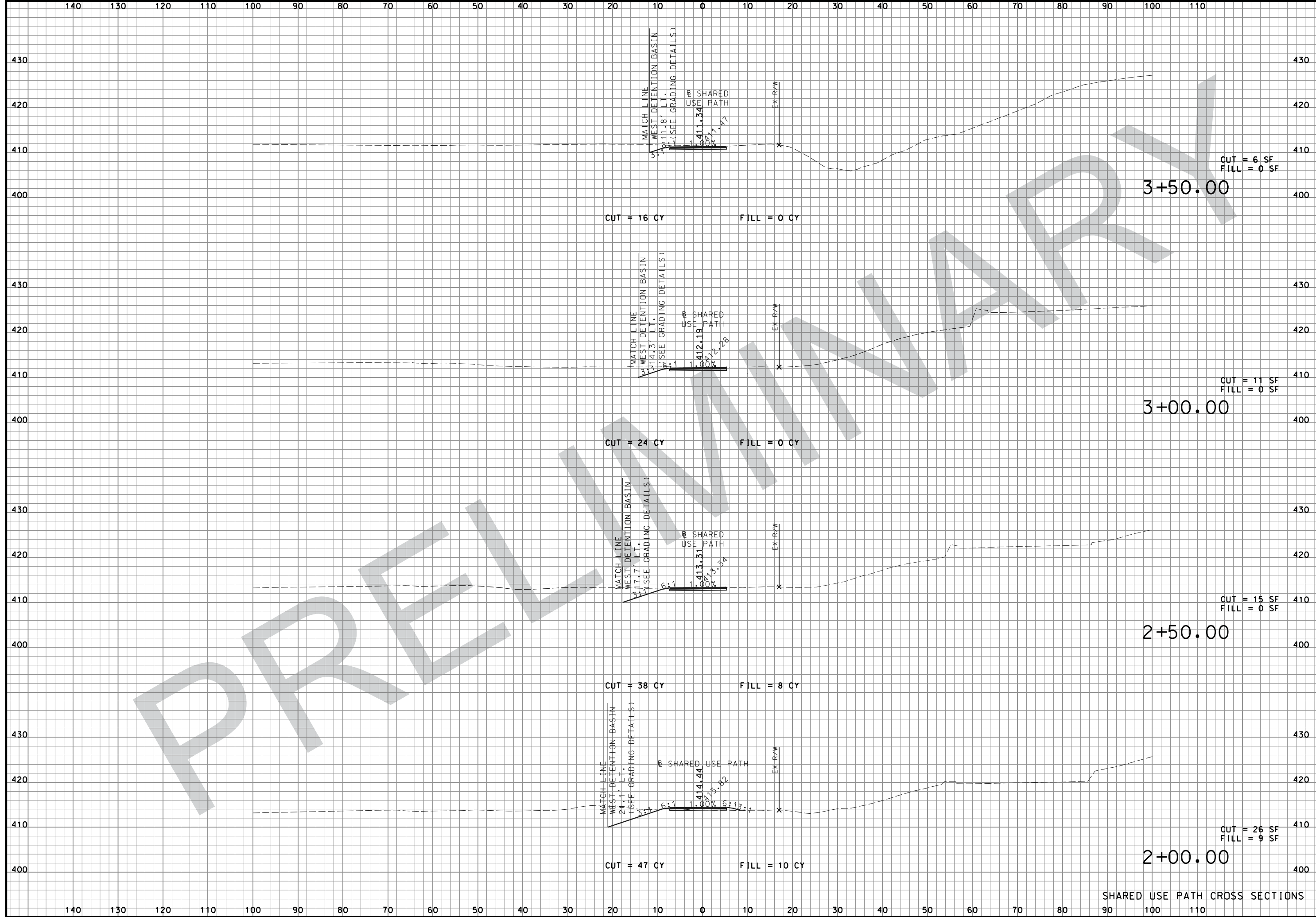

SHARED USE PATH CROSS SECTIONS

"THIS MEDIA SHOULD NOT BE CONSIDERED A CERTIFIED DOCUMENT."

DATE PREPARED 08-FEB-2018	
ROUTE I-44	STATE MO
DISTRICT SL	SHEET NO. XS69
COUNTY ST. LOUIS	
JOB NO. J613029	
CONTRACT ID.	
PROJECT NO.	
BRIDGE NO.	

DATE	DESCRIPTION

MISSOURI HIGHWAYS AND TRANSPORTATION COMMISSION

105 WEST CAPITOL
JEFFERSON CITY, MO 65102
1-888-ASK-MODOT (1-888-275-6636)

JACOBS ENGINEERING GROUP
501 NORTH BROADWAY
ST. LOUIS, MISSOURI 63102-2121
PHONE: (314) 335-4000
CERTIFICATE OF AUTHORITY #00704

IF A SEAL IS PRESENT ON THIS SHEET IT HAS BEEN ELECTRONICALLY SEALED AND DATED:

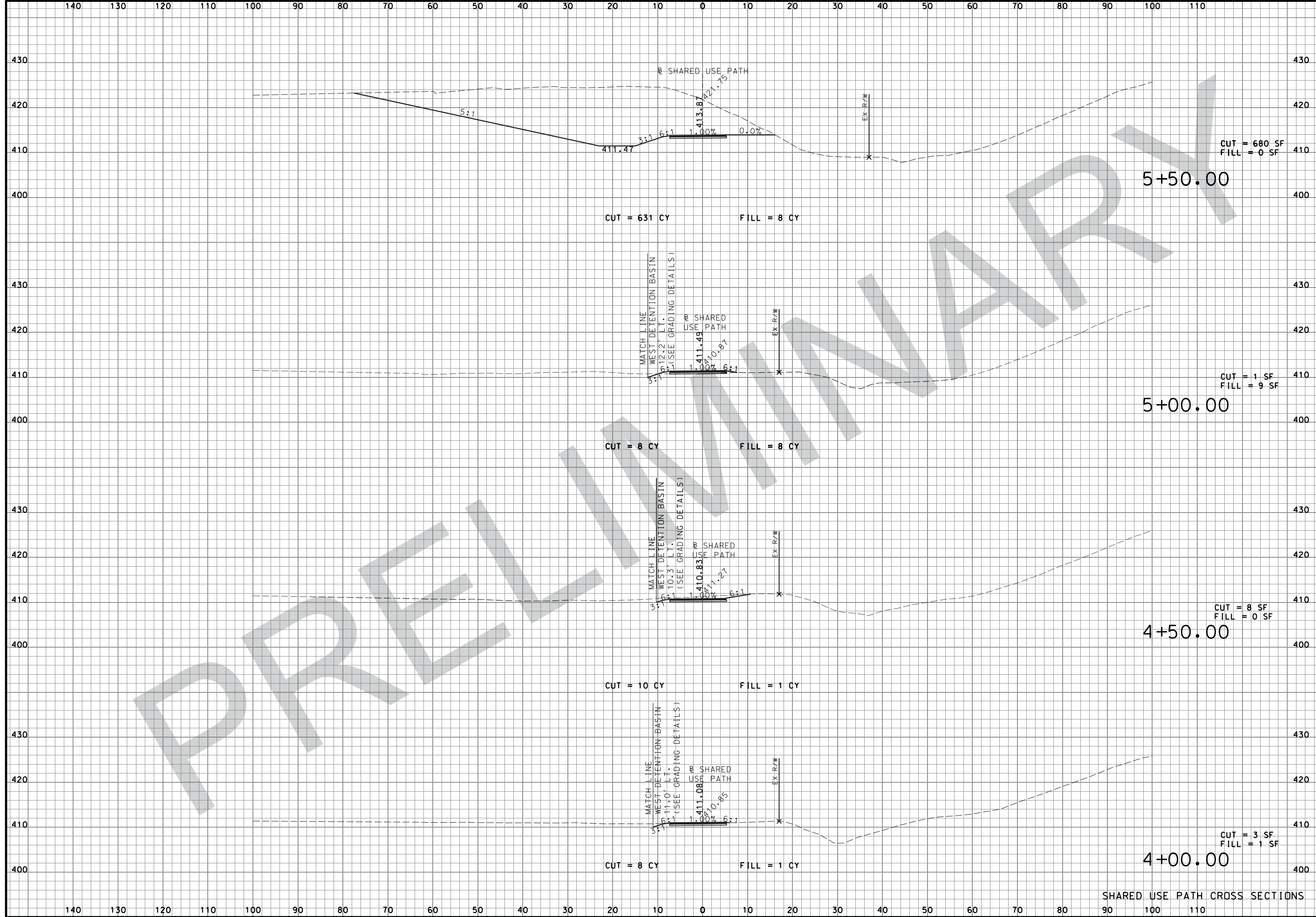

SHARED USE PATH CROSS SECTIONS

"THIS MEDIA SHOULD NOT BE CONSIDERED A CERTIFIED DOCUMENT."

DATE PREPARED
08-FEB-2018
ROUTE I-44 STATE MO
DISTRICT SL SHEET NO. XS70
COUNTY ST. LOUIS
JOB NO. J613029
CONTRACT ID.

PROJECT NO.
BRIDGE NO.

DATE	DESCRIPTION

MISSOURI HIGHWAYS AND TRANSPORTATION COMMISSION

 105 WEST CAPITOL
 JEFFERSON CITY, MO 65102
 1-888-ASK-MODOT (1-888-275-6636)

JACOBS
 JACOBS ENGINEERING GROUP
 501 NORTH BROADWAY
 ST. LOUIS, MISSOURI 63102-2121
 PHONE: (314) 335-4000
 CERTIFICATE OF AUTHORITY #00704

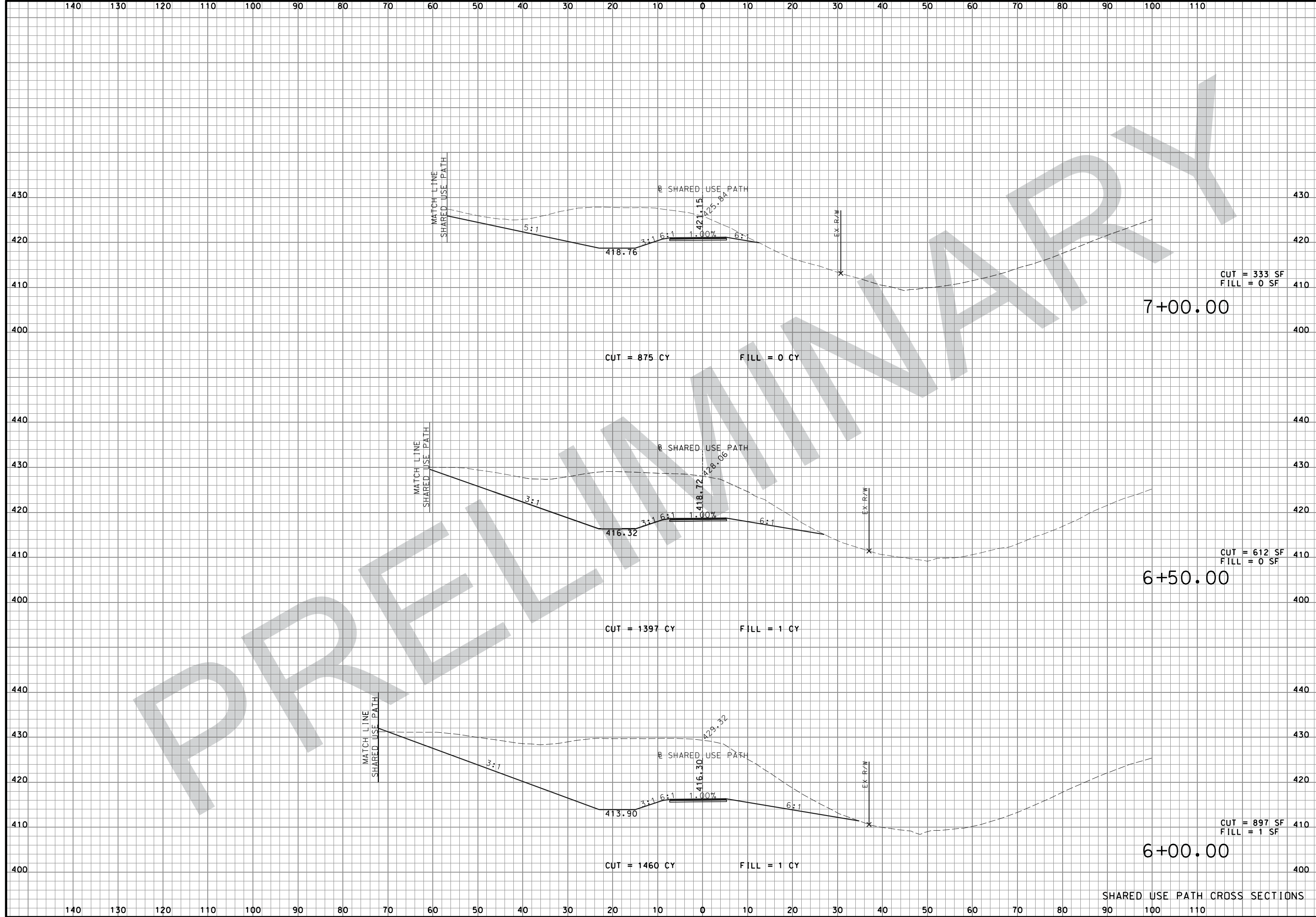
IF A SEAL IS PRESENT ON THIS SHEET IT HAS BEEN ELECTRONICALLY SEALED AND DATED:



"THIS MEDIA SHOULD NOT BE CONSIDERED A CERTIFIED DOCUMENT."

DATE PREPARED
08-FEB-2018

ROUTE STATE
I-44 MO

DISTRICT SHEET NO.
SL XS71

COUNTY
ST. LOUIS

JOB NO.
J613029

CONTRACT ID.

PROJECT NO.

BRIDGE NO.

DATE	DESCRIPTION

MISSOURI HIGHWAYS AND TRANSPORTATION COMMISSION



105 WEST CAPITOL
JEFFERSON CITY, MO 65102
1-888-ASK-MODOT (1-888-275-6636)

JACOBS

JACOBS ENGINEERING GROUP
501 NORTH BROADWAY
ST. LOUIS, MISSOURI 63102-2121
PHONE: (314) 335-4000
CERTIFICATE OF AUTHORITY #00704

IF A SEAL IS PRESENT ON THIS SHEET IT HAS BEEN ELECTRONICALLY SEALED AND DATED:

SHARED USE PATH CROSS SECTIONS

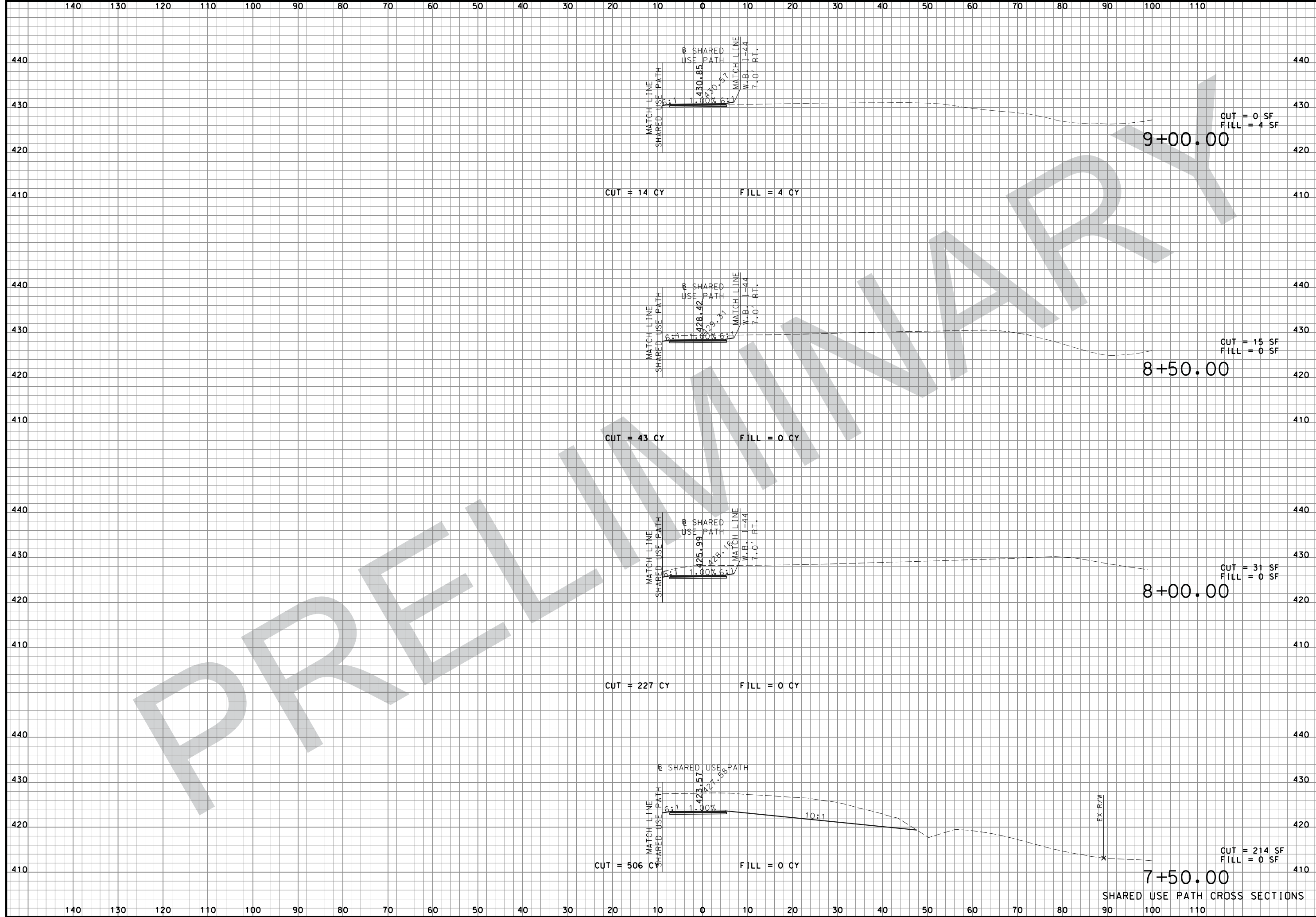

"THIS MEDIA SHOULD NOT BE CONSIDERED A CERTIFIED DOCUMENT."

DATE PREPARED 08-FEB-2018	
ROUTE I-44	STATE MO
DISTRICT SL	SHEET NO. XS72
COUNTY ST. LOUIS	
JOB NO. J613029	
CONTRACT ID.	
PROJECT NO.	
BRIDGE NO.	

DATE	DESCRIPTION

MISSOURI HIGHWAYS AND TRANSPORTATION COMMISSION

105 WEST CAPITOL
JEFFERSON CITY, MO 65102
1-888-ASK-MODOT (1-888-275-6636)

JACOBS ENGINEERING GROUP
501 NORTH BROADWAY
ST. LOUIS, MISSOURI 63102-2121
PHONE: (314) 335-4000
CERTIFICATE OF AUTHORITY #00704

JACOBS ENGINEERING GROUP
501 NORTH BROADWAY
ST. LOUIS, MISSOURI 63102-2121
PHONE: (314) 335-4000
CERTIFICATE OF AUTHORITY #00704

IF A SEAL IS PRESENT ON THIS SHEET IT HAS BEEN ELECTRONICALLY SEALED AND DATED:

SHARED USE PATH CROSS SECTIONS

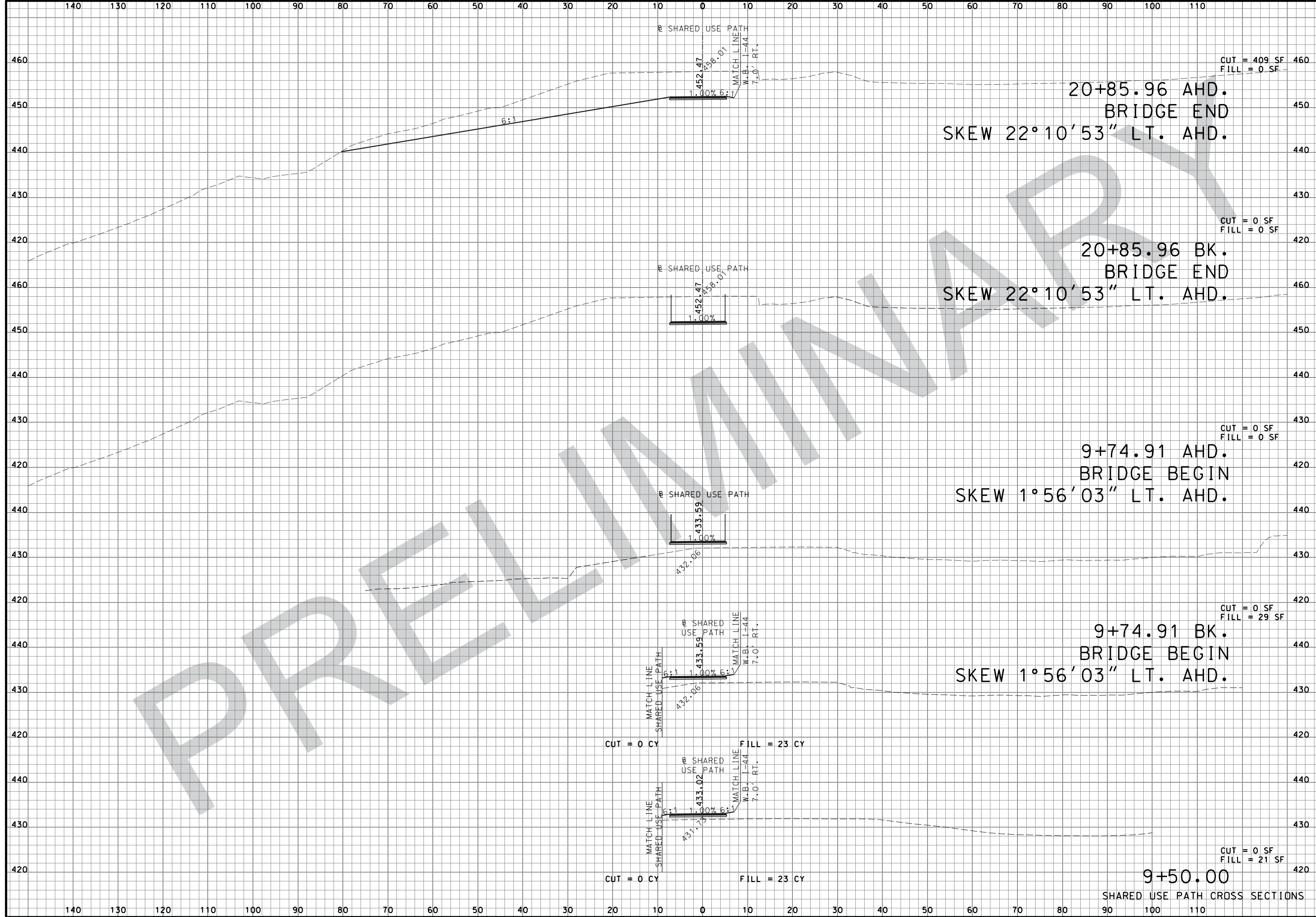

"THIS MEDIA SHOULD NOT BE CONSIDERED A CERTIFIED DOCUMENT."

DATE PREPARED 08-FEB-2018	
ROUTE I-44	STATE MO
DISTRICT SL	SHEET NO. XS73
COUNTY ST. LOUIS	
JOB NO. J613029	
CONTRACT ID.	
PROJECT NO.	
BRIDGE NO.	

DATE	DESCRIPTION

MISSOURI HIGHWAYS AND TRANSPORTATION COMMISSION

105 WEST CAPITOL
JEFFERSON CITY, MO 65102
1-888-ASK-MODOT (1-888-275-6636)

JACOBS ENGINEERING GROUP
501 NORTH BROADWAY
ST. LOUIS, MISSOURI 63102-2121
PHONE: (314) 335-4000
CERTIFICATE OF AUTHORITY #00704

IF A SEAL IS PRESENT ON THIS SHEET IT HAS BEEN ELECTRONICALLY SEALED AND DATED.

SHARED USE PATH CROSS SECTIONS

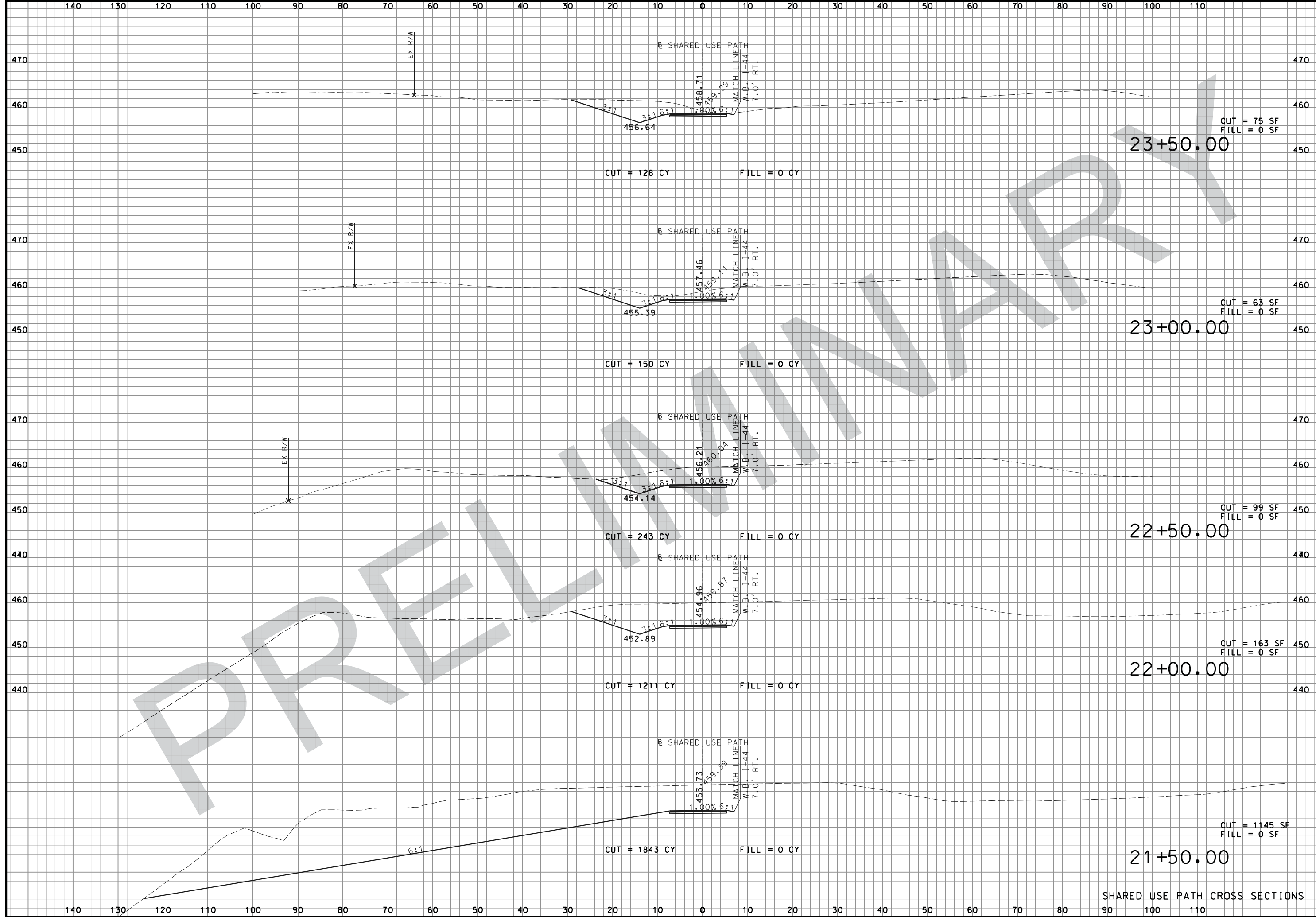

"THIS MEDIA SHOULD NOT BE CONSIDERED A CERTIFIED DOCUMENT."

DATE PREPARED
08-FEB-2018

ROUTE I-44 STATE MO

DISTRICT SL SHEET NO. XS74

COUNTY ST. LOUIS

JOB NO. J613029

CONTRACT ID.

PROJECT NO.

BRIDGE NO.

DESCRIPTION	DATE

MISSOURI HIGHWAYS AND TRANSPORTATION COMMISSION

MODOT

105 WEST CAPITOL
JEFFERSON CITY, MO 65102
1-888-ASK-MODOT (1-888-275-6636)

JACOBS

JACOBS ENGINEERING GROUP
501 NORTH BROADWAY
ST. LOUIS, MISSOURI 63102-2121
PHONE: (314) 336-4000
CERTIFICATE OF AUTHORITY #00704

SHARED USE PATH CROSS SECTIONS

IF A SEAL IS PRESENT ON THIS SHEET IT HAS BEEN ELECTRONICALLY SEALED AND DATED:

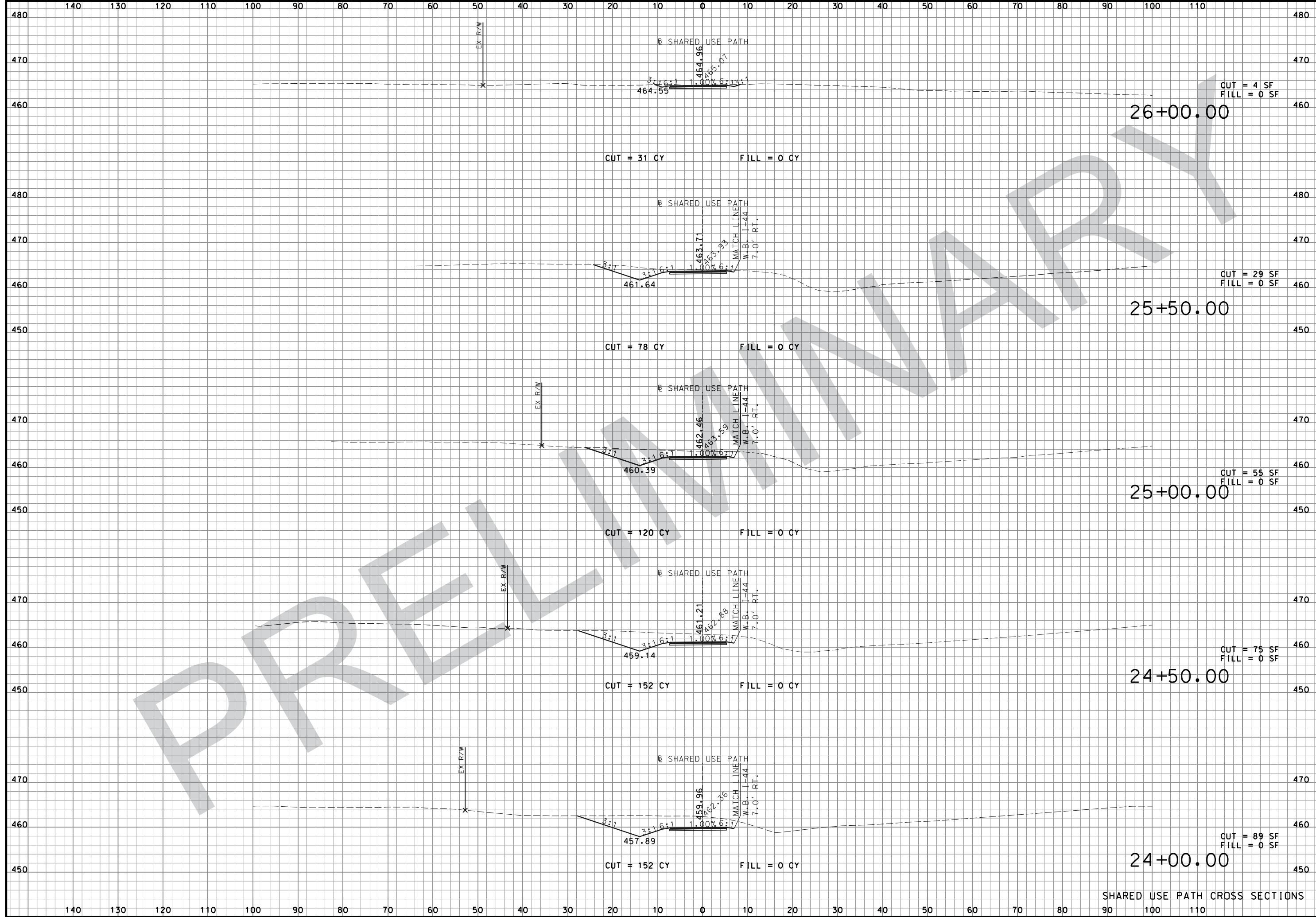

"THIS MEDIA SHOULD NOT BE CONSIDERED A CERTIFIED DOCUMENT."

DATE PREPARED 08-FEB-2018	
ROUTE I-44	STATE MO
DISTRICT SL	SHEET NO. XS75
COUNTY ST. LOUIS	
JOB NO. J613029	
CONTRACT ID.	
PROJECT NO.	
BRIDGE NO.	

DESCRIPTION	DATE

MISSOURI HIGHWAYS AND TRANSPORTATION COMMISSION

105 WEST CAPITOL
JEFFERSON CITY, MO 65102
1-888-ASK-MODOT (1-888-275-6636)

JACOBS
 JACOBS ENGINEERING GROUP
 501 NORTH BROADWAY
 ST. LOUIS, MISSOURI 63102-2121
 PHONE: (314) 335-4000
 CERTIFICATE OF AUTHORITY #00704

SHARED USE PATH CROSS SECTIONS

IF A SEAL IS PRESENT ON THIS SHEET IT HAS BEEN ELECTRONICALLY SEALED AND DATED:

140 130 120 110 100 90 80 70 60 50 40 30 20 10 0 10 20 30 40 50 60 70 80 90 100 110

"THIS MEDIA SHOULD NOT BE CONSIDERED A CERTIFIED DOCUMENT."

DATE PREPARED
08-FEB-2018

ROUTE STATE
I-44 MO

DISTRICT SHEET NO.
SL XS76

COUNTY
ST. LOUIS

JOB NO.
J613029

CONTRACT ID.

PROJECT NO.

BRIDGE NO.

DATE	DESCRIPTION

MISSOURI HIGHWAYS AND TRANSPORTATION COMMISSION



105 WEST CAPITOL
JEFFERSON CITY, MO 65102
1-888-ASK-MODOT (1-888-275-6636)

JACOBS

JACOBS ENGINEERING GROUP
501 NORTH BROADWAY
ST. LOUIS, MISSOURI 63102-2121
PHONE: (314) 335-4000
CERTIFICATE OF AUTHORITY #00704

IF A SEAL IS PRESENT ON THIS SHEET IT HAS BEEN ELECTRONICALLY SEALED AND DATED:

PRELIMINARY

480
470
460

480
470
460

SHARED USE PATH

1.465:1.15
1.00% 6:13:1

CUT = 1 CY

FILL = 0 CY

CUT = 1 SF
FILL = 0 SF

26+07.94

SHARED USE PATH CROSS SECTIONS

140 130 120 110 100 90 80 70 60 50 40 30 20 10 0 10 20 30 40 50 60 70 80 90 100 110

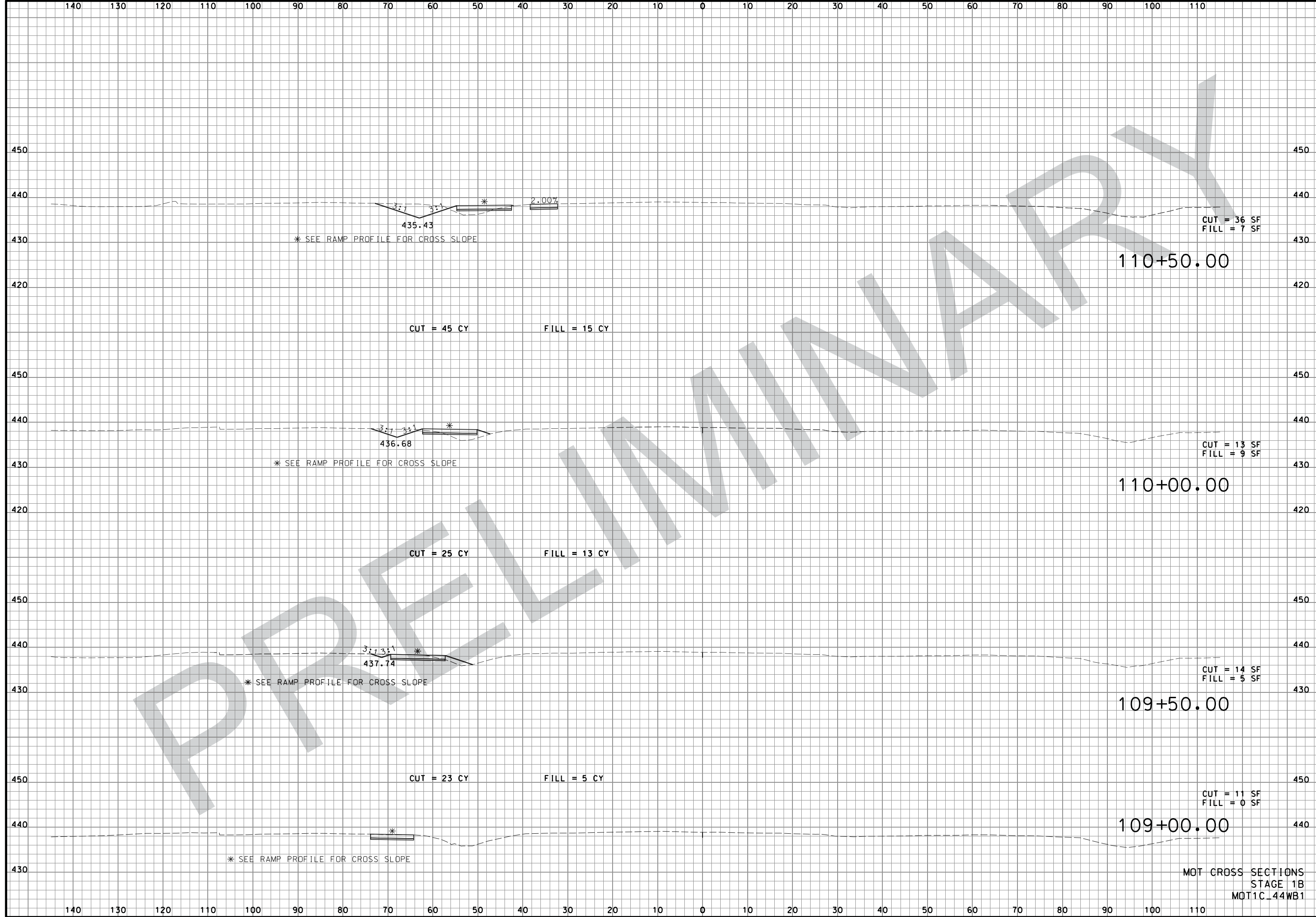

"THIS MEDIA SHOULD NOT BE CONSIDERED A CERTIFIED DOCUMENT."

DATE PREPARED
08-FEB-2018

ROUTE STATE
I-44 MO

DISTRICT SHEET NO.
SL XS77

COUNTY
ST. LOUIS

JOB NO.
J613029

CONTRACT ID.

PROJECT NO.

BRIDGE NO.

DATE	DESCRIPTION

MISSOURI HIGHWAYS AND TRANSPORTATION COMMISSION



MOT CROSS SECTIONS
 STAGE 1B
 MOT1C_44WB1

IF A SEAL IS PRESENT ON THIS SHEET IT HAS BEEN ELECTRONICALLY SEALED AND DATED:

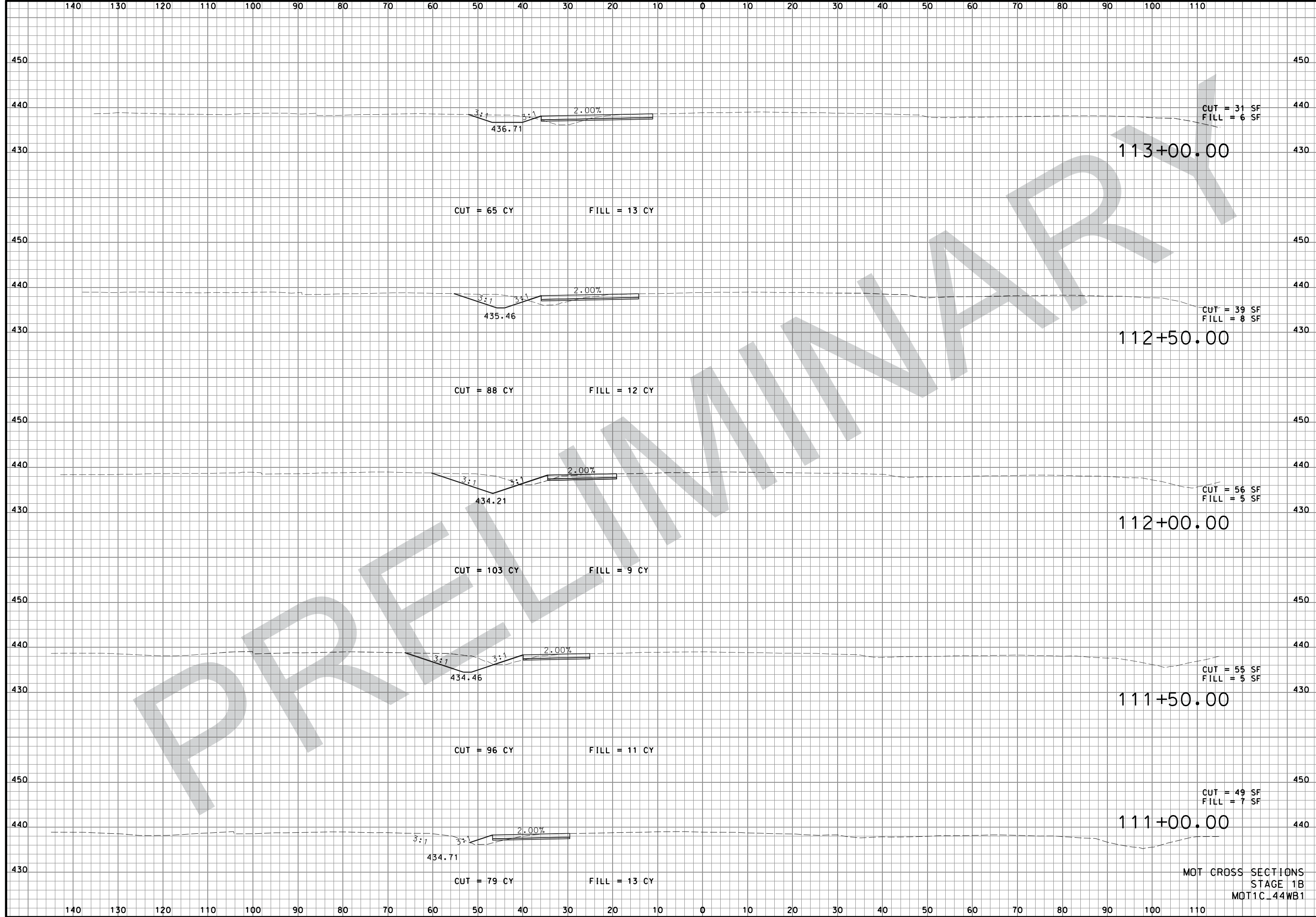

"THIS MEDIA SHOULD NOT BE CONSIDERED A CERTIFIED DOCUMENT."

DATE PREPARED 08-FEB-2018	
ROUTE I-44	STATE MO
DISTRICT SL	SHEET NO. XS78
COUNTY ST. LOUIS	
JOB NO. J613029	
CONTRACT ID.	
PROJECT NO.	
BRIDGE NO.	

DATE	DESCRIPTION

MISSOURI HIGHWAYS AND TRANSPORTATION COMMISSION

105 WEST CAPITOL
JEFFERSON CITY, MO 65102
1-888-ASK-MODOT (1-888-275-6636)

JACOBS ENGINEERING GROUP
501 NORTH BROADWAY
ST. LOUIS, MISSOURI 63102-2121
PHONE: (314) 335-4000
CERTIFICATE OF AUTHORITY #00704

MOT CROSS SECTIONS
STAGE 1B
MOT1C_44WB1



"THIS MEDIA SHOULD NOT BE CONSIDERED A CERTIFIED DOCUMENT."

DATE PREPARED
 08-FEB-2018

ROUTE	STATE
I-44	MO
DISTRICT	SHEET NO.
SL	XS79

COUNTY
 ST. LOUIS

JOB NO.
 J613029

CONTRACT ID.

PROJECT NO.
 BRIDGE NO.

DATE	DESCRIPTION

MISSOURI HIGHWAYS AND TRANSPORTATION COMMISSION

105 WEST CAPITOL
 JEFFERSON CITY, MO 65102
 1-888-ASK-MODOT (1-888-275-6636)

JACOBS

JACOBS ENGINEERING GROUP
 501 NORTH BROADWAY
 ST. LOUIS, MISSOURI 63102-2121
 PHONE: (314) 335-4000
 CERTIFICATE OF AUTHORITY #00704

MOT CROSS SECTIONS
 STAGE 1B
 MOT1C_44WB1

IF A SEAL IS PRESENT ON THIS SHEET IT HAS BEEN ELECTRONICALLY SEALED AND DATED:

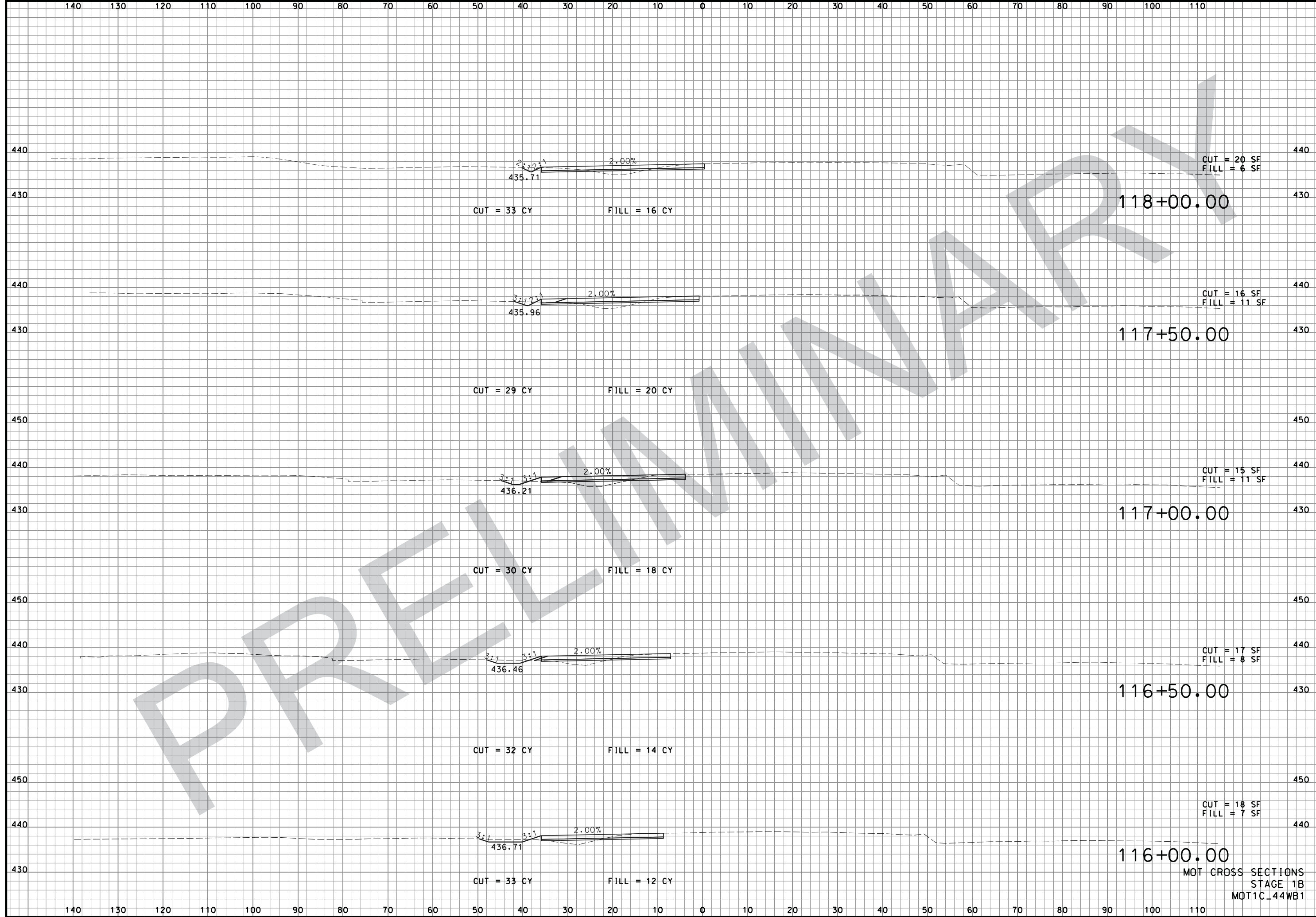

"THIS MEDIA SHOULD NOT BE CONSIDERED A CERTIFIED DOCUMENT."

DATE PREPARED
08-FEB-2018

ROUTE	STATE
I-44	MO
DISTRICT	SHEET NO.
SL	XS80

COUNTY	JOB NO.
ST. LOUIS	J613029
CONTRACT ID.	

PROJECT NO.

BRIDGE NO.

DATE	DESCRIPTION

MISSOURI HIGHWAYS AND TRANSPORTATION COMMISSION



JACOBS
 JACOBS ENGINEERING GROUP
 501 NORTH BROADWAY
 ST. LOUIS, MISSOURI 63102-2121
 PHONE: (314) 335-4000
 CERTIFICATE OF AUTHORITY #00704

IF A SEAL IS PRESENT ON THIS SHEET IT HAS BEEN ELECTRONICALLY SEALED AND DATED:

MOT CROSS SECTIONS
 STAGE 1B
 MOT1C_44WB1

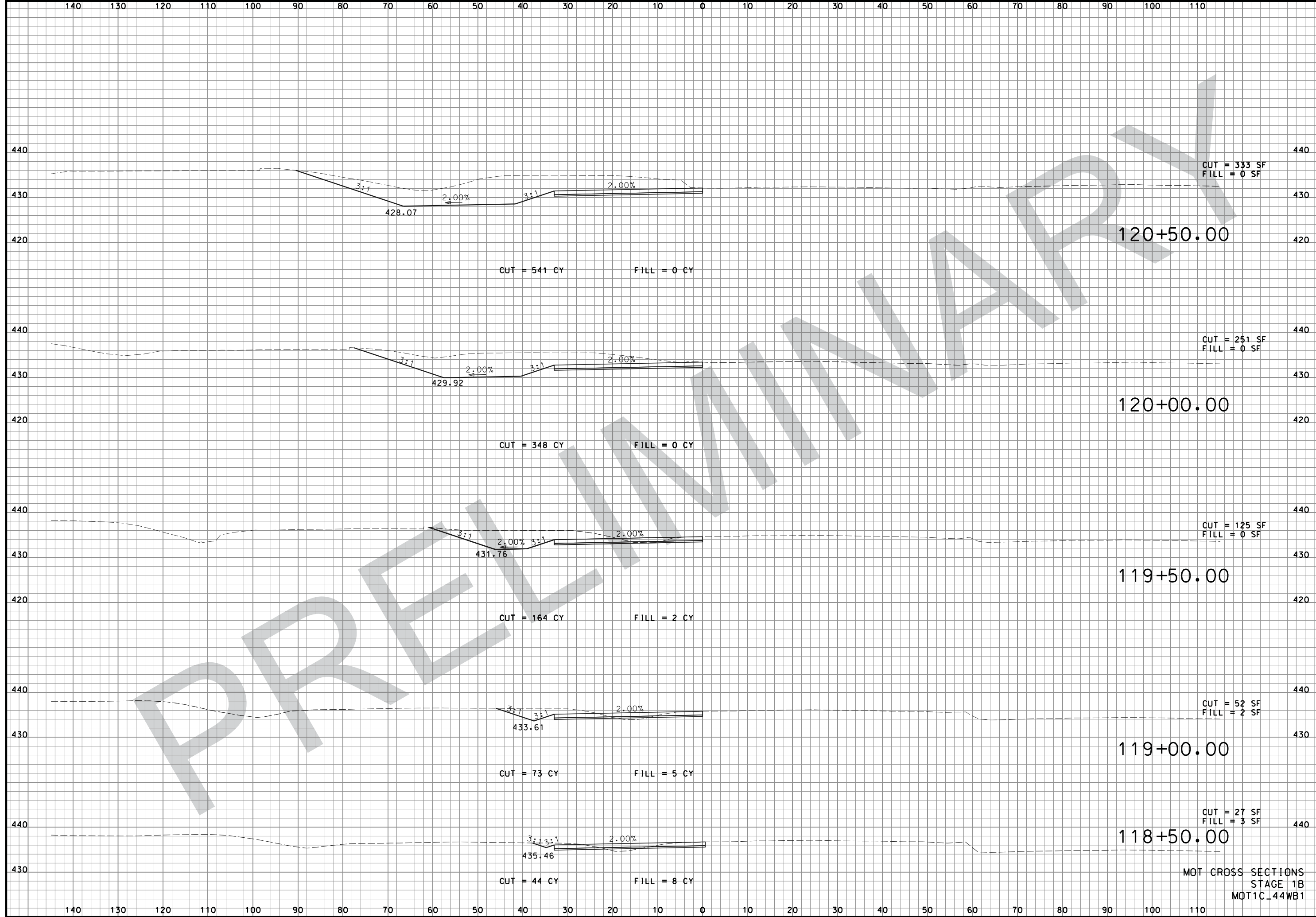

"THIS MEDIA SHOULD NOT BE CONSIDERED A CERTIFIED DOCUMENT."

DATE PREPARED
 08-FEB-2018

ROUTE STATE
 I-44 MO

DISTRICT SHEET NO.
 SL XS81

COUNTY
 ST. LOUIS

JOB NO.
 J613029

CONTRACT ID.

PROJECT NO.
 BRIDGE NO.

DATE	DESCRIPTION

MISSOURI HIGHWAYS AND TRANSPORTATION COMMISSION

MODOT

105 WEST CAPITOL
 JEFFERSON CITY, MO 65102
 1-888-ASK-MODOT (1-888-275-6636)

JACOBS

JACOBS ENGINEERING GROUP
 501 NORTH BROADWAY
 ST. LOUIS, MISSOURI 63102-2121
 PHONE: (314) 335-4000
 CERTIFICATE OF AUTHORITY #00704

MOT CROSS SECTIONS
 STAGE 1B
 MOT1C_44WB1

IF A SEAL IS PRESENT ON THIS SHEET IT HAS BEEN ELECTRONICALLY SEALED AND DATED:

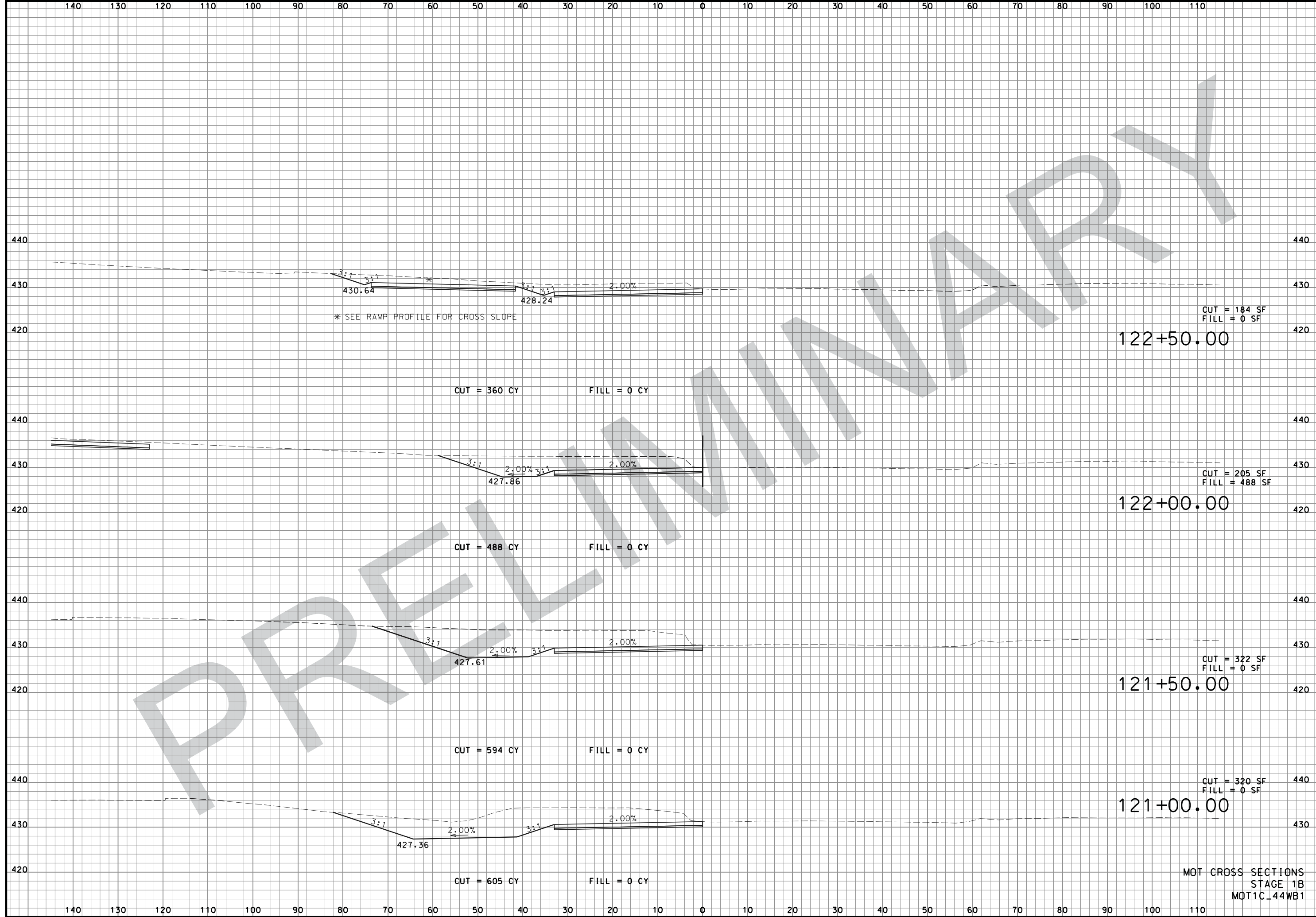

"THIS MEDIA SHOULD NOT BE CONSIDERED A CERTIFIED DOCUMENT."

DATE PREPARED
 08-FEB-2018
 ROUTE I-44 STATE MO
 DISTRICT SL SHEET NO. XS82
 COUNTY ST. LOUIS
 JOB NO. J613029
 CONTRACT ID.

PROJECT NO.
 BRIDGE NO.

DATE	DESCRIPTION

MISSOURI HIGHWAYS AND TRANSPORTATION COMMISSION

 105 WEST CAPITOL
 JEFFERSON CITY, MO 65102
 1-888-ASK-MODOT (1-888-275-6636)

JACOBS
 JACOBS ENGINEERING GROUP
 501 NORTH BROADWAY
 ST. LOUIS, MISSOURI 63102-2121
 PHONE: (314) 335-4000
 CERTIFICATE OF AUTHORITY #00704

MOT CROSS SECTIONS
 STAGE 1B
 MOT1C_44WB1

IF A SEAL IS PRESENT ON THIS SHEET IT HAS BEEN ELECTRONICALLY SEALED AND DATED:

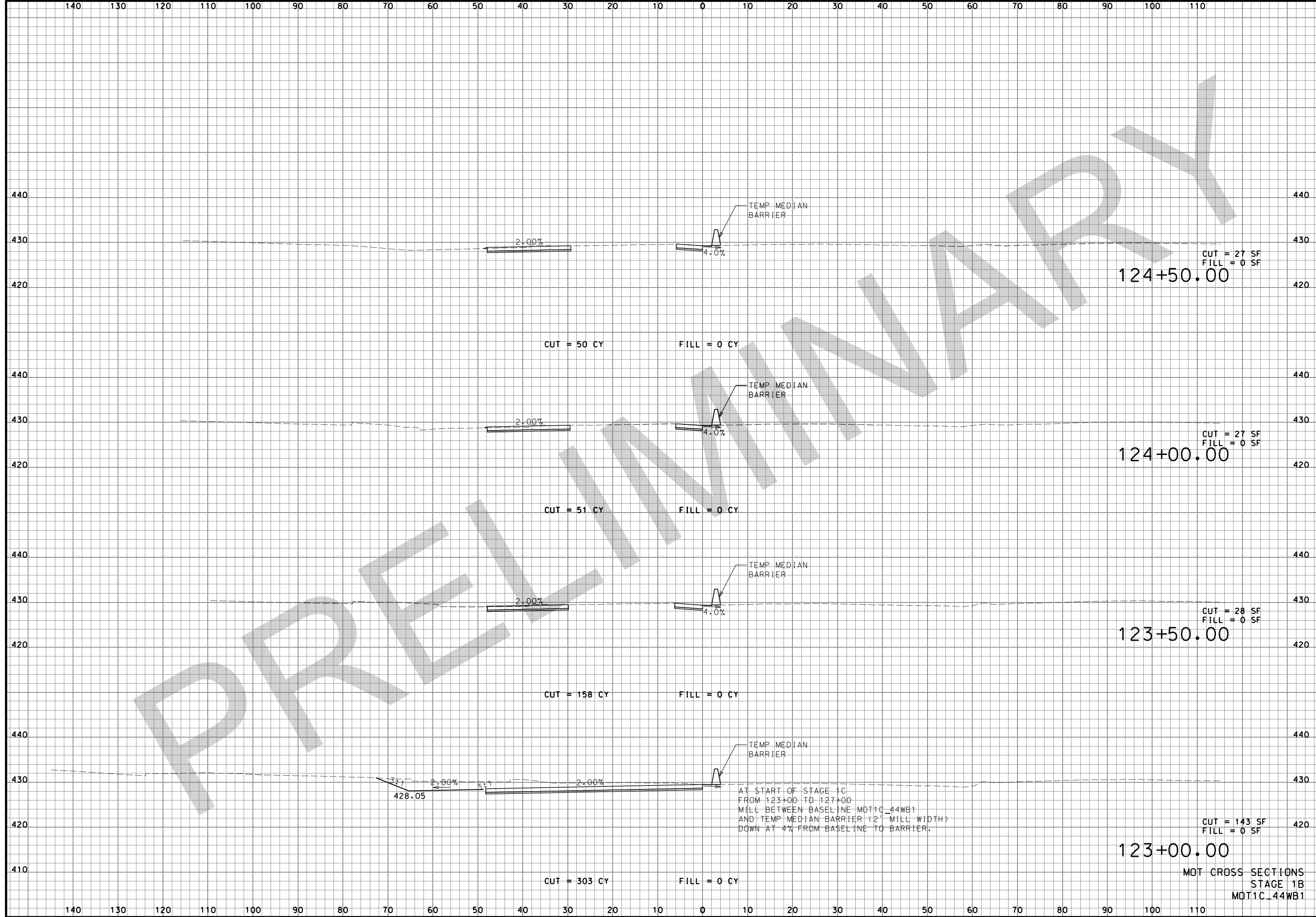

"THIS MEDIA SHOULD NOT BE CONSIDERED A CERTIFIED DOCUMENT."

DATE PREPARED
08-FEB-2018

ROUTE	STATE
I-44	MO
DISTRICT	SHEET NO.
SL	XS83

COUNTY
ST. LOUIS

JOB NO.
J613029

CONTRACT ID.

PROJECT NO.

BRIDGE NO.

DATE	DESCRIPTION

MISSOURI HIGHWAYS AND TRANSPORTATION COMMISSION



105 WEST CAPITOL
JEFFERSON CITY, MO 65102
1-888-ASK-MODOT (1-888-275-6636)

JACOBS

JACOBS ENGINEERING GROUP
501 NORTH BROADWAY
ST. LOUIS, MISSOURI 63102-2121
PHONE: (314) 335-4000
CERTIFICATE OF AUTHORITY #00704

IF A SEAL IS PRESENT ON THIS SHEET IT HAS BEEN ELECTRONICALLY SEALED AND DATED:

MOT CROSS SECTIONS
STAGE 1B
MOT1C_44WB1

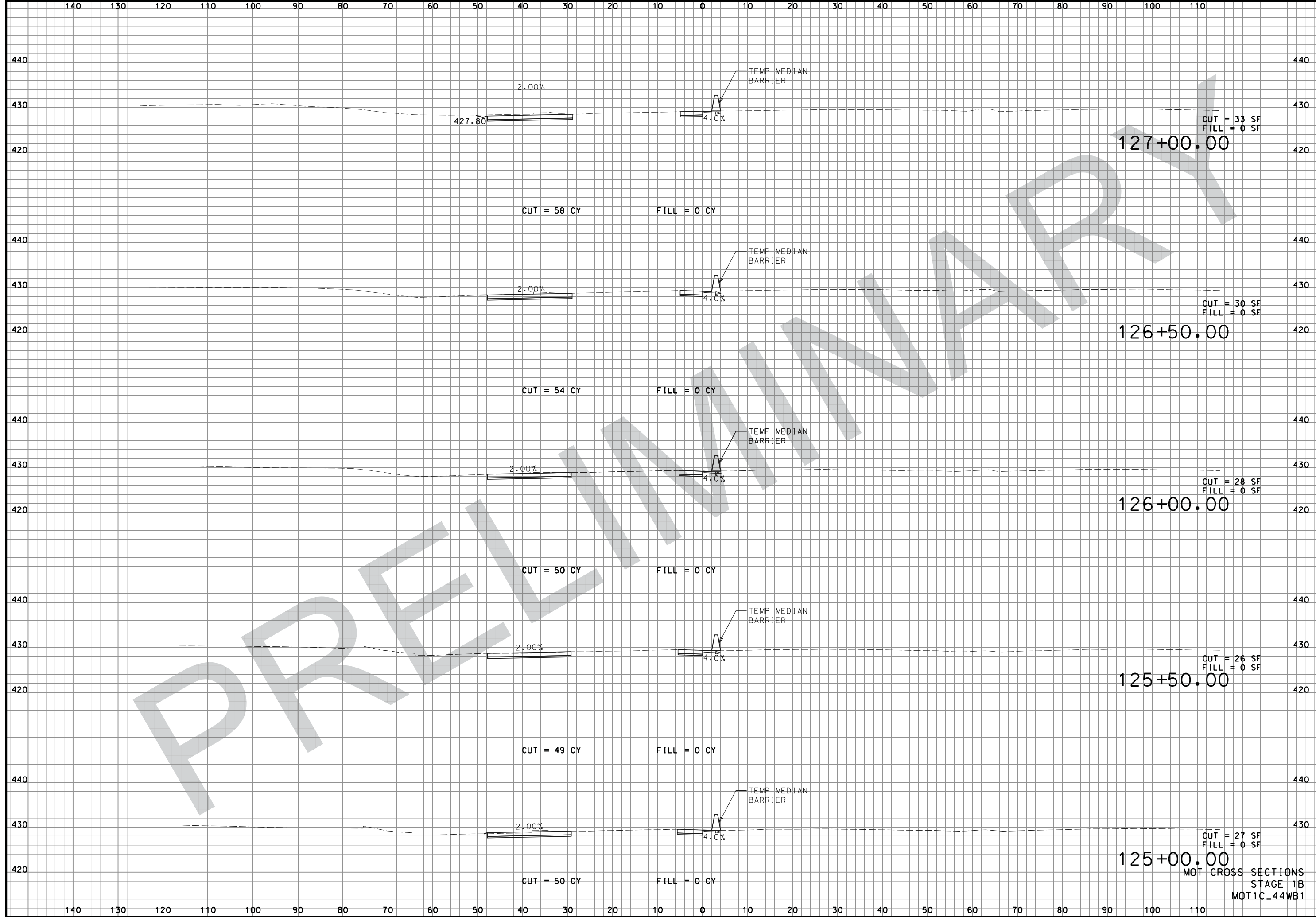

"THIS MEDIA SHOULD NOT BE CONSIDERED A CERTIFIED DOCUMENT."

DATE PREPARED
08-FEB-2018

ROUTE STATE
I-44 MO

DISTRICT SHEET NO.
SL XS84

COUNTY
ST. LOUIS

JOB NO.
J613029

CONTRACT ID.

PROJECT NO.

BRIDGE NO.

DESCRIPTION	DATE

MISSOURI HIGHWAYS AND TRANSPORTATION COMMISSION



105 WEST CAPITOL
JEFFERSON CITY, MO 65102
1-888-ASK-MODOT (1-888-275-6636)

JACOBS

JACOBS ENGINEERING GROUP
501 NORTH BROADWAY
ST. LOUIS, MISSOURI 63102-2121
PHONE: (314) 335-4000
CERTIFICATE OF AUTHORITY #00704

MOT CROSS SECTIONS
STAGE 1B
MOT1C_44WB1

IF A SEAL IS PRESENT ON THIS SHEET IT HAS BEEN ELECTRONICALLY SEALED AND DATED:

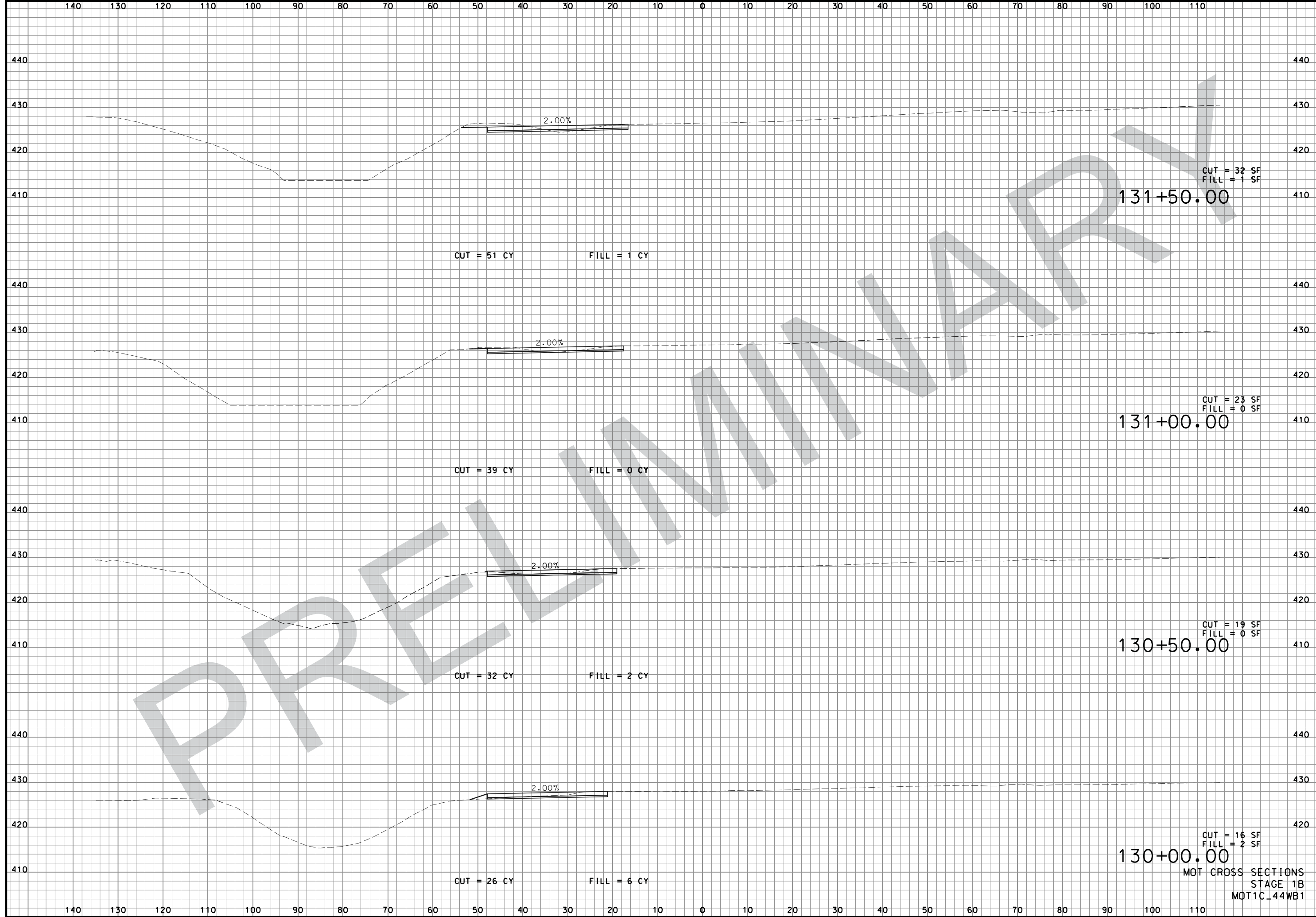

"THIS MEDIA SHOULD NOT BE CONSIDERED A CERTIFIED DOCUMENT."

DATE PREPARED
08-FEB-2018

ROUTE	STATE
I-44	MO
DISTRICT	SHEET NO.
SL	XS86

COUNTY
ST. LOUIS

JOB NO.
J613029

CONTRACT ID.

PROJECT NO.
BRIDGE NO.

DATE	DESCRIPTION

MISSOURI HIGHWAYS AND TRANSPORTATION COMMISSION



105 WEST CAPITOL
JEFFERSON CITY, MO 65102
1-888-ASK-MODOT (1-888-275-6636)

JACOBS

JACOBS ENGINEERING GROUP
501 NORTH BROADWAY
ST. LOUIS, MISSOURI 63102-2121
PHONE: (314) 335-4000
CERTIFICATE OF AUTHORITY #00704

MOT CROSS SECTIONS
STAGE 1B
MOT1C_44WB1

IF A SEAL IS PRESENT ON THIS SHEET IT HAS BEEN ELECTRONICALLY SEALED AND DATED.



"THIS MEDIA SHOULD NOT BE CONSIDERED A CERTIFIED DOCUMENT."

DATE PREPARED
 08-FEB-2018
 ROUTE STATE
 I-44 MO
 DISTRICT SHEET NO.
 SL XS87
 COUNTY
 ST. LOUIS
 JOB NO.
 J613029
 CONTRACT ID.

PROJECT NO.
 BRIDGE NO.

DATE	DESCRIPTION

MISSOURI HIGHWAYS AND TRANSPORTATION COMMISSION

 105 WEST CAPITOL
 JEFFERSON CITY, MO 65102
 1-888-ASK-MODOT (1-888-275-6636)

JACOBS
 JACOBS ENGINEERING GROUP
 501 NORTH BROADWAY
 ST. LOUIS, MISSOURI 63102-2121
 PHONE: (314) 335-4000
 CERTIFICATE OF AUTHORITY #00704

MOT CROSS SECTIONS
 STAGE 1B
 MOT1C_44WB1

IF A SEAL IS PRESENT ON THIS SHEET IT HAS BEEN ELECTRONICALLY SEALED AND DATED:



"THIS MEDIA SHOULD NOT BE CONSIDERED A CERTIFIED DOCUMENT."

DATE PREPARED
08-FEB-2018
ROUTE I-44 STATE MO
DISTRICT SL SHEET NO. XS88
COUNTY ST. LOUIS
JOB NO. J613029
CONTRACT ID.

PROJECT NO.
BRIDGE NO.

DATE	DESCRIPTION

MISSOURI HIGHWAYS AND TRANSPORTATION COMMISSION

 105 WEST CAPITOL
 JEFFERSON CITY, MO 65102
 1-888-ASK-MODOT (1-888-275-6636)

JACOBS
 JACOBS ENGINEERING GROUP
 501 NORTH BROADWAY
 ST. LOUIS, MISSOURI 63102-2121
 PHONE: (314) 336-4000
 CERTIFICATE OF AUTHORITY #00704

MOT CROSS SECTIONS
 STAGE 1B
 MOT1C_44WB1

IF A SEAL IS PRESENT ON THIS SHEET IT HAS BEEN ELECTRONICALLY SEALED AND DATED:

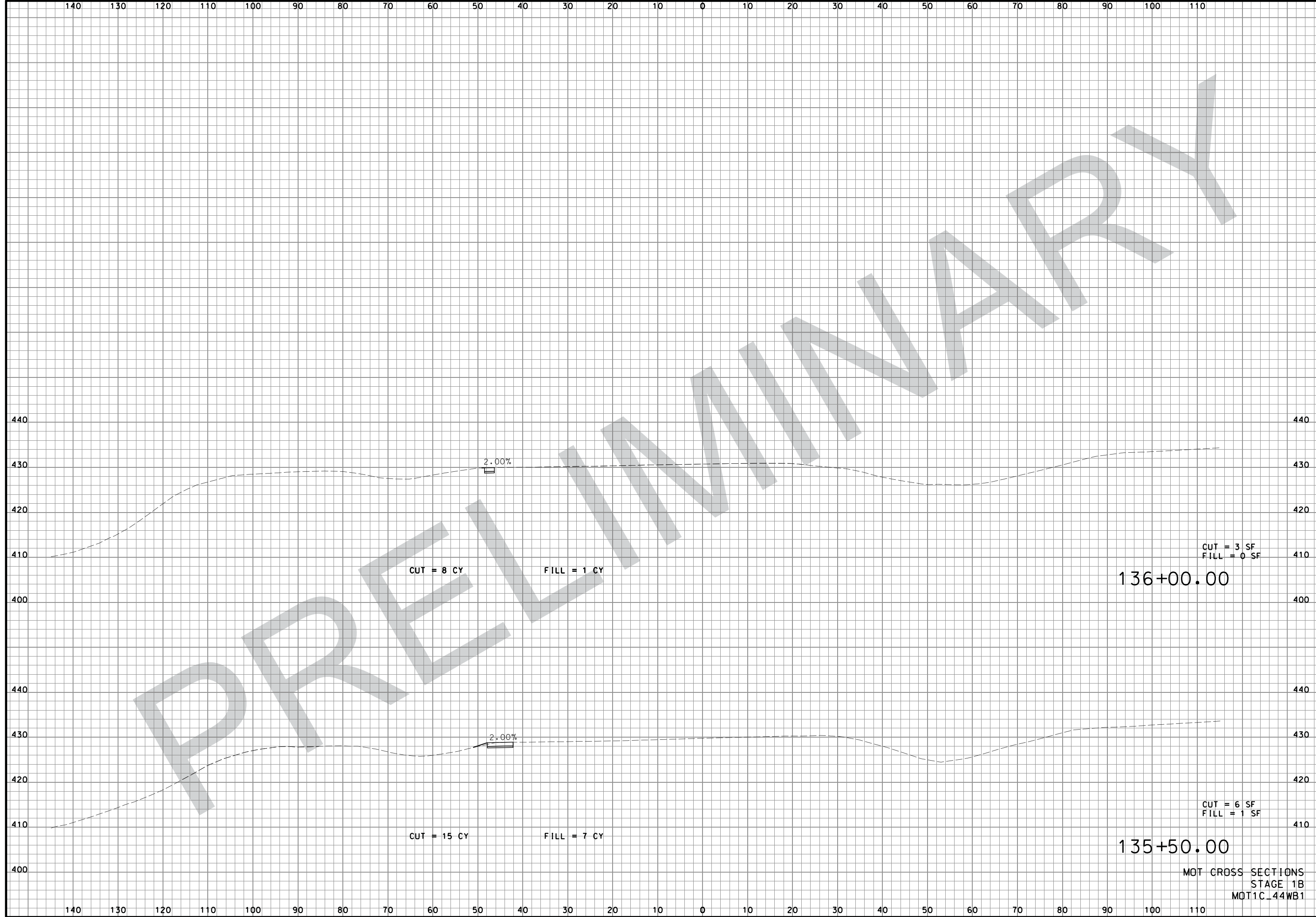

"THIS MEDIA SHOULD NOT BE CONSIDERED A CERTIFIED DOCUMENT."

DATE PREPARED
08-FEB-2018

ROUTE I-44	STATE MO
---------------	-------------

DISTRICT SL	SHEET NO. XS89
----------------	-------------------

COUNTY
ST. LOUIS

JOB NO.
J613029

CONTRACT ID.

PROJECT NO.

BRIDGE NO.

DATE	DESCRIPTION

MISSOURI HIGHWAYS AND TRANSPORTATION COMMISSION

105 WEST CAPITOL
JEFFERSON CITY, MO 65102
1-888-ASK-MODOT (1-888-275-6636)

JACOBS ENGINEERING GROUP
501 NORTH BROADWAY
ST. LOUIS, MISSOURI 63102-2121
PHONE: (314) 335-4000
CERTIFICATE OF AUTHORITY #00704

MOT CROSS SECTIONS
STAGE 1B
MOT1C_44WB1

IF A SEAL IS PRESENT ON THIS SHEET IT HAS BEEN ELECTRONICALLY SEALED AND DATED: