

# RECEIPT OF ADDENDUM

I received addendum No. # 02 for November 25, 2024  
Albany Avenue Pedestrian and Stormwater Improvements  
Federal: TAP-6701(807)  
ARPA: AB82D393425B  
GRE: 4689

This addendum involves 43 pages including this sheet.

---

Vendor's Name

---

---

Vendor's Address

---

Signature / Date

**Return completed acknowledgment to  
Great River Engineering ASAP**

**Email Back to:**

**[Secretary@greatriv.com](mailto:Secretary@greatriv.com)**

**OR**

**Fax # 417-886-7591**

**Attention: Ramona Giddens**

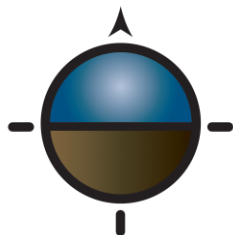

**GRE**  
GREAT RIVER  
ENGINEERING

## ADDENDUM NO. 2

**ISSUED BY:** Great River Engineering  
2826 S. Ingram Mill Road  
Springfield, Missouri 65804  
(417) 886-7171  
(417) 886-7591 -- FAX

**DATE:** November 25, 2024

**FOR PROJECT:** **Albany Avenue Pedestrian and Stormwater Improvements**  
**Federal: TAP-6701(807)**  
**ARPA: AB82D393425B**  
**GRE: 4689**

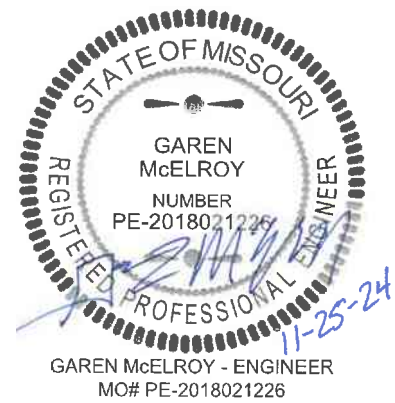

This Addendum is applicable to work herein and shall be understood to be and is an Addendum, and as such shall be a part and included in the Contract. IT IS ESSENTIAL THAT ALL BIDDERS, CONTRACTORS, SUBCONTRACTORS, AND ALL MATERIAL SUPPLIERS READ ALL SECTIONS OF THIS ADDENDUM.

### **Pre-Bid Meeting:**

A pre-bid meeting was held at the office of Great River Engineering at 2826 S. Ingram Mill Road, Springfield, MO 65804 on Tuesday, November 19, 2024 at 3:00 PM with a virtual meeting option provided. The sign-in sheet and agenda (with minutes) from this meeting are attached to this addendum for reference.

### **Bid Documents Book:**

Remove and replace pages 132 – 166 (Federal Wage Rates) with the attached pages. The Federal Wage Rates have been updated, and in accordance with the “10-Day Rule,” the Federal Wage Rates applicable to this project shall be those effective 11/22/2024 (attached).

### **Contract Drawings:**

Sheet 21 – Structural Details  
Details have been added for the double-cell box-culvert connections.

### **Contractor Inquiries:**

1. How will the add alternates be awarded?  
*Add alternates will be awarded based on the combination of base plus add alternate sections that allow the most work to be completed within the Owner’s budget. The award of add alternates will be selected in accordance with the following priorities:*
  - i. Base
  - ii. Base + Add Alt. A
  - iii. Base + Add Alt. A + Add Alt. B
  - iv. Base + Add Alt. A + Add Alt. B + Add Alt. C*Refer to JSP 5 – ADD ALTERNATES for more information*
  
2. Will the construction budget be made available after bids have opened  
Yes

3. Who pays for testing on this project?

*This project will follow the standard LPA processes for testing and inspection. Testing for the inspection of work in accordance with JSP 16 – INSPECTION OF WORK will be completed by the Engineer and paid for by the Owner. Any testing required for material certifications will not be paid for or performed by the Owner.*

**Job Special Provisions:**

Add the following to the Job Special Provisions:

**“67. DRAIN CLOSING AND SEALING**

All work and materials required for the completion of removing and patching existing drain openings in the existing 8’x4’ box culvert shall be paid for under bid item #30. Completed patches which will be exposed and utilized as the trail surface (two westernmost openings) shall be ADA compliant.”

**“68. BOX CULVERT, WING WALL, HEADWALL, AND CONNECTION WALL REINFORCEMENT**

All work and materials, including reinforcement and coupler connections, required for the construction of the box culverts shall be paid for under bid items #21 – 5’X5’ Double-Cell Box Culvert and #23 – Class B-1 Concrete for Wing Walls, Headwalls and Connection Walls.”

**“69. ARTICULATED CONCRETE BLOCK (ACB)**

ArmorFlex Class 50 or approved equal shall be used in lieu of Type 2 Rock Ditch Liner for Bid Add Alternate B.

The contractor shall furnish all labor, materials, equipment, and incidentals required for, and perform all operations in connection with, the installation of the Articulating Concrete Block (ACB) system in accordance with the lines, grades, design and dimensions shown on the Contract Drawings and as specified by the manufacturer.”

**END OF ADDENDUM NO. 2**

**ATTACHMENTS:**

**Pre-Bid Meeting Minutes with included download link for meeting audio recording (4 pages)**  
**Updated Federal Wage Rates, Effective 11/22/2024 (35 pages)**  
**Revised Plan Sheet 21 – Structural Details (1 page)**



# ALBANY AVENUE PEDESTRIAN AND STORMWATER IMPROVEMENTS

## PRE-BID MEETING – Minutes

Tuesday, November 19, 2024; 3:00 PM  
Great River Engineering – Springfield Office  
2826 S. Ingram Mill Rd., Springfield, MO 65804  
GRE 4689 | TAP-6701(807) | ARPA AB82D393425B

[Online Meeting Link](#) (Microsoft Teams)

Meeting ID: 285 144 380 167

Passcode: fPeMMT

[Link to minutes and audio recording](#) – [Download Link](#)

## AGENDA

1. Introductions
  - a. GRE Staff
    - i. Project Manager: Garen McElroy, PE
    - ii. Project Engineer: Austin Hostettler, EIT
    - iii. Construction Phase Manager: Bryan Boyce
  - b. City of Bolivar
    - i. Community Development Director: Kyle Lee
    - ii. Community Development Coordinator: Kevin Kelly
  - c. Also in Attendance
    - i. Justin Wallace – JD Wallace Contracting
    - ii. Jim McDiarmid – MoDOT
    - iii. Josh Dugan – MoDOT
    - iv. Todd Black – Contech
2. Welcome
  - a. Welcome address and meeting purpose
  - b. Sign in sheet

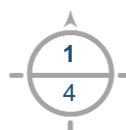



## Pre-Bid Meeting



- c. Meeting minutes and audio recording of the meeting will be shared via addendum
3. Project Overview
- a. Project Location: Albany Avenue between Walnut Street and Springfield Avenue
  - b. Project Owner: City of Bolivar
  - c. Scope of Work
    - i. Construction of a multi-use ADA compliant path, ditch improvements, box culvert installation, stormwater improvements, and roadway improvements.
  - d. Bidding Alternates
    - i. Alternate A: Asphalt pavement option
    - ii. Alternate B: Use Articulated Concrete Block (ACB) in place of Type 2 Rock Ditch Liner
    - iii. Alternate C: Replace section of existing 8'x4' Box Culvert
4. Bidding Provisions
- a. Project will be awarded to the lowest, responsive, responsible bidder. Owner reserves the right to reject any or all bids for sound, documented reasons.
  - b. Bid Opening: Wednesday, December 4, 2024; 11:00 AM  
City of Bolivar City Hall  
345 S. Main Ave.  
Bolivar, MO 65613
    - i. Bids will be accepted from registered planholders listed on the Engineer's Planholder List. Bids will be received at City of Bolivar City Hall until the date and time of the Bid Opening.
  - c. Bidding Contract Documents are available in electronic format on flash drive or through an electronic download link from Great River Engineering's Springfield office.
    - i. Email: [secretary@greatriv.com](mailto:secretary@greatriv.com)
  - d. DBE goal: 0%
  - e. Prevailing State and Federal Wage Rates are required for this project.
  - f. Acknowledgement of all Addendums is required.
  - g. Bid Bond: 5%
  - h. Bid Acceptance Period: 60 days
  - i. Liquidated Damages: \$1,100/Day

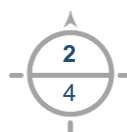



## Pre-Bid Meeting



- j. Project is Tax Exempt.
  - k. Reference the Bid Documents Book for a list of required attachments to be submitted with the Bid.
5. Project Schedule
- a. Dec 4 – Bid Opening
  - b. Jan 3 – Anticipated Notice of Award
  - c. TBD – Pre-Construction Meeting
  - d. Jan 15 – Anticipated Notice to Proceed with Box Culvert Procurement
  - e. Jun 16 – \*Anticipated Notice to Proceed with Construction
  - f. Dec 27 – \*Project Completion (360 Calendar Days\*)

\* Flexible dates depending on ability to procure box culvert(s)

6. Key Project Elements and Requirements

- a. Refer to the Bid Documents Book for all Job Special Provisions.
  - i. Lump Sum Bid Items
    - Concrete Vault Removal
    - Concrete Box Culvert Removal
    - Removal of Improvements
    - Mobilization
- b. Federal ARPA Requirements
  - i. Goal for Minority Participation for Each Trade: 2.3%
  - ii. Goal for Female Participation in Each Trade: 6.9%
  - iii. The following is required to be submitted with the Bid in addition to the attachments listed in the Bidder's Checklist
    - MoDNR Certification Regarding Debarment and Suspension
    - Certification of Nonsegregated Facilities
    - Business Entity Certification, Enrollment Documentation, and Affidavit of Work Authorization
    - Domestic Products Procurement Act – RSMo 34.350 – 34.359 Certification
    - Certification Regarding Lobbying & Disclosure of Lobbying Activities



iv. The following is **requested** to be submitted with the Bid in addition to the required attachments

- Sample/Template Pay Request Invoice specific to this project.

7. Utilities

- a. Utility contacts are shown on the plans.
- b. Awaiting relocation plan from Empire (Liberty) Electric
- c. All other utilities have confirmed no other conflicts exist.

8. Addendums

- a. Published: 1
  - i. Addendum 1: moved the date of the Pre-Bid Meeting
- b. Upcoming:
  - i. TBD

9. Question and Answer Session

- a. How will the bid alternates be awarded?
  - i. Alternates will be awarded based on the combination of base plus add alternate sections that will allow the most work to be completed within the Owner's budget. The award of add alternates will be selected in accordance with the following priorities:
    - Base
    - Base + Add Alt. A
    - Base + Add Alt. A + Add Alt. B
    - Base + Add Alt. A + Add Alt. B + Add Alt. C
  - ii. Refer to JSP 5 – ADD ALTERNATES for more information
- b. Will the construction budget be made available after bids have been opened
  - i. Yes

10. Closing Remarks

- It was reiterated that there are two federal funding sources on the project: TAP and ARPA
  - Normal federal processes should be followed for typical LPA projects with additional requirements for ARPA compliance

"General Decision Number: MO20240001 11/22/2024

Superseded General Decision Number: MO20230001

State: Missouri

Construction Types: Heavy and Highway

Counties: Missouri Statewide.

HEAVY AND HIGHWAY CONSTRUCTION PROJECTS

Note: Contracts subject to the Davis-Bacon Act are generally required to pay at least the applicable minimum wage rate required under Executive Order 14026 or Executive Order 13658. Please note that these Executive Orders apply to covered contracts entered into by the federal government that are subject to the Davis-Bacon Act itself, but do not apply to contracts subject only to the Davis-Bacon Related Acts, including those set forth at 29 CFR 5.1(a)(1).

<p>If the contract is entered into on or after January 30, 2022, or the contract is renewed or extended (e.g., an option is exercised) on or after January 30, 2022:</p>	<ul style="list-style-type: none"> <li>. Executive Order 14026 generally applies to the contract.</li> <li>. The contractor must pay all covered workers at least \$17.20 per hour (or the applicable wage rate listed on this wage determination, if it is higher) for all hours spent performing on the contract in 2024.</li> </ul>
<p>If the contract was awarded on or between January 1, 2015 and January 29, 2022, and the contract is not renewed or extended on or after January 30, 2022:</p>	<ul style="list-style-type: none"> <li>. Executive Order 13658 generally applies to the contract.</li> <li>. The contractor must pay all covered workers at least \$12.90 per hour (or the applicable wage rate listed on this wage determination, if it is higher) for all hours spent performing on that contract in 2024.</li> </ul>

The applicable Executive Order minimum wage rate will be adjusted annually. If this contract is covered by one of the Executive Orders and a classification considered necessary for performance of work on the contract does not appear on this wage determination, the contractor must still submit a conformance request.

Additional information on contractor requirements and worker protections under the Executive Orders is available at <http://www.dol.gov/whd/govcontracts>.

Modification Number	Publication Date
0	01/05/2024
1	01/19/2024
2	02/23/2024



3	03/08/2024
4	04/19/2024
5	05/24/2024
6	07/05/2024
7	07/12/2024
8	08/02/2024
9	08/09/2024
10	08/30/2024
11	10/11/2024
12	10/18/2024
13	11/08/2024
14	11/22/2024

CARP0002-002 05/01/2023

ST. LOUIS COUNTY AND CITY

	Rates	Fringes
Carpenters.....	\$ 40.34	21.25

CARP0005-006 05/01/2023

CASS (Richards-Gebauer AFB ONLY), CLAY, JACKSON, PLATTE AND RAY COUNTIES

	Rates	Fringes
Carpenters:		
CARPENTERS & LATHERS.....	\$ 43.28	21.25
MILLWRIGHTS & PILEDRIVERS...	\$ 43.28	21.25

CARP0011-001 05/01/2023

	Rates	Fringes
Carpenter and Piledriver		
ADAIR, AUDRAIN (West of Hwy 19), BOONE, CALLAWAY, CHARITON, COLE, COOPER, HOWARD, KNOX, LINN, MACON, MILLER, MONITEAU, MONROE, OSAGE, PUTNAM, RANDOLPH, SCHUYLER, SHELBY AND SULLIVAN COUNTIES.....	\$ 34.31	21.25
ATCHISON, ANDREW, BATES, CALDWELL, CARROLL, DAVIESS, DEKALB, GENTRY, GRUNDY, HARRISON, HENRY, HOLT, LIVINGSTON, MERCER, NODAWAY, ST. CLAIR, SALINE AND WORTH COUNTIES.....	\$ 32.64	21.25
AUDRAIN (East of Hwy.19), RALLS, MARION, LEWIS, CLARK AND SCOTLAND COUNTIES..	\$ 34.31	21.25
BARRY, BARTON, CAMDEN, CEDAR, CHRISTIAN, DADE, DALLAS, DOUGLAS, GREENE, HICKORY, JASPER, LACLEDE, LAWRENCE, MCDONALD, NEWTON, OZARK, POLK, STONE, TANEY, VERNON, WEBSTER AND WRIGHT COUNTIES..	\$ 32.20	21.25
BENTON, MORGAN AND PETTIS...	\$ 32.69	21.25

BOLLINGER, BUTLER, CAPE		
GIRARDEAU, DUNKLIN,		
MISSISSIPPI, NEW MADRID,		
PEMISCOT, PERRY, STE.		
GENEVIEVE, SCOTT, STODDARD		
AND WAYNE COUNTIES.....\$	34.15	21.25
BUCHANAN, CLINTON, JOHNSON		
AND LAFAYETTE COUNTIES.....\$	33.43	21.25
CARTER, HOWELL, OREGON AND		
RIPLEY COUNTIES.....\$	32.99	21.25
CRAWFORD, DENT, GASCONADE,		
IRON, MADISON, MARIES,		
MONTGOMERY, PHELPS,		
PULASKI, REYNOLDS, SHANNON		
AND TEXAS COUNTIES.....\$	34.14	21.25
FRANKLIN COUNTY.....\$	37.93	21.25
JEFFERSON AND ST. CHARLES		
COUNTIES.....\$	40.34	21.25
LINCOLN COUNTY.....\$	36.21	21.25
PIKE, ST. FRANCOIS AND		
WASHINGTON COUNTIES.....\$	35.01	21.25
WARREN COUNTY.....\$	36.69	21.25

-----  
ELEC0001-002 06/02/2024

BOLLINGER, BUTLER, CAPE GIRARDEAU, CARTER, DUNKLIN, FRANKLIN,  
IRON, JEFFERSON, LINCOLN, MADISON, MISSISSIPPI, NEW MADRID,  
PEMISCOT, PERRY,REYNOLDS, RIPLEY, ST. CHARLES, ST. FRANCOIS,  
ST. LOUIS (City and County), STE. GENEVIEVE, SCOTT, STODDARD,  
WARREN, WASHINGTON AND WAYNE COUNTIES

	Rates	Fringes
Electricians.....\$	47.04	18.196

-----  
ELEC0002-001 09/04/2022

ADAIR, AUDRAIN, BOONE, CALLAWAY, CAMDEN, CARTER, CHARITON,  
CLARK, COLE, COOPER, CRAWFORD, DENT, FRANKLIN, GASCONADE,  
HOWARD, HOWELL, IRON, JEFFERSON, KNOX, LEWIS, LINCON, LINN,  
MACON, MARIES, MARION, MILLER, MONITEAU, MONROE, MONTGOMERY,  
MORGAN, OREGON, OSAGE, PERRY, PHELPS, PIKE, PULASKI, PUTNAM,  
RALLS, RANDOLPH, REYNOLDS, RIPLEY, ST. CHARLES, ST. FRANCOIS,  
ST. LOUIS (City and County), STE. GENEVIEVE, SCHUYLER,  
SCOTLAND, SHANNON, SHELBY, SULLIVAN, TEXAS, WARREN AND  
WASHINGTON COUNTIES

	Rates	Fringes
Line Construction:		
Equipment Operator.....\$	44.16	23.14
Groundman & Truck Driver....\$	33.74	19.34
Lineman & Cable Splicer.....\$	51.45	25.81

-----  
ELEC0053-004 01/01/2024

	Rates	Fringes
Line Construction: (ANDREW,		
ATCHINSON, BARRY, BARTON,		
BUCHANAN, CALDWELL, CEDAR,		
CHRISTIAN, CLINTON, DADE,		
DALLAS, DAVIES,, DEKALB,		

DOUGLAS, GENTRY, GREENE,  
GRUNDY, HARRISON, HICKORY,  
HOLT, JASPER, LACLEDE,  
LAWRENCE, LIVINGSTON,  
MCDONALD, MERCER, NEWTON,  
NODAWAY, OZARK, POLK, ST.  
CLAIR, STONE, TANEY, VERNON,  
WEBSTER, WORTH AND WRIGHT  
COUNTIES)

Groundman Powderman.....	\$ 35.71	1.5%+9.04
Groundman.....	\$ 32.32	1.5%+18.25
Lineman Operator.....	\$ 48.73	1.5%+23.33
Lineman.....	\$ 54.02	1.5%+25.08

Line Construction; (BATES,  
BENTON, CARROLL, CASS, CLAY,  
HENRY, JACKSON, JOHNSON,  
LAFAYETTE, PETTIS, PLATTE,  
RAY AND SALINE COUNTIES)

Groundman Powderman.....	\$ 33.58	18.34
Groundman.....	\$ 31.33	17.60
Lineman Operator.....	\$ 45.60	22.48
Lineman.....	\$ 50.31	24.11

-----  
ELEC0095-001 06/01/2024

BARRY, BARTON, CEDAR, DADE, JASPER, LAWRENCE, MCDONALD, NEWTON,  
ST CLAIR, AND VERNON COUNTIES

Rates Fringes

Electricians:

Cable Splicers.....	\$ 25.40	12.19
Electricians.....	\$ 31.09	8%+18.04

-----  
ELEC0124-007 08/28/2023

BATES, BENTON, CARROLL, CASS, CLAY, COOPER, HENRY, JACKSON,  
JOHNSON, LAFAYETTE, MORGAN, PETTIS, PLATTE, RAY AND SALINE  
COUNTIES:

Rates Fringes

Electricians.....	\$ 47.37	25.89
-------------------	----------	-------

-----  
ELEC0257-003 03/01/2024

AUDRAIN (Except Cuivre Township), BOONE, CALLAWAY, CAMDEN,  
CHARITON, COLE, CRAWFORD, DENT, GASCONADE, HOWARD, MARIES,  
MILLER, MONITEAU, OSAGE, PHELPS AND RANDOLPH COUNTIES

Rates Fringes

Electricians:

Cable Splicers.....	\$ 30.42	16.085
Electricians.....	\$ 38.50	17.515

-----  
ELEC0350-002 12/01/2023

ADAIR, AUDRAIN (East of Highway 19), CLARK, KNOX, LEWIS, LINN,  
MACON, MARION, MONROE, MONTGOMERY, PIKE, PUTNAM, RALLS,  
SCHUYLER, SCOTLAND, SHELBY AND SULLIVAN COUNTIES

	Rates	Fringes
Electricians.....	\$ 36.60	20.96

-----  
ELEC0453-001 09/01/2023

	Rates	Fringes
Electricians:		
CHRISITAN, DALLAS,		
DOUGLAS, GREENE, HICKORY,		
HOWELL, LACLEDE, OREGON,		
OZARK, POLK, SHANNON,		
WEBSTER and WRIGHT COUNTIES..	\$ 36.08	17.91
PULASKI and TEXAS COUNTIES..	\$ 36.08	17.91
STONE and TANEY COUNTIES....	\$ 26.62	17.11

-----  
ELEC0545-003 06/01/2024

ANDREW, BUCHANAN, CLINTON, DEKALB, ATCHISON, HOLT, MERCER,  
GENTRY, HARRISON, DAVIESS, GRUNDY, WORTH, LIVINGSTON, NODAWAY,  
AND CALDWELL COUNTIES

	Rates	Fringes
Electricians:.....	\$ 39.61	20.59

-----  
ELEC0702-004 01/01/2024

BOLLINGER, BUTLER, CAPE GIRARDEAU, DUNKLIN, MADISON,  
MISSISSIPPI, NEW MADRID, PEMISCOT, SCOTT, STODDARD AND WAYNE  
COUNTIES

	Rates	Fringes
Line Construction:		
Groundman - Class A.....	\$ 36.89	30%+8.60
Groundman-Equipment		
Operator Class II (all		
other equipment).....	\$ 44.92	30%+8.60
Heavy-Equipment Operator		
Class I (all crawler type		
equipment D-4 and larger)...	\$ 50.37	30%+8.60
Lineman.....	\$ 63.30	30%+8.60

-----  
ENGI0101-001 05/01/2020

ANDREW, ATCHISON, BATES, BENTON, BUCHANAN, CALDWELL, CARROLL,  
CHARITON, CLINTON, COOPER, DAVIESS, DEKALB, GENTRY, GRUNDY,  
HARRISON, HENRY, HOLT, HOWARD, JOHNSON, LAFAYETTE, LINN,  
LIVINGSTON, MERCER, NODAWAY, PETTIS, SALINE, SULLIVAN AND WORTH  
COUNITIES

	Rates	Fringes
Power equipment operators:		
GROUP 1.....	\$ 34.73	18.20
GROUP 2.....	\$ 34.33	18.20
GROUP 3.....	\$ 32.33	18.20

POWER EQUIPMENT OPERATORS CLASSIFICATIONS

GROUP 1: Asphalt roller operator, finish; asphalt paver and spreader; asphalt plant operator; auto grader or trimmer or sub-grader; backhoe; blade operator (all types); boilers - 2; booster pump on dredge; bulldozer operator; boring machine (truck or crane mounted); clamshell operator; concrete mixer paver; concrete plant operator; concrete pump operator; crane operator; derrick or derrick trucks; ditching machine; dragline operator; dredge engineman; dredge operator; drill cat with compressor mounted (self-contained) or similar type self-propelled rotary drill (not air tract); drilling or boring machine (rotary-self-propelled); finishing machine operator; greaser; high loader-fork lift-skid loader (all types); hoisting engineer (2 active drums); locomotive operator (standard gauge); mechanics and welders (field and plants); mucking machine operator; pile drive operator; pitman crane or boom truck (all types); push cat; quad track; scraper operators (all types); shovel operator; sideboom cats; side discharge spreader; skimmer scoop operators; slip form paver operator (CMI, Rex, Gomeco or equal); la tourneau rooter (all tiller types); tow boat operator; truck crane; wood and log chippers (all types).

GROUP 2: A-frame truck operator; articulated dump truck; back filler operator; boilers (1); chip spreader; churn drill operator; compressor; concrete mixer operator, skip loader; concrete saws (self-propelled); conveyor operator; crusher operator; distributor operator; elevating grader operator; farm tractor (all attachments); fireman rig; float operator; form grade operator; hoisting engine (one drum); maintenance operator; multiple compactor; pavement breaker, self-propelled hydra-hammer (or similar type); paymill operator; power shield; pumps; roller operator (with or without blades); screening and washing plant; self-propelled street broom or sweeper; siphons and jets; straw blower; stump cutting machine; siphons and jets; tank car heater operator (combination boiler and booster); welding machine; vibrating machine operator (not hand held); welding machine.

GROUP 3: (a) Oiler;  
                   (b) Oiler driver  
                   (c) Mechanic.

#### HOURLY PREMIUMS:

THE FOLLOWING CLASSIFICATIONS SHALL RECEIVE (\$ .25) ABOVE GROUP 1 RATE: Dragline operator - 3 yds. & over; shovel 3 yds. & over; clamshell 3 yds. & over; Crane, rigs or piledrivers, 100' of boom or over (incl. jib.), hoist - each additional active drum over 2 drums

THE FOLLOWING CLASSIFICATIONS SHALL RECEIVE (\$ .50) ABOVE GROUP 1 RATE: Tandem scoop operator; crane, rigs or piledrivers 150' to 200' of boom (incl. jib.)

THE FOLLOWING CLASSIFICATIONS SHALL RECEIVE (\$ .75) ABOVE GROUP 1 RATE: Crane rigs, or piledrivers 200 ft. of boom or over (including jib.)

-----  
 ENGI0101-005 04/01/2022

CASS, CLAY, JACKSON, PLATTE AND RAY COUNTIES

Rates Fringes

Power equipment operators:

GROUP 1.....	\$ 38.42	20.44
GROUP 2.....	\$ 37.38	20.44
GROUP 3.....	\$ 32.91	20.44
GROUP 4.....	\$ 36.26	20.44

POWER EQUIPMENT OPERATORS CLASSIFICATIONS

GROUP 1: Asphalt roller operator, finish; asphalt paver and spreader; asphalt plant operator; auto grader or trimmer or sub-grader; backhoe; blade operator (all types); boilers-2; booster pump on dredge; boring machine (truck or crane mounted); bulldozer operator; clamshell operator; concrete cleaning decontamination machine operator; concrete mixer paver; concrete plant operator; concrete pump operator; crane operator; derrick or derrick trucks; ditching machine; dragline operator; dredge engineman; dredge operator; drillcat with compressor mounted (self-contained) or similar type self propelled rotary drill (not air tract); drilling or boring machine (rotary - self-propelled); finishing machine operator; greaser; heavy equipment robotics operator/mechanic; horizontal directional drill operator; horizontal directional drill locator; loader-forklift - skid loader (all types); hoisting engineer (2 active drums); locomotive operator (standard guage); master environmental maintenance mechanic; mechanics and welders (field and plants); mucking machine operator; piledrive operator; pitman crane or boom truck (all types); push cat; quad-track; scraper operators (all types); shovel operator; side discharge spreader; sideboom cats; skimmer scoop operator; slip-form paver (CMI, REX, Gomaco or equal); la tourneau rooter (all tiller types); tow boat operator; truck crane; ultra high perssure waterjet cutting tool system operator/mechanic; vacuum blasting machine operator/mechanic; wood and log chippers (all types)

GROUP 2: ""A"" Frame truck operator; back filler operator; boilers (1); chip spreader;churn drill operator; concrete mixer operator, skip loader; concrete saws (self-propelled); conveyor operator; crusher operator; distributor operator; elevating grader operator; farm tractor (all attachments); fireman rig; float operator; form grader operator; hoisting engine (1 drum); maintenance operator; multiple compactor; pavement breaker, self-propelled hydra- hammer (or similar type); power shield; paymill operator; pumps; siphons and jets; stump cutting machine; tank car heater operator (combination boiler and booster); compressor; roller operator (with or without blades); screening and washing plant; self-propelled street broom or sweeper; straw blower; tank car heater operator (combination boiler and booster); vibrating machine operator (not hand held)

GROUP 3: Oilers

GROUP 4: Oiler Driver (All Types)

FOOTNOTE:

HOURLY PREMIUMS FOLLOWING CLASSIFICATIONS SHALL RECEIVE (\$1.00) ABOVE GROUP 1 RATE:  
 Clamshells - 3 yd. capacity or over; Cranes or rigs, 80 ft. of boom or over (including jib); Draglines, 3 yd. capacity

or over;  
Piledrivers 80 ft. of boom or over (including jib);  
Shovels & backhoes, 3 yd. capacity or over.

-----  
ENGI0101-022 05/01/2019

BARRY, BARTON, CAMDEN, CEDAR, CHRISTIAN, DADE, DALLAS, DOUGLAS,  
GREENE, HICKORY, JASPER, LACLEDE, LAWRENCE, MCDONALD, NEWTON,  
OZARK, POLK, ST. CLAIR, STONE, TANEY, VERNON, WEBSTER AND  
WRIGHT COUNTIES and CITY OF SPRINGFIELD

	Rates	Fringes
Power equipment operators:		
GROUP 1.....	\$ 31.72	14.88
GROUP 2.....	\$ 31.37	14.88
GROUP 3.....	\$ 31.17	14.88
GROUP 4.....	\$ 29.12	14.88

POWER EQUIPMENT OPERATORS CLASSIFICATIONS

GROUP 1: Asphalt finishing machine & trench widening spreader; asphalt plant console operator; autograder; automatic slipform paver; backhoe; blade operator - all types; boat operator - tow; boilers-2; central mix concrete plant operator; clamshell operator; concrete mixer paver; crane operator; derrick or derrick trucks; ditching machine; dozer operator; dragline operator; dredge booster pump; dredge engineman; dredge operator; drill cat with compressor mounted on cat; drilling or boring machine rotary self-propelled; highloader; hoisting engine - 2 active drums; launch hammer wheel; locomotive operator; - standard guage; mechanic and welders; mucking machine; off-road trucks; piledriver operator; pitman crane operator; push cat operator; quad trac; scoop operator - all types; shovel operator; sideboom cats; skimmer scoop operators; trenching machine operator; truck crane.

GROUP 2: A-frame; asphalt hot-mix silo; asphalt plant fireman (drum or boiler); asphalt plant man; asphalt plant man; asphalt plant mixer operator; asphalt roller operator; backfiller operator; barber-greene loader; boat operator (bridges and dams); chip spreader; concrete mixer operator - skip loader; concrete plant operator; concrete pump operator; crusher operator; dredge oiler; elevating grader operator; fork lift; greaser-fleet; hoisting engine - 1; locomotive operator - narrow gauge; multiple compactor; pavement breaker; powerbroom - self-propelled; power shield; rooter; side discharge concrete spreader; slip form finishing machine; stumpcutter machine; throttle man; tractor operator (over 50 h.p.); winch truck.

GROUP 3: Boilers - 1; chip spreader (front man); churn drill operator; clef plane operator; concrete saw operator (self-propelled); curb finishing machine; distributor operator; finishing machine operator; flex plane operator; float operator; form grader operator; pugmill operator; roller operator, other than high type asphalt; screening & washing plant operator; siphons & jets; sub-grading machine operator; spreader box operator, self-propelled (not asphalt); tank car heater operator (combination boiler & booster); tractor operator (50 h.p. or less); Umac, Ulric or similar spreader; vibrating machine operator, not hand;

GROUP 4: Grade checker; Oiler; Oiler-Driver

HOURLY PREMIUMS:

The following classifications shall receive \$ .25 above GROUP 1 rate:

- Clamshells - 3 yds. or over; Cranes - Rigs or Piledrivers, 100 ft. of boom or over (including jib);
- Draglines - 3 yds. or over; Hoists - each additional active drum over 2 drums; Shovels - 3 yds. or over;

The following classifications shall receive \$ .50 above GROUP 1 rate:

- Tandem scoop operator; Cranes - Rigs or Piledrivers, 150 ft. to 200 ft. of boom (including jib); Tandem scoop.

The following classifications shall receive \$ .75 above GROUP 1 rate:

- Cranes - Rigs or Piledrivers, 200 ft. of boom or over (including jib.).

-----  
ENGI0513-004 05/06/2024

FRANKLIN, JEFFERSON, LINCOLN, ST CHARLES, AND WARREN COUNTIES

	Rates	Fringes
Power equipment operators:		
GROUP 1.....	\$ 43.46	30.22
GROUP 2.....	\$ 43.46	30.22
GROUP 3.....	\$ 42.16	30.22
GROUP 4.....	\$ 41.72	30.22

POWER EQUIPMENT OPERATORS CLASSIFICATIONS

GROUP 1: Backhoe, Cable; Backhoe, Hydraulic (2 cu yds bucket and under regardless of attachment, one oiler for 2 or 3, two oilers for 4 through 6); Backhoe, Hydraulic over 2 cu yds; Cableway; Crane, Crawler or Truck; Crane, Hydraulic - Truck or Cruiser mounted, 16 tons and over; Crane, Locomotive; crane with boom including jib over 100 ft from pin to pin; Crane using rock socket tool; Derrick, Steam; Derrick Car and Derrick Boat; Dragline, 7 cu yds and over; Dredge; Gradall, Crawler or tire mounted; Locomotive, Gas, Steam & other powers; Pile Driver, Land or Floating; Scoop, Skimmer; Shovel, Power (Electric, Gas, Steam or other powers); Shovel, Power (7 cu yds and over); Switch Boat; Whirley; Air Tugger with air compressor; Anchor Placing Barge; Asphalt Spreaker; Athey Force Feeder Loader, self-propelled; Backfilling Machine; Boat Operator - Push Boat or Tow Boat (job site); Boiler, High Pressure Breaking in Period; Boom Truck, Placing or Erecting; Boring Machine, Footing Foundation; Bullfloat; Cherry Picker; Combination Concrete Hoist and Mixer (such as Mixermobile); Compressor, Two 125 CFM and under; Compressor, Two through Four over 125 CFM; Compressor when operator runs throttle; Concrete Breaker (Truck or Tractor mounted); Concrete Pump (such as Pumpcrete machine); Concrete Saw (self-propelled); Concrete Spreader; Conveyor, Large (not selfpropelled) hoisting or moving brick and concrete into, or into and on floor level, one or both; Crane, Cimbing (such as Linden); Crane, Hydraulic - Rough Terrain, self-propelled; Crane, Hydraulic - Truck or Cruiser mounted - under 16 tons; Drilling



machine - Self-powered, used for earth or rock drilling or boring (wagon drills and any hand drills obtaining power from other sources including concrete breakers, jackhammers and Barco equipment no engineer required); Elevating Grader; Engine Man, Dredge; Excavator or Powerbelt Machine; Finishing Machine, self-propelled oscillating screed; Forklift; Generators, Two through Six 30 KW or over; Grader, Road with power blade; Greaser; Highlift; Hoist, Concrete and Brick (Brick cages or concrete skips operating on tower, Towermobile, or similar equipment); Hoist, Three or more drums in use; Hoist, Stack; Hydro-Hammer; Lad-A-Vator, hoisting brick or concrete; Loading Machine such as Barber-Greene; Mechanic on job site

GROUP 2: Air Tugger with plant air; Boiler (for power or heating shell of building or temporary enclosures in connection with construction work); Boiler, Temporary; Compressor, One over 125 CFM; Compressor, truck mounted; Conveyor, Large (not self-propelled); Conveyor, Large (not self-propelled) moving brick and concrete (distributing) on floor level; Curb Finishing Machine; Ditch Paving Machine; Elevator (outside); Endless Chain Hoist; Fireman (as required); Form Grader; Hoist, One Drum regardless of size (except brick or concrete); Lad-A-Vator, other hoisting; Manlift; Mixer, Asphalt, over 8 cu ft capacity; Mixer, one bag capacity or less; Mixer, without side loader, two bag capacity or more; Mixer, with side loader, regardless of size, not Paver; Mud Jack (where mud jack is used in conjunction with an air compressor, operator shall be paid \$ .55 per hour in addition to his basic hourly rate for covering both operations); Pug Mill operator; Pump, Sump - self powered, automatic controlled over 2"; Scissor Lift (used for hoisting); Skid Steer Loader; Sweeper, Street; Tractor, small wheel type 50 HP and under with grader blade and similar equipment; Welding Machine, One over 400 amp; Winch, operating from truck

GROUP 3: Boat operator - outboard motor, job site; Conveyors (such as Con-Vay-It) regardless of how used; Elevator (inside); Heater operator, 2 through 6; Sweeper, Floor

GROUP 4: Crane type

#### HOURLY PREMIUMS:

Backhoe, Hydraulic 2 cu yds or less without oiler - \$2.00;  
 Crane, climbing (such as Linden) - \$.50;  
 Crane, Pile Driving and Extracting - \$ .50  
 Crane with boom (including job) over  
 100 ft from pin to pin - add \$.01 per foot  
 to maximum of \$4.00);  
 Crane, using rock socket tool - \$ .50;  
 Derrick, diesel, gas or electric hoisting material  
 and erecting steel (150 ft or more above ground) - \$ .50;  
 Dragline, 7 cu yds and over - \$ .50;  
 Hoist, Three or more drums in use - \$ .50;  
 Scoop, Tandem - \$.50;  
 Shovel, Power - 7 cu yds and over - \$ .50;  
 Tractor, Tandem Crawler - \$ .50;  
 Tunnel, man assigned to work in tunnel or  
 tunnel shaft - \$ .50;  
 Wrecking, when machines are working on  
 second floor or higher - \$ .50

ENGI0513-006 05/06/2024

ADAIR, AUDRAIN, BOLLINGER, BOONE, BUTLER, CALLAWAY, CAPE GIRARDEAU, CARTER, CLARK, COLE, CRAWFORD, DENT, DUNKLIN, GASCONADE, HOWELL, IRON, KNOX, LEWIS, MACON, MADISON, MARIES, MARION, MILLER, MISSISSIPPI, MONITEAU, MONROE, MONTGOMERY, MORGAN, NEW MADRID, OREGON, OSAGE, PEMISCOT, PERRY, PHELPS, PIKE, PULASKI, PUTNAM, RALLS, RANDOLPH, REYNOLDS, RIPLEY, ST. FRANCOIS, STE. GENEVIEVE, SCHUYLER, SCOTLAND, SCOTT, SHANNON, SHELBY, STODDARD, TEXAS, WASHINGTON, AND WAYNE COUNTIES

	Rates	Fringes
Power equipment operators:		
GROUP 1.....	\$ 43.46	30.22
GROUP 2.....	\$ 43.46	30.22
GROUP 3.....	\$ 42.16	30.22
GROUP 4.....	\$ 41.72	30.22

POWER EQUIPMENT OPERATORS CLASSIFICATIONS

GROUP 1: Asphalt finishing machine & trench widening spreader, asphalt plant console operator; autograder; automatic slipform paver; back hoe; blade operator - all types; boat operator tow; boiler two; central mix concrete plant operator; clam shell operator; concrete mixer paver; crane operator; derrick or derrick trucks; ditching machine; dozer operator; dragline operator; dredge booster pump; dredge engineman; dredge operator; drill cat with compressor mounted on cat; drilling or boring machine rotary self-propelled; highloader; hoisting engine 2 active drums; launchhammer wheel; locomotive operator standrad guage; mechanics and welders; mucking machine; piledriver operator; pitman crane operator; push cat operator; guad-trac; scoop operator; sideboom cats; skimmer scoop operator; trenching machine operator; truck crane, shovel operator.

GROUP 2: A-Frame; asphalt hot-mix silo; asphalt roller operator asphalt plant fireman (drum or boiler); asphalt plant man; asphalt plant mixer operator; backfiller operator; barber-greene loader; boat operator (bridge & dams); chip spreader; concrete mixer operator skip loader; concrete plant operator; concrete pump operator; dredge oiler; elevating graded operator; fork lift; grease fleet; hoisting engine one; locomotive operator narrow guage; multiple compactor; pavement breaker; powerbroom self-propelled; power shield; rooter; slip-form finishing machine; stumpcutter machine; side discharge concrete spreader; throttlemann; tractor operator (over 50 hp); winch truck; asphalt roller operator; crusher operator.

GROUP 3: Spreader box operator, self-propelled not asphalt; tractor operator (50 h.p. or less); boilers one; chip spreader (front man); churn drill operator; compressor over 105 CFM 2-3 pumps 4" & over; 2-3 light plant 7.5 KWA or any combination thereof; clef plane operator; compressor maintenance operator 2 or 3; concrete saw operator (self-propelled); curb finishing mancine; distributor operator; finishing machine operator; flex plane operator; float operator; form grader operator; pugmill operator; riller operator other than high type asphalt; screening & washing plant operator; siphons & jets; subgrading machine operator; tank car heater (combination boiler & booster);

ulmac, ulric or similar spreader; vibrating machine operator; hydrobroom.

GROUP 4: Oiler; grout machine; oiler driver; compressor over 105 CFM one; conveyor operator one; maintenance operator; pump 4" & over one.

FOOTNOTE: HOURLY PREMIUMS

- Backhoe hydraulic, 2 cu. yds. or under Without oiler - \$2.00
- Certified Crane Operator - \$1.50;
- Certified Hazardous Material Operator \$1.50;
- Crane, climbing (such as Linden) - \$0.50;
- Crane, pile driving and extracting - \$0.50;
- Crane, with boom (including jib) over 100' from pin to pin add \$0.01 per foot to maximum of \$4.00;
- Crane, using rock socket tool - \$0.50;
- Derrick, diesel, gas or electric, hoisting material and erecting steel (150' or more above the ground) - \$0.50;
- Dragline, 7 cu. yds, and over - \$0.50;
- Hoist, three or more drums in use - \$0.50; Scoop, Tandem - \$0.50;
- Shovel, power - 7 cu. yds. or more - \$0.50;
- Tractor, tandem crawler - \$0.50;
- Tunnel, man assigned to work in tunnel or tunnel shaft - \$0.50;
- Wrecking, when machine is working on second floor or higher - \$0.50;

-----  
ENGI0513-007 05/06/2024

ST. LOUIS CITY AND COUNTY

	Rates	Fringes
Power equipment operators:		
GROUP 1.....	\$ 43.46	30.22
GROUP 2.....	\$ 43.46	30.22
GROUP 3.....	\$ 42.16	30.22
GROUP 4.....	\$ 41.72	30.22

POWER EQUIPMENT OPERATORS CLASSIFICATIONS

GROUP 1: Backhoe, cable or hydraulic; cableway; crane crawler or truck; crane, hydraulic-truck or cruiser mounted 16 tons & over; crane locomotive; derrick, steam; derrick car & derrick boat; dragline; dredge; gradall, crawler or tire mounted; locomotive, gas, steam & other powers; pile driver, land or floating; scoop, skimmer; shovel, power (steam, gas, electric or other powers); switch boat; whirley.

GROUP 2: Air tugger w/air compressor; anchor-placing barge; asphalt spreader; atehy force feeder loader (self-propelled); backfilling machine; backhoe-loader; boat operator-push boat or tow boat (job site); boiler, high pressure breaking in period; boom truck, placing or erecting; boring machine, footing foundation; bull- float; cherry picker; combination concrete hoist & mixer (such as mixer mobile); compressor (when operator runs throttle); concrete breaker (truck or tractor mounted); concrete pump, such as pump-crete machine; concrete saw (self-propelled), concrete spreader; conveyor, large (not self-propelled), hoisting or moving brick and concrete into, or into and on

floor level, one or both; crane, hydraulic-rough terrain, self-propelled; crane hydraulic-truck or cruiser mounted-under 16 tons; drilling machines, self-powered use for earth or rock drilling or boring (wagon drills and any hand drills obtaining power from other sources including concrete breakers, jackhammers and barco equipment-no engineer required); elevating grader; engineman, dredge; excavator or powerbelt machine; finishing machine, self-propelled oscillating screed; forklift; grader, road with power blade; highlift. greaser; hoist, stack, hydro-hammer; loading machine (such as barber-greene); machanic, on job site; mixer, pipe wrapping machines; plant asphalt; plant, concrete producing or ready-mix job site; plant heating-job site; plant mixing-job site; plant power, generating-job site; pumps, two through six self-powered over 2""; pumps, electric submersible, two through six, over 4""; quad-track; roller, asphalt, top or sub-grade; scoop, tractor drawn; spreader box; sub-grader; tie tamper; tractor-crawler, or wheel type with or without power unit, power take-offs and attachments regardless of size; trenching machine; tunnel boring machine; vibrating machine automatic, automatic propelled; welding machines (gasoline or diesel) two through six; well drilling machine

GROUP 3: Conveyor, large (not self-propelled); conveyor, large (not self-propelled) moving brick and concrete distributing) on floor level; mixer two or more mixers of one bag capacity or less; air tugger w/plant air; boiler, for power or heating on construction projects; boiler, temporary; compressor (mounted on truck; curb finishing machine; ditch paving machine; elevator; endless chain hoist; form grader; hoist, one drum regardless of size; lad-a-vator; manlift; mixer, asphalt, over 8 cu. ft. capacity, without side loader, 2 bag capacity or more; mixer, with side loader, regardless of size; pug mill operator; pump, sump-self-powered, automatic controlled over 2"" during use in connection with construction work; sweeper, street; welding machine, one over 400 amp.; winch operating from truck; scissor lift (used for hoisting); tractor, small wheel type 50 h.p. & under with grader blade & similar equipment; Oiler on dredge and on truck crane.

GROUP 4: Boat operator-outboard motor (job site); conveyor (such as con-vay-it) regardless of how used; sweeper, floor

#### HOURLY PREMIUMS:

Backhoe, hydraulic	
2 cu. yds. or under without oiler	\$2.00
Certified Crane Operator	1.50
Certified Hazardous Material Operator	1.50
Crane, climbing (such as Linden)	.50
Crane, pile driving and extracting	.50
Crane, with boom (including jib) over 100' (from pin to pin) add \$.01 per foot to maximum of	4.00
Crane, using rock socket tool	.50
Derrick, diesel, gas or electric, hoisting material and erecting steel (150' or more above ground)	.50
Dragline, 7 cu. yds. and over	.50
Hoist, three (3) or more drums in use	.50
Scoop, Tandem	.50
Shovel, power - 7 cu. yds. or more	.50
Tractor, tandem crawler	.50
Tunnel, man assigned to work in tunnel	

or tunnel shaft	.50
Wrecking, when machine is working on second floor or higher	.50

-----  
IRON0010-012 04/01/2024

	Rates	Fringes
--	-------	---------

Ironworkers:

ANDREW, BARTON, BENTON, CAMDEN, CEDAR, CHARITON, CHRISTIAN, COOPER, DADE, DALLAS, DAVIESS, DE KALB, GENTRY, GREENE, GRUNDY, HARRISON, HICKORY, HOLT, HOWARD, LACLEDE, LINN, LIVINGSTON, MERCER, MONITEAU, MORGAN, NODAWAY, PETTIS, POLK, PUTNAM, RANDLOPH, ST. CLAIR, SULLIVAN, TANEY, VERNON, WEBSTER, WRIGHT and WORTH Counties and portions of ADAIR, BOONE, MACON, MILLER and RANDOLPH Counties.....	\$ 35.00	33.56
ATCHISON, BATES, BUCHANAN, CALDWELL, CARROLL, CASS, CLAY, CLINTON, HENRY, JACKSON, JOHNSON, LAFAYETTE, PETTIS, PLATTE, SALINE, AND RAY COUNTIES....	\$ 38.00	33.56

-----  
IRON0321-002 08/01/2023

DOUGLAS, HOWELL and OZARK COUNTIES

	Rates	Fringes
--	-------	---------

Ironworker.....	\$ 27.00	20.96
-----------------	----------	-------

-----  
IRON0396-004 08/07/2024

ST. LOUIS (City and County), ST. CHARLES, JEFFERSON, IRON, FRANKLIN, LINCOLN, WARREN, WASHINGTON, ST. FRANCOIS, STE. GENEVIEVE, and REYNOLDS Counties; and portions of MADISON, PERRY, BOLLINGER, WAYNE, and CARTER Counties

	Rates	Fringes
--	-------	---------

Ironworker.....	\$ 41.67	31.25
-----------------	----------	-------

-----  
IRON0396-009 08/07/2024

AUDRAIN, CALLAWAY, COLE, CRAWFORD, DENT, GASCONADE, MARIES, MONTGOMERY, OSAGE, PHELPS, PIKE, PULASKI, TEXAS and WRIGHT Counties; and portions of BOONE, CAMDEN, DOUGLAS, HOWELL, LACLEDE, MILLER, MONROE, OREGON, SHANNON and RALLS Counties

	Rates	Fringes
--	-------	---------

Ironworker.....	\$ 41.67	31.25
-----------------	----------	-------

\* IRON0577-005 06/01/2024

ADAIR, CLARK, KNOX, LEWIS, MACON, MARION, MONROE, RALLS, SCHUYLER, SCOTLAND, AND SHELBY COUNTIES

	Rates	Fringes
Ironworker.....	\$ 34.05	25.30

-----  
IRON0584-004 06/01/2023

BARRY, JASPER, LAWRENCE, MCDONALD, NEWTON AND STONE Counties

	Rates	Fringes
Ironworkers:.....	\$ 29.00	16.20

-----  
IRON0782-003 08/01/2023

CAPE GIRARDEAU, MISSISSIPPI, NEW MADRID, SCOTT, & STODDARD Counties; and portions of BOLLINGER, BUTLER, CARTER, DUNKLIN, MADISON, PEMISCOT, PERRY, RIPLEY, and WAYNE Counties

	Rates	Fringes
Ironworkers:		
Locks, Dams, Bridges and other major work on the Mississippi and Ohio River only.....	\$ 38.77	29.51
All Other Work.....	\$ 33.47	24.12

-----  
LAB00042-003 03/01/2023

ST. LOUIS (City and County)

	Rates	Fringes
LABORER		
Plumber Laborer.....	\$ 36.65	17.12

-----  
LAB00042-005 03/01/2023

ST. LOUIS (City and County)

	Rates	Fringes
LABORER		
Dynamiter, Powderman.....	\$ 36.65	17.12
Laborers, Flaggers.....	\$ 36.65	17.12
Wrecking.....	\$ 36.65	17.12

-----  
LAB00110-005 05/01/2023

Jefferson and Washington Counties

	Rates	Fringes
LABORER (Jefferson County)		
GROUP 1.....	\$ 35.49	15.62
GROUP 2.....	\$ 36.09	15.62
LABORER (Washington County)		

GROUP 1.....	\$ 32.98	15.62
GROUP 2.....	\$ 32.98	15.62

LABORERS CLASSIFICATIONS

GROUP 1 - General laborer-flagman, carpenter tenders; salamander Tenders; Dump Man; Ticket Takers; loading trucks under bins, hoppers, and conveyors; track man; cement handler; dump man on earth fill; georgie buggy man; material batch hopper man; spreader on asphalt machine; material mixer man (except on manholes); coffer dams; riprap pavers rock, block or brick; scaffolds over ten feet not self-supported from ground up; skip man on concrete paving; wire mesh setters on concrete paving; all work in connection with sewer, water, gas, gasoling, oil, drainage pipe, conduit pipe, tile and duct lines and all other pipe lines; power tool operator; all work in connection with hydraulic or general dredging operations; form setters, puddlers (paving only); straw blower nozzle man; asphalt plant platform man; chuck tender; crusher feeder; men handling creosote ties or creosote materials; men working with and handling epoxy material; topper of standing trees; feeder man on wood pulverizers, board and willow mat weavers and cabelee tiers on river work; deck hands; pile dike and revetment work; all laborers working on underground tunnels less than 25 ft. where compressed air is not used; abutment and pier hole men working six (6) ft. or more below ground; men working in coffer dams for bridge piers and footing in the river; barco tamper; jackson or any other similar tamp; cutting torch man; liners, curb, gutters, ditch lines; hot mastic kettlemen; hot tar applicator; hand blade operator; mortar men or brick or block manholes; rubbing concrete, air tool operator under 65 lbs.; caulker and lead man; chain or concrete saw under 15 h.p.; signal Gan; Guard rail and sign erectors.

GROUP 2 - Skilled laborers - Vibrator man; asphalt raker; head pipe layer on sewer work; batterboard man on pipe and ditch work; cliff scalers working from bosun's chairs; scaffolds or platforms on dams or power plants over 10 ft. high; air tool operator over 65 lbs.; stringline man on concrete paving; sandblast man; laser beam man; wagon drill; churn drill; air track drill and all other similar type drills, gunite nozzle man; pressure grout man; screed man on asphalt; concrete saw 15 h.p. and over; grade checker; strigline man on electronic grade control; manhole builder; dynamite man; powder man; welder; tunnel man; waterblaster - 1000 psi or over; asbestos and/or hazardous waste removal and/or disposal

-----  
LAB00579-005 05/01/2023

	Rates	Fringes
--	-------	---------

LABORER (ANDREW, ATCHISON, BUCHANAN, CALDWELL, CLINTON, DAVIESS, DEKALB, GENTRY, GRUNDY, HARRISON, HOLT, LIVINGSTON, MERCER, NODAWAY and WORTH COUNTIES.)

GROUP 1.....	\$ 29.04	16.59
GROUP 2.....	\$ 29.39	16.59

LABORER (BARRY, BARTON,

BATES, BENTON, CAMDEN,  
CARROLL, CEDAR, CHRISTIAN,  
DADE, DALLAS, DOUGLAS,  
GREENE, HENRY, HICKORY,  
JASPER, JOHNSON, LACLEDE,  
LAWRENCE, MCDONALD, MORGAN,  
NEWTON, OZARK, PETTIS, POLK,  
ST.CLAIR, SALINE, STONE,  
TANEY, VERNON, WEBSTER and  
WRIGHT COUNTIES)

GROUP 1.....	\$ 28.23	15.60
GROUP 2.....	\$ 28.78	15.60
LABORER (LAFAYETTE COUNTY)		
GROUP 1.....	\$ 29.78	15.85
GROUP 2.....	\$ 30.13	15.85

LABORERS CLASSIFICATIONS

GROUP 1: General Laborers - Carpenter tenders; salamander tenders; loading trucks under bins; hoppers & conveyors; track men & all other general laborers; air tool operator; cement handler-bulk or sack; dump man on earth fill; georgie buggy man; material batch hopper man; material mixer man (except on manholes); coffer dams; riprap pavers - rock, block or brick; signal man; scaffolds over ten feet not self-supported from ground up; skipman on concrete paving; wire mesh setters on concrete paving; all work in connection with sewer, water, gas, gasoline, oil drainage pipe, conduit pipe, tile and duct lines and all other pipe lines; power tool operator, all work in connection with hydraulic or general dredging operations; puddlers (paving only); straw blower nozzle man; asphalt plant platform man; chuck tender; crusher feeder; men handling creosote ties or creosote materials; men working with and handling epoxy material or materials (where special protection is required); rubbing concrete; topper of standing trees; batter board man on pipe and ditch work; feeder man on wood pulverizers; board and willow mat weavers and cable tiers on river work; deck hands; pile dike and revetment work; all laborers working on underground tunnels less than 25 feet where compressed air is not used; abutment and pier hole men working six (6) feet or more below ground; men working in coffer dams for bridge piers and footings in the river; ditchliners; pressure groutmen; caulker; chain or concrete saw; cliffscalers working from scaffolds, bosuns' chairs or platforms on dams or power plants over (10) feet above ground; mortarmen on brick or block manholes; toxic and hazardous waste work.

GROUP 2: Skilled Laborers - Head pipe layer on sewer work; laser beam man; Jackson or any other similar tamp; cutting torch man; form setters; liners and stringline men on concrete paving, curb, gutters; hot mastic kettleman; hot tar applicator; sandblasting and gunite nozzle men; air tool operator in tunnels; screed man on asphalt machine; asphalt raker; barco tamper; churn drills; air track drills and all similar drills; vibrator man; stringline man for electronic grade control; manhole builders-brick or block; dynamite and powder men; grade checker.

-----  
LAB00660-004 05/01/2023

Clark, Knox, Lewis, Marion, Pike, Ralls, Scotland, Shelby Counties



	Rates	Fringes
LABORER		
GROUP 1.....	\$ 32.98	15.62
GROUP 2.....	\$ 32.98	15.62

LABORERS CLASSIFICATIONS

GROUP 1 - General laborer-flagman, carpenter tenders; salamander Tenders; Dump Man; Ticket Takers; loading trucks under bins, hoppers, and conveyors; track man; cement handler; dump man on earth fill; georgie buggy man; material batch hopper man; spreader on asphalt machine; material mixer man (except on manholes); coffer dams; riprap pavers rock, block or brick; scaffolds over ten feet not self-supported from ground up; skip man on concrete paving; wire mesh setters on concrete paving; all work in connection with sewer, water, gas, gasoling, oil, drainage pipe, conduit pipe, tile and duct lines and all other pipe lines; power tool operator; all work in connection with hydraulic or general dredging operations; form setters, puddlers (paving only); straw blower nozzle man; asphalt plant platform man; chuck tender; crusher feeder; men handling creosote ties or creosote materials; men working with and handling epoxy material; topper of standing trees; feeder man on wood pulverizers, board and willow mat weavers and cabelee tiers on river work; deck hands; pile dike and revetment work; all laborers working on underground tunnels less than 25 ft. where compressed air is not used; abutement and pier hole men working six (6) ft. or more below ground; men working in coffer dams for bridge piers and footing in the river; barco tamper; jackson or any other similar tamp; cutting torch man; liners, curb, gutters, ditch lines; hot mastic kettlemen; hot tar applicator; hand blade operator; mortar men or brick or block manholes; rubbing concrete, air tool operator under 65 lbs.; caulker and lead man; chain or concrete saw under 15 h.p.; signal Gan; Guard rail and sign erectors.

GROUP 2 - Skilled laborers - Vibrator man; asphalt raker; head pipe layer on sewer work; batterboard man on pipe and ditch work; cliff scalers working from bosun's chairs; scaffolds or platforms on dams or power plants over 10 ft. high; air tool operator over 65 lbs.; stringline man on concrete paving; sandblast man; laser beam man; wagon drill; churn drill; air track drill and all other similar type drills, guniting nozzle man; pressure grout man; screed man on asphalt; concrete saw 15 h.p. and over; grade checker; strigline man on electronic grade control; manhole builder; dynamite man; powder man; welder; tunnel man; waterblaster - 1000 psi or over; asbestos and/or hazardous waste removal and/or disposal

-----  
 \* LAB00660-006 03/04/2024

Lincoln, Montgomery, St Charles and Warren Counties

	Rates	Fringes
LABORER (Common or General).....	\$ 36.91	15.62
Lincoln, Monntomery, and		

Warrner Counties.....	\$ 37.69	15.97
St. Charles County.....	\$ 39.11	15.97

-----  
LAB00662-001 05/01/2023

Callaway, Cole, Miller and Moniteau Counties

	Rates	Fringes
LABORER		
GROUP 1.....	\$ 32.98	15.62
GROUP 2.....	\$ 32.98	15.62

LABORERS CLASSIFICATIONS

GROUP 1 - General laborer-flagman, carpenter tenders; salamander Tenders; Dump Man; Ticket Takers; loading trucks under bins, hoppers, and conveyors; track man; cement handler; dump man on earth fill; georgie buggy man; material batch hopper man; spreader on asphalt machine; material mixer man (except on manholes); coffer dams; riprap pavers rock, block or brick; scaffolds over ten feet not self-supported from ground up; skip man on concrete paving; wire mesh setters on concrete paving; all work in connection with sewer, water, gas, gasoling, oil, drainage pipe, conduit pipe, tile and duct lines and all other pipe lines; power tool operator; all work in connection with hydraulic or general dredging operations; form setters, puddlers (paving only); straw blower nozzle man; asphalt plant platform man; chuck tender; crusher feeder; men handling creosote ties or creosote materials; men working with and handling epoxy material; topper of standing trees; feeder man on wood pulverizers, board and willow mat weavers and cabelee tiers on river work; deck hands; pile dike and revetment work; all laborers working on underground tunnels less than 25 ft. where compressed air is not used; abutement and pier hole men working six (6) ft. or more below ground; men working in coffer dams for bridge piers and footing in the river; barco tamper; jackson or any other similar tamp; cutting torch man; liners, curb, gutters, ditch lines; hot mastic kettlemen; hot tar applicator; hand blade operator; mortar men or brick or block manholes; rubbing concrete, air tool operator under 65 lbs.; caulker and lead man; chain or concrete saw under 15 h.p.; signal Gan; Guard rail and sign erectors.

GROUP 2 - Skilled laborers - Vibrator man; asphalt raker; head pipe layer on sewer work; batterboard man on pipe and ditch work; cliff scalers working from bosun's chairs; scaffolds or platforms on dams or power plants over 10 ft. high; air tool operator over 65 lbs.; stringline man on concrete paving; sandblast man; laser beam man; wagon drill; churn drill; air track drill and all other similar type drills, gunite nozzle man; pressure grout man; screed man on asphalt; concrete saw 15 h.p. and over; grade checker; strigline man on electronic grade control; manhole builder; dynamite man; powder man; welder; tunnel man; waterblaster - 1000 psi or over; asbestos and/or hazardous waste removal and/or disposal

-----  
LAB00663-002 04/01/2024

CASS, CLAY, JACKSON, PLATTE AND RAY COUNTIES

	Rates	Fringes
LABORER		
GROUP 1.....	\$ 35.24	15.57
GROUP 2.....	\$ 36.45	15.57

LABORERS CLASSIFICATIONS

GROUP 1: General laborers, Carpenter tenders, salamander tenders, loading trucks under bins, hoppers and conveyors, track men and all other general laborers, air tool operator, cement handler (bulk or sack), chain or concrete saw, deck hands, dump man on earth fill, Georgie Buggies man, material batch hopper man, scale man, material mixer man (except on manholes), coffer dams, abutments and pier hole men working below ground, riprap pavers rock, black or brick, signal man, scaffolds over ten feet not self-supported from ground up, skipman on concrete paving, wire mesh setters on concrete paving, all work in connection with sewer,water, gas, gasoling, oil, drainage pipe, conduit pipe, tile and duct lines and all other pipelines, power tool operator, all work in connection with hydraulic or general dredging operations, straw blower nozzleman,asphalt plant platform man, chuck tender, crusher feeder, men handling creosote ties on creosote materials, men working with and handling epoxy material or materials (where special protection is required), topper of standing trees, batter board man on pipe and ditch work, feeder man on wood pulverizers, board and willow mat weavers and cable tiers on river work, deck hands, pile dike and revetment work, all laborers working on underground tunnels less than 25 feet where compressed air is not used, abutment and pier hole men working six (6) feet or more below ground, men working in coffer dams for bridge piers and footings in the river, ditchliners, pressure groutmen, caulker and chain or concrete saw, cliffscalers working from scaffolds, bosuns' chairs or platforms on dams or power plants over (10) feet above ground, mortarmen on brick or block manholes, signal man.

GROUP 2: Skilled Laborer - spreader or screed man on asphalt machine, asphalt raker, grade checker, vibrator man, concrete saw over 5 hp., laser beam man, barco tamper, jackson or any other similar tamp, wagon driller, churn drills, air track drills and other similar drills, cutting torch man, form setters, liners and stringline men on concrete paving, curb, gutters and etc., hot mastic kettleman, hot tar applicator, hand blade operators, mortar men on brick or block manholes, sand blasting and gunnite nozzle men, rubbing concrete, air tool operator in tunnels, head pipe layer on sewer work, manhole builder (brick or block), dynamite and powder men.

-----  
LAB00840-011 05/01/2023

Crawford, Dent, Franklin, Gasconade, Howell, Maries, Oregon, Osage, Phelps, Pulaski, Shannon and Texas Counties

	Rates	Fringes
LABORER (Crawford, Dent, Gasconade, Howell, Maries,		

Oregon, Osage, Phelps,  
Pulaski, Shannon and Texas  
Counties)

GROUP 1.....	\$ 32.98	15.62
GROUP 2.....	\$ 32.98	15.62
LABORER (Franklin County)		
GROUP 1.....	\$ 35.44	15.62
GROUP 2.....	\$ 36.04	15.62

LABORERS CLASSIFICATIONS

GROUP 1 - General laborer-flagman, carpenter tenders; salamander Tenders; Dump Man; Ticket Takers; loading trucks under bins, hoppers, and conveyors; track man; cement handler; dump man on earth fill; georgie buggy man; material batch hopper man; spreader on asphalt machine; material mixer man (except on manholes); coffer dams; riprap pavers rock, block or brick; scaffolds over ten feet not self-supported from ground up; skip man on concrete paving; wire mesh setters on concrete paving; all work in connection with sewer, water, gas, gasoling, oil, drainage pipe, conduit pipe, tile and duct lines and all other pipe lines; power tool operator; all work in connection with hydraulic or general dredging operations; form setters, puddlers (paving only); straw blower nozzle man; asphalt plant platform man; chuck tender; crusher feeder; men handling creosote ties or creosote materials; men working with and handling epoxy material; topper of standing trees; feeder man on wood pulverizers, board and willow mat weavers and cabelee tiers on river work; deck hands; pile dike and revetment work; all laborers working on underground tunnels less than 25 ft. where compressed air is not used; abutement and pier hole men working six (6) ft. or more below ground; men working in coffer dams for bridge piers and footing in the river; barco tamper; jackson or any other similar tamp; cutting torch man; liners, curb, gutters, ditch lines; hot mastic kettlemen; hot tar applicator; hand blade operator; mortar men or brick or block manholes; rubbing concrete, air tool operator under 65 lbs.; caulker and lead man; chain or concrete saw under 15 h.p.; signal Gan; Guard rail and sign erectors.

GROUP 2 - Skilled laborers - Vibrator man; asphalt raker; head pipe layer on sewer work; batterboard man on pipe and ditch work; cliff scalers working from bosun's chairs; scaffolds or platforms on dams or power plants over 10 ft. high; air tool operator over 65 lbs.; stringline man on concrete paving; sandblast man; laser beam man; wagon drill; churn drill; air track drill and all other similar type drills, gunite nozzle man; pressure grout man; screed man on asphalt; concrete saw 15 h.p. and over; grade checker; strigline man on electronic grade control; manhole builder; dynamite man; powder man; welder; tunnel man; waterblaster - 1000 psi or over; asbestos and/or hazardous waste removal and/or disposal

-----  
LAB00955-012 05/01/2023

Adair, Audrain, Boone, Chariton, Cooper, Howard, Linn, Macon,  
Monroe, Putnam, Randolph, Schuyler and Sullivan Counties

Rates Fringes

LABORER

GROUP 1.....	\$ 32.98	15.62
GROUP 2.....	\$ 32.98	15.62

LABORERS CLASSIFICATIONS

GROUP 1 - General laborer-flagman, carpenter tenders; salamander Tenders; Dump Man; Ticket Takers; loading trucks under bins, hoppers, and conveyors; track man; cement handler; dump man on earth fill; georgie buggy man; material batch hopper man; spreader on asphalt machine; material mixer man (except on manholes); coffer dams; riprap pavers rock, block or brick; scaffolds over ten feet not self-supported from ground up; skip man on concrete paving; wire mesh setters on concrete paving; all work in connection with sewer, water, gas, gasoling, oil, drainage pipe, conduit pipe, tile and duct lines and all other pipe lines; power tool operator; all work in connection with hydraulic or general dredging operations; form setters, puddlers (paving only); straw blower nozzle man; asphalt plant platform man; chuck tender; crusher feeder; men handling creosote ties or creosote materials; men working with and handling epoxy material; topper of standing trees; feeder man on wood pulverizers, board and willow mat weavers and cabelee tiers on river work; deck hands; pile dike and revetment work; all laborers working on underground tunnels less than 25 ft. where compressed air is not used; abutment and pier hole men working six (6) ft. or more below ground; men working in coffer dams for bridge piers and footing in the river; barco tamper; jackson or any other similar tamp; cutting torch man; liners, curb, gutters, ditch lines; hot mastic kettlemen; hot tar applicator; hand blade operator; mortar men or brick or block manholes; rubbing concrete, air tool operator under 65 lbs.; caulker and lead man; chain or concrete saw under 15 h.p.; signal Gan; Guard rail and sign erectors.

GROUP 2 - Skilled laborers - Vibrator man; asphalt raker; head pipe layer on sewer work; batterboard man on pipe and ditch work; cliff scalers working from bosun's chairs; scaffolds or platforms on dams or power plants over 10 ft. high; air tool operator over 65 lbs.; stringline man on concrete paving; sandblast man; laser beam man; wagon drill; churn drill; air track drill and all other similar type drills, gunite nozzle man; pressure grout man; screed man on asphalt; concrete saw 15 h.p. and over; grade checker; strigline man on electronic grade control; manhole builder; dynamite man; powder man; welder; tunnel man; waterblaster - 1000 psi or over; asbestos and/or hazardous waste removal and/or disposal

-----  
 LAB01104-005 05/01/2023

Bollinger, Butler, Cape Girardeau, Carter, Dunklin, Iron, Madison, Mississippi, New Madrid, Pemiscot, Perry, Reynolds, Ripley, Scott, St Francois, Ste Genevieve, Stoddard and Wayne Counties

Rates Fringes

LABORER

GROUP 1.....	\$ 32.98	15.62
GROUP 2.....	\$ 32.98	15.62

LABORERS CLASSIFICATIONS

GROUP 1 - General laborer-flagman, carpenter tenders; salamander Tenders; Dump Man; Ticket Takers; loading trucks under bins, hoppers, and conveyors; track man; cement handler; dump man on earth fill; georgie buggy man; material batch hopper man; spreader on asphalt machine; material mixer man (except on manholes); coffer dams; riprap pavers rock, block or brick; scaffolds over ten feet not self-supported from ground up; skip man on concrete paving; wire mesh setters on concrete paving; all work in connection with sewer, water, gas, gasoling, oil, drainage pipe, conduit pipe, tile and duct lines and all other pipe lines; power tool operator; all work in connection with hydraulic or general dredging operations; form setters, puddlers (paving only); straw blower nozzle man; asphalt plant platform man; chuck tender; crusher feeder; men handling creosote ties or creosote materials; men working with and handling epoxy material; topper of standing trees; feeder man on wood pulverizers, board and willow mat weavers and cabelee tiers on river work; deck hands; pile dike and revetment work; all laborers working on underground tunnels less than 25 ft. where compressed air is not used; abutment and pier hole men working six (6) ft. or more below ground; men working in coffer dams for bridge piers and footing in the river; barco tamper; jackson or any other similar tamp; cutting torch man; liners, curb, gutters, ditch lines; hot mastic kettlemen; hot tar applicator; hand blade operator; mortar men or brick or block manholes; rubbing concrete, air tool operator under 65 lbs.; caulker and lead man; chain or concrete saw under 15 h.p.; signal Gan; Guard rail and sign erectors.

GROUP 2 - Skilled laborers - Vibrator man; asphalt raker; head pipe layer on sewer work; batterboard man on pipe and ditch work; cliff scalers working from bosun's chairs; scaffolds or platforms on dams or power plants over 10 ft. high; air tool operator over 65 lbs.; stringline man on concrete paving; sandblast man; laser beam man; wagon drill; churn drill; air track drill and all other similar type drills, gunite nozzle man; pressure grout man; screed man on asphalt; concrete saw 15 h.p. and over; grade checker; strigline man on electronic grade control; manhole builder; dynamite man; powder man; welder; tunnel man; waterblaster - 1000 psi or over; asbestos and/or hazardous waste removal and/or disposal

-----  
 PAIN002-002 09/01/2007

CLARK, FRANKLIN, JEFFERSON, LEWIS, LINCOLN, MARION, PIKE, RALLS, ST. CHARLES, ST. LOUIS (CITY & COUNTY), AND WARREN COUNTIES

Rates Fringes

Painters:

Brush and Roller; Taper.....	\$ 28.61	10.24
High work over 60 feet.....	\$ 29.11	10.24
Lead Abatement.....	\$ 29.36	10.24

Pressure Roller; High work under 60 ft.....	\$ 28.86	10.24
Spray & Abrasive Blasting; Water Blasting (Over 5000 PSI).....	\$ 30.61	10.24
Taper (Ames Tools & Bazooka).....	\$ 30.21	10.24

-----  
PAIN002-006 04/01/2023

ADAIR, AUDRAIN, BOONE, CALLAWAY, CHARITON, COLE, GASCONADE,  
HOWARD, KNOX, LINN, MACON, MONROE, MONTGOMERY, OSAGE, PUTNAM,  
RANDOLPH, SCHUYLER, SCOTLAND, SHELBY AND SULLIVAN COUNTIES and  
the City of Booneville.

Rates Fringes

Painters:

Bridges, Dams, Locks or Powerhouses.....	\$ 28.49	15.03
Brush and Roll; Taping, Paperhanging.....	\$ 26.49	15.03
Epoxy or Any Two Part Coating; Sandblasting; Stage or other Aerial Work - Platforms over 50 feet high; Lead Abatement.....	\$ 27.49	15.03
Spray; Structural Steel (over 50 feet).....	\$ 27.49	15.03
Tapers using Ames or Comparable Tools.....	\$ 27.24	15.03

-----  
PAIN003-004 04/01/2019

CASS, CLAY, CLINTON, JACKSON, JOHNSON, LAFAYETTE, PLATTE & RAY  
COUNTIES

Rates Fringes

Painters:

Bridgeman; Lead Abatement; Sandblast; Storage Bin & Tanks.....	\$ 33.41	17.76
Brush & Roller.....	\$ 30.54	17.76
Drywall.....	\$ 31.74	17.76
Paper Hanger.....	\$ 31.04	17.76
Stageman; Beltman; Steelman; Elevator Shaft; Bazooka, Boxes and Power Sander; Sprayman; Dipping...\$	32.41	17.76
Steeplejack.....	\$ 36.98	17.76

-----  
PAIN003-011 04/01/2019

BATES, BENTON, CALDWELL, CARROLL, COOPER, DAVIESS, GRUNDY,  
HARRISON, HENRY, LIVINGSTON, MERCER, MONITEAU, MORGAN, PETTIS &  
SALINE COUNTIES

Rates Fringes

Painters:

Bridgeman; Lead Abatement;

Sandblast; Storage Bin & Tanks.....	\$ 26.73	17.76
Brush & Roller.....	\$ 24.43	17.76
Drywall.....	\$ 25.39	17.76
Paper Hanger.....	\$ 24.83	17.76
Stageman; Beltman; Steelman; Elevator Shaft; Bazooka, Boxes and Power Sander; Sprayman; Dipping...	\$ 26.35	17.76
Steeplejack.....	\$ 29.58	17.76

-----  
PAIN1185-008 04/01/2024

CAMDEN, CRAWFORD, DENT, LACLEDE, MARIES, MILLER, PHELPS, PULASKI AND TEXAS COUNTIES

	Rates	Fringes
Painters:		
Brush and Roller.....	\$ 32.25	16.86
Floor Work.....	\$ 33.25	16.86
Lead Abatement.....	\$ 33.25	16.86
Spray.....	\$ 33.25	16.86
Structural Steel, Sandblasting and All Tank Work.....	\$ 34.25	16.86
Taping, Paperhanging.....	\$ 33.25	16.86

-----  
PAIN1292-002 09/01/2022

BOLLINGER, BUTLER, CAPE GIRARDEAU, CARTER, DUNKLIN, MISSISSIPPI, NEW MADRID, OREGON, PEMISCOT, PERRY, REYNOLDS, RIPLEY, SCOTT, SHANNON, STODDARD and WAYNE COUNTIES

	Rates	Fringes
Painters:		
Bridges, Stacks & Tanks.....	\$ 33.93	15.36
Brush & Roller.....	\$ 29.58	15.36
Spray & Abrasive Blasting; Waterblasting (over 5000 PSI).....	\$ 31.58	15.36

Height Rates (All Areas):  
Over 60 ft. \$0.50 per hour.  
Under 60 ft. \$0.25 per hour.

-----  
PAIN1292-003 09/01/2022

IRON, MADISON, ST. FRANCOIS, STE. GENEVIEVE and WASHINGTON COUNTIES

	Rates	Fringes
Painters:		
Bridges, Stacks & Tanks.....	\$ 33.93	15.36
Brush & Roller.....	\$ 29.58	15.36
Spray & Abrasive Blasting; Waterblasting (Over 5000 PSI).....	\$ 31.58	15.36



Height Rates (All Areas):  
Over 60 ft. \$0.50 per hour  
Under 60 ft. \$0.25 per hour.

-----  
PAIN2012-001 04/01/2023

ANDREW, ATCHISON, BUCHANAN, DE KALB, GENTRY, HOLT, NODAWAY & WORTH COUNTIES

Rates Fringes

Painters:

Brush & Roller.....	\$ 34.22	19.13
Sandblaster.....	\$ 38.46	19.13
Steeplejack.....	\$ 42.03	19.13

-----  
PAIN2015-001 04/01/2012

BARRY, BARTON, CEDAR, CHRISTIAN, DADE, DALLAS, DOUGLAS, GREENE, HICKORY, HOWELL, JASPER, LAWRENCE, MCDONALD, NEWTON, OZARK, POLK, ST. CLAIR, STONE, TANEY, VERNON, WEBSTER, and WRIGHT COUNTIES

Rates Fringes

Painters:

Finisher.....	\$ 20.18	11.33
Painter.....	\$ 19.75	11.76
Sandblaster, High Man, Spray Man, Vinyl Hanger, Tool Operator.....	\$ 21.18	11.33

-----  
PLAS0518-006 03/01/2023

BARRY, BARTON, CEDAR, CHRISTIAN, DADE, DALLAS, DOUGLAS, GREENE, HICKORY, JASPER, LACLEDE, LAWRENCE, MCDONALD, NEWTON, OZARK, POLK, ST. CLAIR, STONE, TANEY, VERNON, WEBSTER, AND WRIGHT COUNTIES

Rates Fringes

CEMENT MASON/CONCRETE FINISHER...	\$ 26.57	12.43
-----------------------------------	----------	-------

-----  
PLAS0518-007 04/01/2024

CASS (Richards-Gebaur AFB only), CLAY, JACKSON, PLATTE AND RAY COUNTIES

Rates Fringes

Cement Masons:.....	\$ 37.61	18.71
---------------------	----------	-------

-----  
PLAS0518-011 04/01/2023

ANDREW, ATCHISON, BATES, BUCHANAN, CLINTON, DEKALB, GENTRY, HENRY, HOLT, JOHNSON, LAFAYETTE, NODAWAY & WORTH COUNTIES

Rates Fringes

CEMENT MASON/CONCRETE FINISHER...\$ 36.03 20.50

-----  
PLAS0527-001 04/01/2023

Rates Fringes

CEMENT MASON

FRANKLIN, LINCOLN AND  
WARREN COUNTIES.....\$ 37.29 20.23

JEFFERSON, ST. CHARLES  
COUNTIES AND ST. LOUIS  
(City and County).....\$ 38.46 20.13

-----  
PLAS0527-004 06/01/2023

CRAWFORD, DENT, IRON, MADISON, MARION, PHELPS, PIKE, PULASKI,  
RALLS, REYNOLDS, ST. FRANCOIS, STE. GENEVIEVE, SHANNON, TEXAS,  
WASHINGTON COUNTIES

Rates Fringes

CEMENT MASON.....\$ 32.00 19.72

-----  
PLAS0908-001 05/01/2023

BOLLINGER, BUTLER, CAPE GIRARDEAU, CARTER, DUNKLIN, HOWELL,  
MISSISSIPPI, NEW MADRID, OREGON, PEMISCOT, PERRY, RIPLEY,  
SCOTT, STODDARD, AND WAYNE COUNTIES

Rates Fringes

CEMENT MASON.....\$ 32.30 18.38

-----  
PLAS0908-005 05/01/2023

BENTON, CALDWELL, CALLAWAY, CAMDEN, CARROLL, COLE, DAVIESS,  
GASCONADE, GRUNDY, HARRISON, LIVINGSTON, MACON, MARIES, MERCER,  
MILLER, MONTGOMERY, MORGAN, OSAGE, PETTIS & SALINE COUNTIES

Rates Fringes

CEMENT MASON.....\$ 32.30 18.38

-----  
PLUM0008-003 06/01/2024

CASS, CLAY, JACKSON, JOHNSON, AND PLATTE COUNTIES

Rates Fringes

Plumbers.....\$ 56.63 24.54

-----  
PLUM0008-017 06/01/2024

BATES, BENTON, CARROLL, HENRY, LAFAYETTE, MORGAN, PETTIS, RAY,  
ST. CLAIR, SALINE AND VERNON COUNTIES

Rates Fringes

Plumbers.....\$ 56.63 24.54

-----  
PLUM0045-003 08/01/2024

ANDREW, ATCHISON, BUCHANAN, CALDWELL, CLINTON, DAVIESS, DEKALB, GENTRY, HARRISON, HOLT, NODAWAY AND WORTH COUNTIES

	Rates	Fringes
Plumbers and Pipefitters.....	\$ 47.45	26.15

-----  
PLUM0178-003 11/01/2023

BARRY, CEDAR, CHRISTIAN, DADE, DALLAS, DOUGLAS, GREENE, HICKORY, LACLEDE, LAWRENCE, POLK, STONE, TANEY, WEBSTER AND WRIGHT COUNTIES

	Rates	Fringes
Plumbers and Pipefitters.....	\$ 37.15	15.42

-----  
PLUM0178-006 11/01/2022

BARTON, JASPER, MCDONALD AND NEWTON COUNTIES

	Rates	Fringes
Plumbers and Pipefitters		
Projects \$750,000 & under...	\$ 32.78	15.32
Projects over \$750,000.....	\$ 35.75	15.32

-----  
PLUM0533-004 06/01/2024

BATES, BENTON, CARROLL, CASS, CLAY, HENRY, HICKORY, JACKSON, JOHNSON, LAFAYETTE, MORGAN, PETTIS, PLATTE, RAY, SALINE, ST. CLAIR AND VERNON COUNTIES

	Rates	Fringes
Pipefitters.....	\$ 55.56	25.80

-----  
PLUM0562-004 07/01/2023

ADAIR, AUDRAIN, BOLLINGER, BOONE, BUTLER, CALLAWAY, CAMDEN, CAPE GIRARDEAU, CARTER, CHARITON, CLARK, COLE, COOPER, CRAWFORD, DENT, DUNKLIN, FRANKLIN, GASCONADE, GRUNDY, HOWARD, HOWELL, IRON, JEFFERSON, KNOX, LEWIS, LINCOLN, LINN, LIVINGSTON, MACON, MADISON, MARIES, MARION, MERCER, MILLER, MISSISSIPPI, MONITEAU, MONROE, MONTGOMERY, NEW MADRID, OREGON, OSAGE, PEMISCOTT, PERRY, PHELPS, PIKE, PULASKI, PUTNAM, RALLS, RANDOLPH, REYNOLDS, RIPLEY, ST. CHARLES, ST. FRANCOIS, STE. GENEVIEVE, ST. LOUIS, SCHUYLER, SCOTLAND, SCOTT, SHANNON, SHELBY, STODDARD, SULLIVAN, TEXAS, WARREN, WASHINGTON, AND WAYNE COUNTIES.

	Rates	Fringes
Plumbers and Pipefitters		
Mechanical Contracts		
including all piping and		
temperature control work		
\$7.0 million & under.....	\$ 46.66	21.99
Mechanical Contracts		
including all piping and		
temperature control work		

over \$7.0 million.....\$ 46.66 21.99

-----  
PLUM0562-016 07/01/2023

CAMDEN, COLE, CRAWFORD, FRANKLIN, JEFFERSON, MARIES, MILLER,  
MONITEAU, OSAGE, PHELPS, PULASKI, ST. CHARLES, ST. LOUIS (City  
and County), WARREN and WASHINGTON COUNTIES

Rates Fringes

Plumbers

Mechanical Contracts  
including all piping and  
temperature control work  
\$7.0 million & under.....\$ 46.66 21.99  
Mechanical Contracts  
including all piping and  
temperature control work  
over \$7.0 million.....\$ 46.66 21.99

-----  
TEAM0013-001 05/01/2024

Rates Fringes

Truck drivers (ADAIR, BUTLER,  
CLARK, DUNKIN, HOWELL, KNOX,  
LEWIS, OREGON, PUTNAM,  
RIPLEY, SCHUYLER AND SCOTLAND  
COUNTIES)

GROUP 1.....\$ 34.29 15.75  
GROUP 2.....\$ 34.44 15.75  
GROUP 3.....\$ 34.56 15.75  
GROUP 4.....\$ 34.45 15.75

Truck drivers (AUDRAIN,  
BOLLINGER, BOONE, CALLAWAY,  
CAPE GIRARDEAU, CARTER, COLE,  
CRAWFORD, DENT, GASCONADE,  
IRON, MACON, MADISON, MARIES,  
MARION, MILLER, MISSISSIPPI,  
MONROE, MONTGOMERY, NEW  
MADRID, OSAGE, PEMISCOT,  
PERRY, PHELPS, PIKE, PULASKI,  
RALLS, REYNOLDS, ST.  
FRANCOIS, STE. GENEVIEVE,  
SCOTT, SHANNON, SHELBY,  
STODDARD, TEXAS, WASHINGTON  
AND WAYNE COUNTIES)

GROUP 1.....\$ 35.02 15.75  
GROUP 2.....\$ 35.17 15.75  
GROUP 3.....\$ 35.29 15.75  
GROUP 4.....\$ 35.18 15.75

Truck drivers (FRANKLIN,  
JEFFERSON and ST. CHARLES  
COUNTIES)

GROUP 1.....\$ 37.38 15.75  
GROUP 2.....\$ 37.53 15.75  
GROUP 3.....\$ 37.60 15.75  
GROUP 4.....\$ 37.49 15.75

Truck drivers (LINCOLN and  
WARREN COUNTIES)

GROUP 1.....\$ 36.03 15.75  
GROUP 2.....\$ 37.18 15.75  
GROUP 3.....\$ 36.25 15.75  
GROUP 4.....\$ 36.14 15.75

TRUCK DRIVERS CLASSIFICATIONS:

GROUP 1: Flat Bed Trucks, Single Axle; Station Wagons; Pickup Trucks; Material Trucks, Single Axle; Tank Wagon, Single Axle

GROUP 2: Agitator and Transit Mix Trucks

GROUP 3: Flat Bed Trucks, Tandem Axle; Articulated Dump Trucks; Material Trucks, Tandem Axle; Tank Wagon, Tandem Axle

GROUP 4: Semi and/or Pole Trailers; Winch, Fork & Steel Trucks; Distributor Drivers and Operators; Tank Wagon, Semi-Trailer; Insley Wagons, Dumpsters, Half-Tracks, Speedace, Euclids and other similar equipment; A-Frame and Derrick Trucks; Float or Low Boy

-----  
TEAM0056-001 05/01/2024

	Rates	Fringes
Truck drivers (ANDREW, BARTON, BATES, BENTON, CALDWELL, CAMDEN, CARROLL, CEDAR, CHARITON, CHRISTIAN, CLINTON, COOPER, DADE, DALLAS, DAVIESS, DEKALB, DOUGLAS, GREENE, HENRY, HICKORY, HOWARD, JASPER, LACLEDE, LAWRENCE, LINN, LIVINGSTON, MONITEAU, MORGAN, NEWTON, PETTIS, POLK, RANDOLPH, ST. CLAIR, SALINE, VERNON, WEBSTER AND WRIGHT COUNTIES)		
GROUP 1.....	\$ 34.72	15.75
GROUP 2.....	\$ 34.88	15.75
GROUP 3.....	\$ 34.87	15.75
GROUP 4.....	\$ 34.99	15.75
Truck drivers: (ATCHISON, BARRY, GENTRY, GRUNDY, HARRISON, HOLT, MCDONALD, MERCER, NODAWAY, OZARK, STONE, SULLIVAN, TANEY AND WORTH COUNTIES)		
GROUP 1.....	\$ 33.99	15.75
GROUP 2.....	\$ 34.15	15.75
GROUP 3.....	\$ 34.14	15.75
GROUP 4.....	\$ 34.26	15.75
Truck drivers; (BUCHANAN, JOHNSON AND LAFAYETTE COUNTIES)		
GROUP 1.....	\$ 35.93	15.75
GROUP 2.....	\$ 36.04	15.75
GROUP 3.....	\$ 36.08	15.75
GROUP 4.....	\$ 36.08	15.75

TRUCK DRIVER CLASSIFICATIONS

GROUP 1: Flat bed trucks single axle; station wagons; pickup trucks; material trucks single axle; tank wagons single axle.

GROUP 2: Agitator and transit mix-trucks.

GROUP 3: Flat bed trucks tandem axle; articulated dump trucks; material trucks tandem axle; tank wagons tandem axle.

GROUP 4: Semi and/or pole trailers; winch, fork & steel trucks; distributor drivers & operators; tank wagons semi-trailer; insley wagons, dumpsters, half-tracks, speedace, euclids & other similar equipment; A-frames and derrick trucks; float or low boy.

-----  
TEAM0245-001 03/26/2012

BARRY, BARTON, CAMDEN, CEDAR, CHRISTIAN, DALLAS, DENT, DOUGLAS, GREENE, HICKORY, HOWELL, JASPER, LACLEDE, LAWRENCE, MCDONALD, MILLER, NEWTON, OZARK, PHELPS, POLK, PULASKI, SHANNON, STONE, TANEY, TEXAS, VERNON, WEBSTER AND WRIGHT COUNTIES

Rates Fringes

Truck drivers:

Traffic Control Service  
Driver.....\$ 20.45 0.00

PAID HOLIDAYS: New Year's Day, Decoration Day, July 4th, Labor Day, Thanksgiving Day, Christmas Day, employee's birthday and 2 personal days.

-----  
TEAM0541-001 04/01/2024

CASS, CLAY, JACKSON, PLATTE AND RAY COUNTIES

Rates Fringes

Truck drivers:

GROUP 1.....\$ 37.81 15.65  
GROUP 2.....\$ 37.24 15.65  
GROUP 3.....\$ 36.72 15.65

TRUCK DRIVERS CLASSIFICATIONS

GROUP 1: Mechanics and Welders, Field; A-Frame Low Boy-Boom ruck Driver.

GROUP 2: Articulated Dump Truck; Insley Wagons: Dump Trucks, Excavating, 5 cu yds and over; Dumpsters; Half-Tracks: Speedace: Euclids & similar excavating equipment Material trucks, Tandem Two teams; Semi-Trailers; Winch trucks-Fork trucks; Distributor Drivers and Operators; Agitator and Transit Mix; Tank Wagon Drivers, Tandem or Semi; One Team; Station Wagons; Pickup Trucks; Material Trucks, Single Axle; Tank Wagon Drivers, Single Axle

GROUP 3: Oilers and Greasers - Field

-----  
TEAM0682-002 05/01/2024

ST LOUIS CITY AND COUNTY

Rates Fringes

Truck drivers:

GROUP 1.....	\$ 36.64	8.86+a+b+c
GROUP 2.....	\$ 36.64	8.86+a+b+c
GROUP 3.....	\$ 36.64	8.86+a+b+c

a. PENSION: 5/1/2012 - \$182.20 per week.

b. HAZMAT PREMIUM: If Hazmat certification on a job site is required by a state or federal agency or requested by project owner or by the employer, employees on that job site shall receive \$1.50 premium pay.

TRUCK DRIVERS CLASSIFICATIONS

GROUP 1 - Pick-up trucks; forklift, single axle; flatbed trucks; job site ambulance, and trucks or trailers of a water level capacity of 11.99 cu. yds. or less

GROUP 2 - Trucks or trailers of a water level capacity of 12.0 cu yds. up to 22.0 cu yds. including euclids, speedace and similar equipment of same capacity and compressors

GROUP 3 - Trucks or trailers of a water level capacity of 22.0 cu. yds & over including euclids, speedace & all floats, flatbed trailers, boom trucks, winch trucks, including small trailers, farm wagons tilt-top trailers, field offices, tool trailers, concrete pumps, concrete conveyors & gasoline tank trailers and truck mounted mobile concrete mixers

FOOTNOTE FOR TRUCK DRIVERS:

c. PAID HOLIDAYS: Christmas Day, Independence Day, Labor Day, Memorial Day, Veterans Day, New Years Day, Thanksgiving Day

d. PAID VACATION: 3 days paid vacation for 600 hours of service in any one contract year; 4 days paid vacation for 800 hours of service in any one contract year; 5 days paid vacation for 1,000 hours of service in any one contract year. When such an employee has completed 3 years of continuous employment with the same employer and then works the above required number of hours, he shall receive double the number of days of vacation specified above. When such an employee has completed 10 years of continuous employment with the same employer and then works the above required number of hours, he shall receive triple the number of days of vacation specified above. When such an employee has completed 15 years of continuous employment with the same employer and then works the above required number of hours, he shall receive 4 times the number of days of vacation specified above.

-----  
WELDERS - Receive rate prescribed for craft performing operation to which welding is incidental.

=====  
Note: Executive Order (EO) 13706, Establishing Paid Sick Leave for Federal Contractors applies to all contracts subject to the Davis-Bacon Act for which the contract is awarded (and any

solicitation was issued) on or after January 1, 2017. If this contract is covered by the EO, the contractor must provide employees with 1 hour of paid sick leave for every 30 hours they work, up to 56 hours of paid sick leave each year. Employees must be permitted to use paid sick leave for their own illness, injury or other health-related needs, including preventive care; to assist a family member (or person who is like family to the employee) who is ill, injured, or has other health-related needs, including preventive care; or for reasons resulting from, or to assist a family member (or person who is like family to the employee) who is a victim of, domestic violence, sexual assault, or stalking. Additional information on contractor requirements and worker protections under the EO is available at <https://www.dol.gov/agencies/whd/government-contracts>.

Unlisted classifications needed for work not included within the scope of the classifications listed may be added after award only as provided in the labor standards contract clauses (29CFR 5.5 (a) (1) (iii)).

-----

The body of each wage determination lists the classification and wage rates that have been found to be prevailing for the cited type(s) of construction in the area covered by the wage determination. The classifications are listed in alphabetical order of ""identifiers"" that indicate whether the particular rate is a union rate (current union negotiated rate for local), a survey rate (weighted average rate) or a union average rate (weighted union average rate).

#### Union Rate Identifiers

A four letter classification abbreviation identifier enclosed in dotted lines beginning with characters other than ""SU"" or ""UAVG"" denotes that the union classification and rate were prevailing for that classification in the survey. Example: PLUM0198-005 07/01/2014. PLUM is an abbreviation identifier of the union which prevailed in the survey for this classification, which in this example would be Plumbers. 0198 indicates the local union number or district council number where applicable, i.e., Plumbers Local 0198. The next number, 005 in the example, is an internal number used in processing the wage determination. 07/01/2014 is the effective date of the most current negotiated rate, which in this example is July 1, 2014.

Union prevailing wage rates are updated to reflect all rate changes in the collective bargaining agreement (CBA) governing this classification and rate.

#### Survey Rate Identifiers

Classifications listed under the ""SU"" identifier indicate that no one rate prevailed for this classification in the survey and the published rate is derived by computing a weighted average rate based on all the rates reported in the survey for that classification. As this weighted average rate includes all rates reported in the survey, it may include both union and non-union rates. Example: SULA2012-007 5/13/2014. SU indicates the rates are survey rates based on a weighted average calculation of rates and are not majority rates. LA indicates



the State of Louisiana. 2012 is the year of survey on which these classifications and rates are based. The next number, 007 in the example, is an internal number used in producing the wage determination. 5/13/2014 indicates the survey completion date for the classifications and rates under that identifier.

Survey wage rates are not updated and remain in effect until a new survey is conducted.

#### Union Average Rate Identifiers

Classification(s) listed under the UAVG identifier indicate that no single majority rate prevailed for those classifications; however, 100% of the data reported for the classifications was union data. EXAMPLE: UAVG-OH-0010 08/29/2014. UAVG indicates that the rate is a weighted union average rate. OH indicates the state. The next number, 0010 in the example, is an internal number used in producing the wage determination. 08/29/2014 indicates the survey completion date for the classifications and rates under that identifier.

A UAVG rate will be updated once a year, usually in January of each year, to reflect a weighted average of the current negotiated/CBA rate of the union locals from which the rate is based.

#### State Adopted Rate Identifiers

Classifications listed under the "SA" identifier indicate that the prevailing wage rate set by a state (or local) government was adopted under 29 C.F.R. 1.3(g)-(h). Example: SAME2023-007 01/03/2024. SA reflects that the rates are state adopted. ME refers to the State of Maine. 2023 is the year during which the state completed the survey on which the listed classifications and rates are based. The next number, 007 in the example, is an internal number used in producing the wage determination. 01/03/2024 reflects the date on which the classifications and rates under the SA identifier took effect under state law in the state from which the rates were adopted.

---

#### WAGE DETERMINATION APPEALS PROCESS

1.) Has there been an initial decision in the matter? This can be:

- \* an existing published wage determination
- \* a survey underlying a wage determination
- \* a Wage and Hour Division letter setting forth a position on a wage determination matter
- \* a conformance (additional classification and rate) ruling

On survey related matters, initial contact, including requests for summaries of surveys, should be with the Wage and Hour National Office because National Office has responsibility for the Davis-Bacon survey program. If the response from this initial contact is not satisfactory, then the process described in 2.) and 3.) should be followed.

With regard to any other matter not yet ripe for the formal process described here, initial contact should be with the Branch of Construction Wage Determinations. Write to:

Branch of Construction Wage Determinations

Wage and Hour Division  
U.S. Department of Labor  
200 Constitution Avenue, N.W.  
Washington, DC 20210

2.) If the answer to the question in 1.) is yes, then an interested party (those affected by the action) can request review and reconsideration from the Wage and Hour Administrator (See 29 CFR Part 1.8 and 29 CFR Part 7). Write to:

Wage and Hour Administrator  
U.S. Department of Labor  
200 Constitution Avenue, N.W.  
Washington, DC 20210

The request should be accompanied by a full statement of the interested party's position and by any information (wage payment data, project description, area practice material, etc.) that the requestor considers relevant to the issue.

3.) If the decision of the Administrator is not favorable, an interested party may appeal directly to the Administrative Review Board (formerly the Wage Appeals Board). Write to:

Administrative Review Board  
U.S. Department of Labor  
200 Constitution Avenue, N.W.  
Washington, DC 20210

4.) All decisions by the Administrative Review Board are final.

=====

END OF GENERAL DECISION"

Date	
Revision/Issue	
SEE ADDENDUM 2	

**GENERAL NOTES:**  
 DRAWING NOT TO SCALE. FOLLOW DIMENSIONS.  
 MINIMUM CLEARANCE TO REINFORCING STEEL SHALL BE 1 1/2".  
 LAP LONGITUDINAL BARS A MINIMUM OF 23" AT SPLICES.  
 (d) SAME SIZE AND SPACING AS A2 BARS  
 (e) A2 BAR SPACING

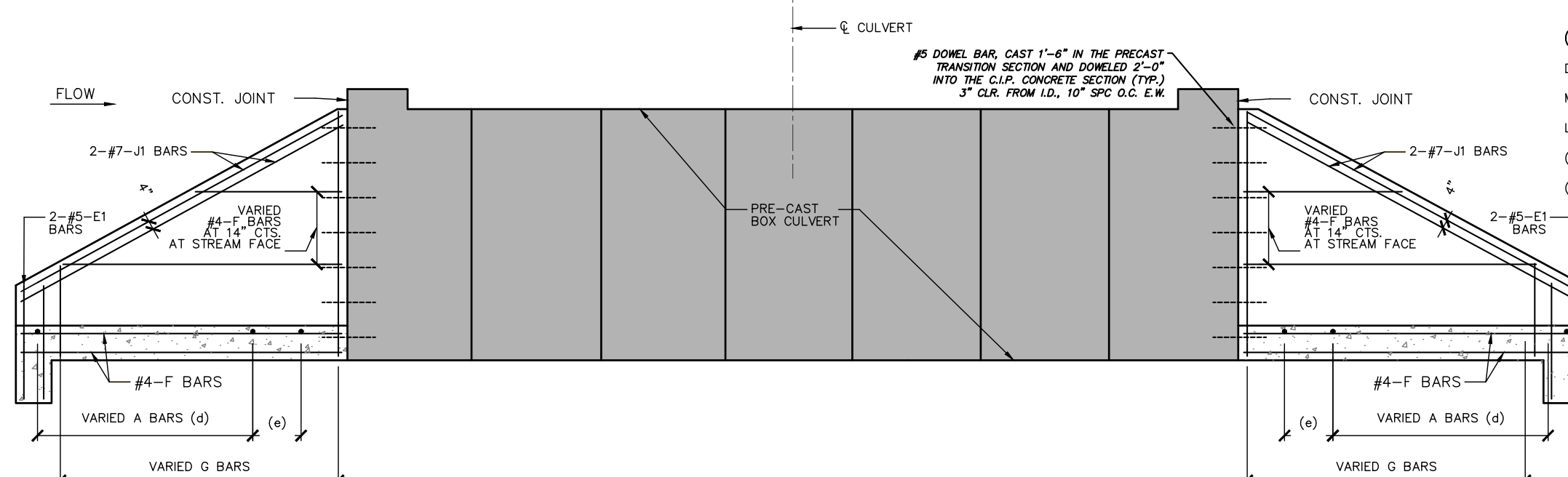

**ELEVATION OF PRECAST BOX WITH CAST IN PLACE WINGWALLS**

J1 BARS MAY BE BENT IN FIELD OR SHOP.

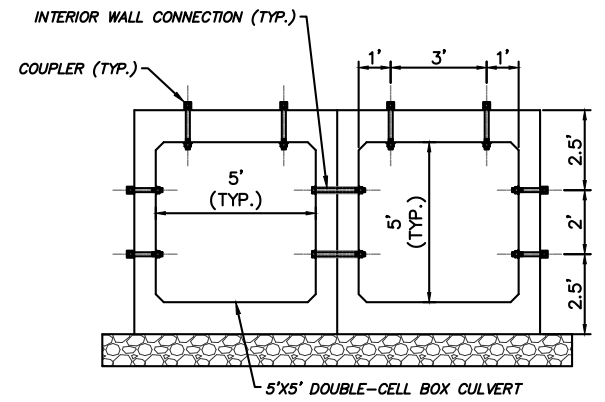

**DOUBLE-CELL CONNECTION DETAILS**

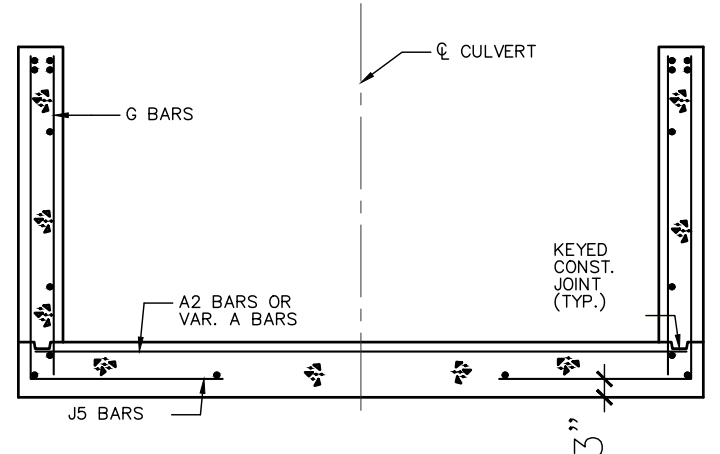

**UPSTREAM AND DOWNSTREAM WINGS REINFORCEMENT**

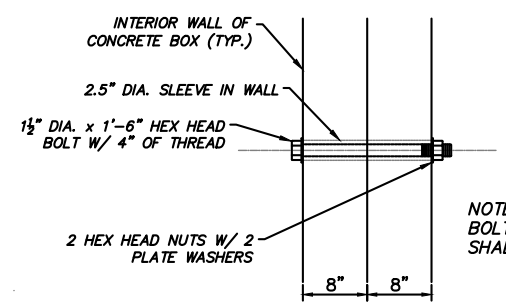

**INTERIOR SIDEWALL CONNECTION DETAIL**

NOTES:  
 BOLTS, NUTS, WASHERS, AND SLEEVES  
 SHALL BE ZINC PLATED OR GALVANIZED

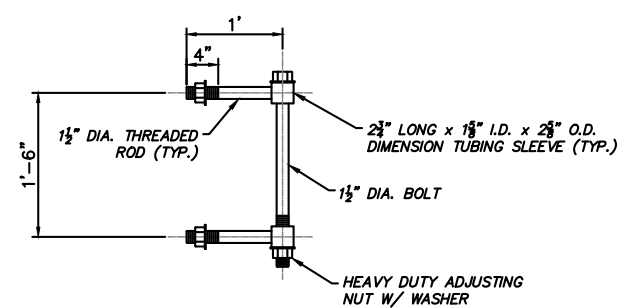

NOTES:  
 BOLTS, NUTS, WASHERS, AND SLEEVES  
 SHALL BE ZINC PLATED.  
 NUTS SHALL BE INSTALLED SNUG TIGHT  
 AND NOT TIGHTENED W/ IMPACT WRENCHES.

**COUPLER DETAIL**

DESIGN FILL	MEMBER THICKNESS			SPAN (S) = ## FT								HEIGHT (HT) = 5 FT							
	TS	BS	TX	TOP SLAB BARS				BOTTOM SLAB BARS				WALL BARS							
				A1 BARS	J3 BARS			A2 BARS	J4 BARS			B2 BARS							
SIZE	SPA.	C1	K2	SIZE	SPA.	C4	K3	SIZE	SPA.	G1									
1 FT	13	12	8	6	6	5	7	102.1	33.3	6	6.5	6	6.5	66.9	68	5	12	12	
2 FT	13	12	8	7	8	5	6	102.1	33.3	6	6	6	6	58.1	68	5	12	12	

IF A SEAL IS PRESENT ON THIS SHEET, IT HAS BEEN ELECTRONICALLY SEALED AND DATED

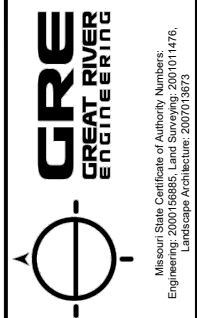
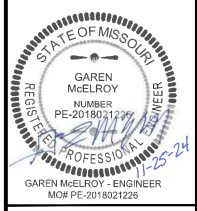

**ALBANY AVENUE PEDESTRIAN AND STORMWATER IMPROVEMENTS**  
 CITY OF BOLIVAR, POLK COUNTY, MISSOURI  
 TAP-6701807  
 STRUCTURAL DETAILS

Z:\Shared\Projects\4689 - City of Bolivar South Albany Pedestrian & Stormwater Improvements\9 Drawings\Plan Set\4689\_STRUCTURAL\_DETAILS.dwg PLOT DATE: 11/23/2024 4:05:27 PM LAST SAVE: 11/23/2024 4:04:46 PM