

PART SECTION A-A

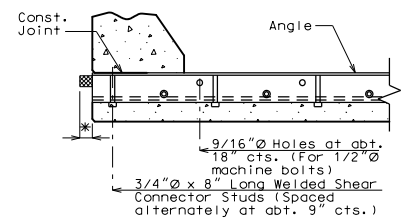

PART SECTION B-B

* Extend preformed compression seal 3" past the edge of slab (Typ.)

GENERAL NOTES:

Expansion joint system shall be fabricated in one section, except for staged construction and when the length is over 50 feet. A complete joint penetration groove welded splice shall be required. Welds shall be ground flush to provide a smooth surface. The expansion joint system shall be fabricated and installed to the crown and grade of the roadway.

Structural steel for the expansion joint system shall be ASTM A709 Grade 36. Anchors for the expansion joint system shall be in accordance with Sec 1037. Preformed compression seal expansion joint system shall be in accordance with Sec 717.

Structural steel for the expansion joint system shall be coated with a minimum of two coats of inorganic zinc primer to provide a total dry film thickness of 4 mils minimum, 6 mils maximum, or galvanized in accordance with ASTM A123. Anchors need not be protected from overspray.

Concrete shall be forced under armor angle and around anchors. Proper consolidation of the concrete shall be achieved by localized internal vibration.

Longitudinal reinforcing steel shall be placed so that ends shall be 1" from the vertical leg of the angle at the expansion joint system.

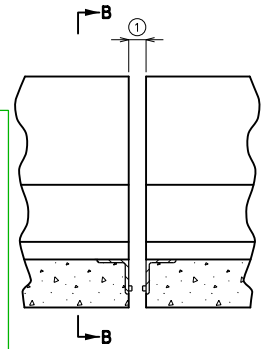

PART ELEVATION OF BARRIER

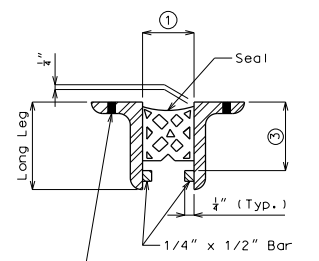

SECTION THRU DEVICE

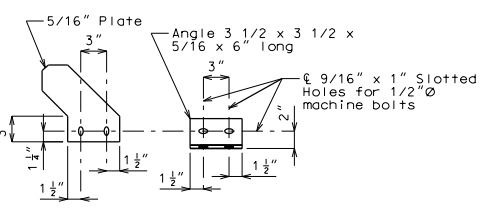

DETAIL B

Seal Width Perpendicular to Joint	Height ③	Movement Capacity (Normal to Joint)	Min. Joint Width (Normal to Joint)	Max. Joint Width (Normal to Joint)	Allowed Installation Gap Normal to Joint at RDWY Surface @ Air/Surface Temperature ②				Manufacturer	Seal Name
					①					
					@ 40°F	@ 50°F	@ 60°F	@ 70°F		
2.25"	Manufacturer's Recommended Height	0.85"	1.06"	1.91"	XXX	XXX	XXX	XXX		
2.5"	Manufacturer's Recommended Height	1.00"	1.13"	2.13"	XXX	XXX	XXX	XXX		
3.0"	Manufacturer's Recommended Height	1.30"	1.25"	2.55"	XXX	XXX	XXX	XXX		
3.5"	Manufacturer's Recommended Height	1.60"	1.38"	2.98"	XXX	XXX	XXX	XXX		
4.0"	Manufacturer's Recommended Height	1.83"	1.57"	3.40"	XXX	XXX	XXX	XXX		
4.5"	Manufacturer's Recommended Height	2.27"	1.56"	3.83"	XXX	XXX	XXX	XXX		

Note: Depth of seal shall not be less than width of seal.

Size of armor angle: Vertical leg of angle shall be a minimum of Manufacturer's Recommended Height ③ + 3/4". Horizontal leg of angle shall be a minimum of 3". Minimum thickness of angle shall be 1/2".

② The installation temperature shall be taken as the actual air temperature averaged over the 24-hour period immediately preceding installation.

MoDOT Construction personnel will record the manufacturer and seal name that was used.

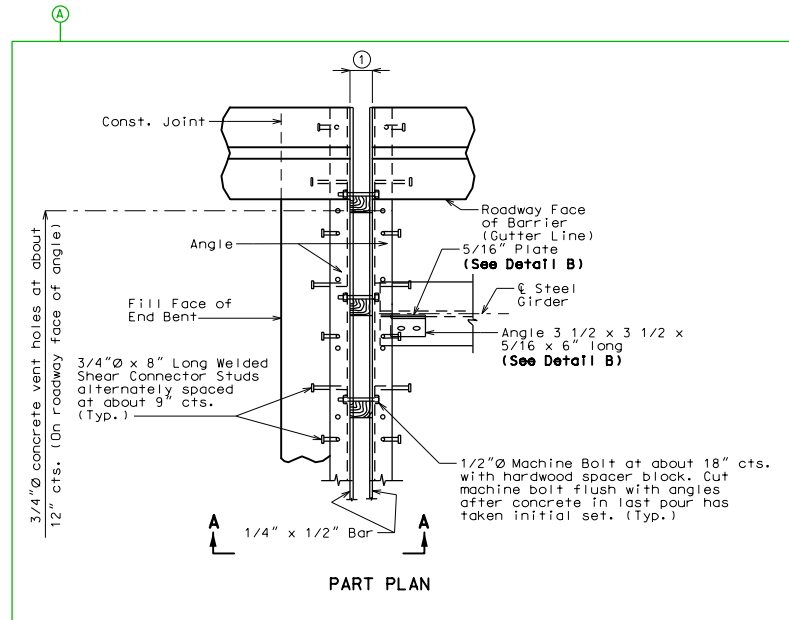

PART PLAN

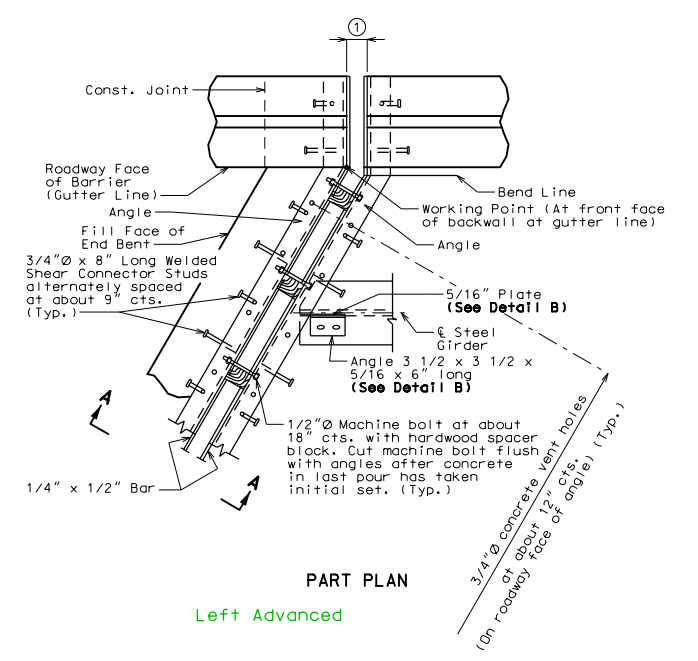

PART PLAN

Left Advanced

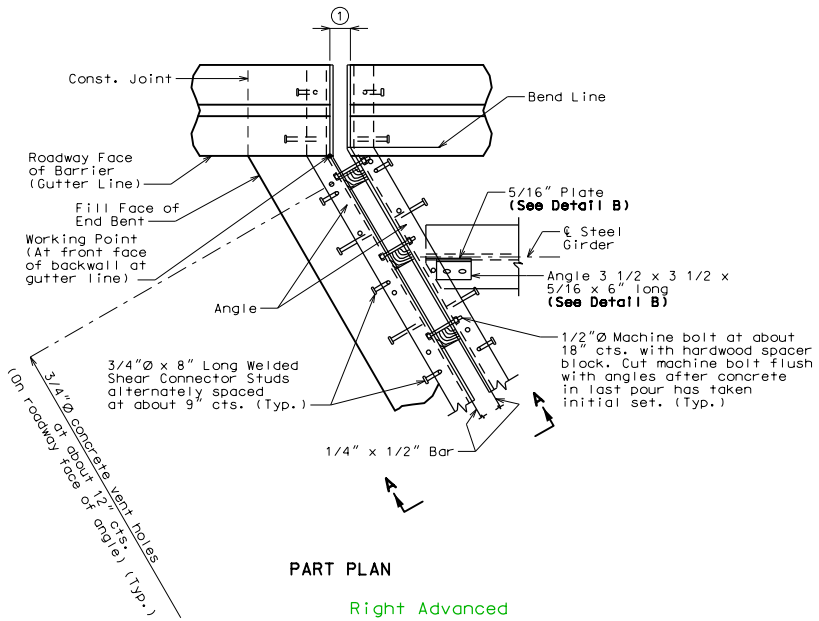

PART PLAN

Right Advanced

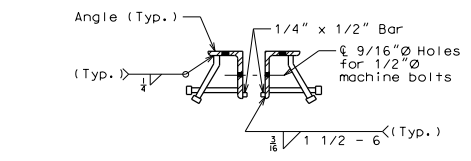

DETAIL A

PREFORMED COMPRESSION SEAL EXPANSION JOINT SYSTEM AT END BENT NO. _

Note: This drawing is not to scale. Follow dimensions. Sheet No. of

THIS MEDIA SHOULD NOT BE CONSIDERED A CERTIFIED DOCUMENT.

DATE PREPARED: 2/9/2021

ROUTE: MO DISTRICT: BR SHEET NO.:

COUNTY: *

JOB NO.:

CONTRACT ID.:

PROJECT NO.:

BRIDGE NO. P_COM02

DESCRIPTION:

DATE:

MISSOURI HIGHWAYS AND TRANSPORTATION COMMISSION

MoDOT

105 WEST CAPITOL JEFFERSON CITY, MO 65102 1-888-ASK-MODOT (1-888-275-6636)

REV.:

STANDARD DRAWING GUIDANCE (do not show on plans):

For slab thickness < 8 1/2", check shear connector stud length for clearance to flange or diaphragm and adjust length as necessary. See Structural Project Manager.

Use standard detailing note H5.55 when polymer concrete wearing surface is used with a preformed compression seal.

Remove non-applicable rows in table.

Ⓐ Use squared, left advanced or right advanced Part Plan as needed.

Ⓑ = 3/4" (Min.) @ 60° Verify only.

Ⓒ = Ⓐ @ 60° + 3/4" (Min.) Verify only.

Delete panels for CIP slab.

Detailed Checked