

DIMENSIONS

(1) Fabricator shall apply a bond breaker to this region excluding where joint filler will be applied.

(2) 1 1/2" (Typ.) (3/4" Optional)

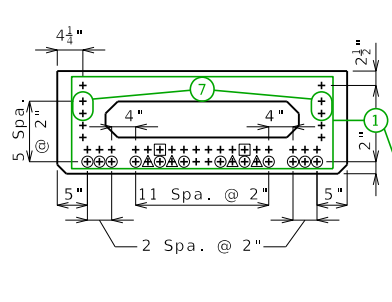

STRAND ARRANGEMENT

All strands are fully bonded unless otherwise noted.

- + Indicates prestressing strand.
- Indicates cut and shop bend with 2'-0" projection.
- Indicates debonded for X'-X' from end of beam.
- △ Indicates debonded for X'-X' from end of beam.

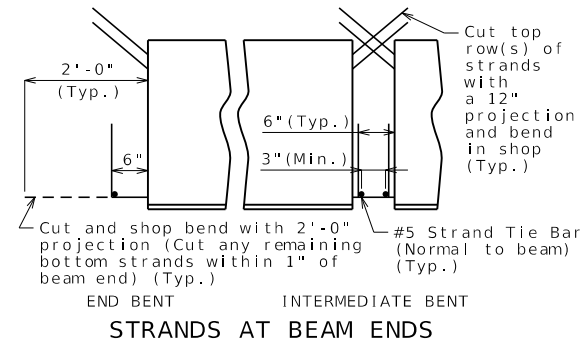

STRANDS AT BEAM ENDS

BILL OF REINFORCING STEEL - EACH BEAM				BENDING DIAGRAM	
NO.	SIZE & MARK	ACTUAL LENGTH	SHAPE		
10	5 A1 X'-X''	20		(S1) 3'-7"	(S5) 3'-8 1/2"
8	4 A2 X'-X''	20		(S4) 3'-8 1/2"	(S7) 2'-8 1/2"
				(S6) 2'-8 1/2"	
X	4 C1 3'-7"	20		(#4)	(#5)
				14 1/2"	14 1/2"
X	4 S1 6'-4"	10		(S1, S4, S6)	(S5, S7)
X	4 S2 6'-2"	51		SHAPE 10	
				21"	
X	4 S3 4'-6"	50		(U1)	
				13"	
18	5 S4 6'-8"	10		SHAPE 10	
18	5 S5 5'-10"	10		2'-11 1/4"	3'-5 3/4"
				SHAPE 21	
2	5 S6 5'-8"	10			
2	5 S7 4'-10"	10		SHAPE 20	
				10"	2 1/2"
				6"	18"
				SHAPE 50	
12	6 U1 4'-3"	10			
				7 3/4"	7 3/4"
4	4 U2 8'-4"	21		13 3/4"	12"
				SHAPE 51	

All dimensions are out to out. Use symmetry for dimensions not shown.

Hooks and bends shall be in accordance with the CRSI Manual of Standard Practice for Detailing Reinforced Concrete Structures, Stirrup and Tie Dimensions.

Actual lengths are measured along centerline of bar to the nearest inch.

Minimum clearance to reinforcing shall be 1", unless otherwise shown.

All reinforcement shall be Grade 60. All S2 bars shall be epoxy coated.

General Notes:
Concrete for prestressed beams shall be Class A-1 with f'c = psi and f'cl = psi.
Use strands, #Ø Grade 270, with an initial prestress force of 6 kips.

Pretensioned members shall be in accordance with Sec 1029.

Fabricator shall be responsible for location and design of lifting devices.

Exterior and interior beams are the same except: coil ties, application of bond breaker, coil inserts for slab drains.

For Beam Camber Diagram, see Sheet No. __.

For location of coil inserts at slab drains, see Sheet No. __.

For location of coil ties at concrete bent diaphragms, see Sheets No. __ and __.

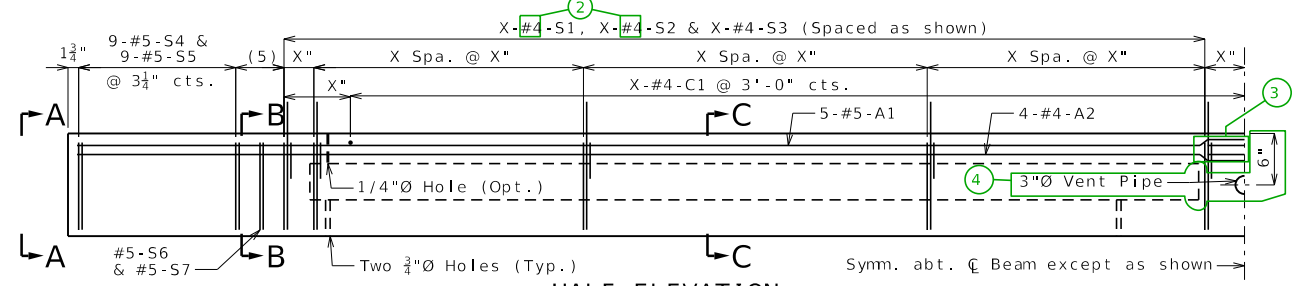

HALF ELEVATION

Dimensions taken along C Beam.

(5) 2 Spa. @ 4"

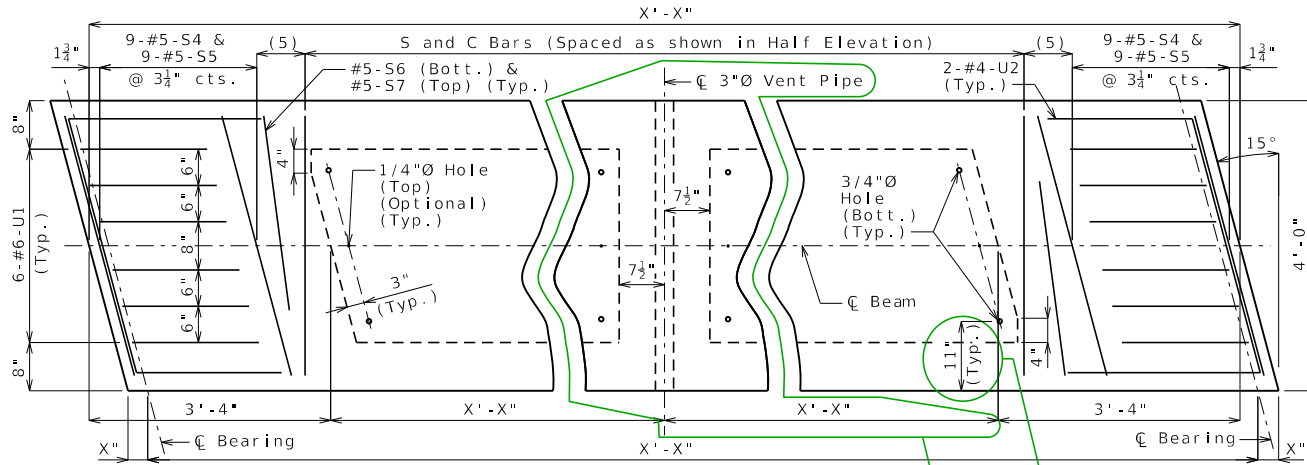

PART PLAN

Mirror about C Beam for left advanced.

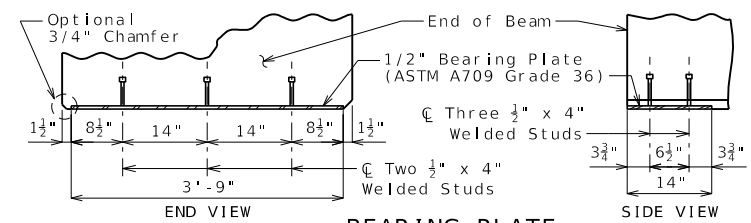

BEARING PLATE

SPREAD BOX BEAMS - SPANS (X-X) AND (X-X)

Note: This drawing is not to scale. Follow dimensions.

Strands not shown for clarity.

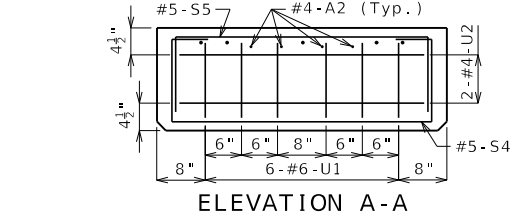

ELEVATION A-A

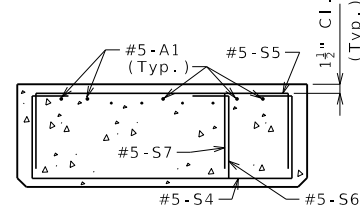

SECTION B-B

Mirror for left advanced.

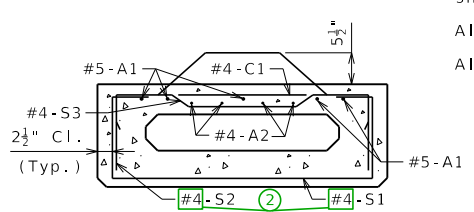

SECTION C-C

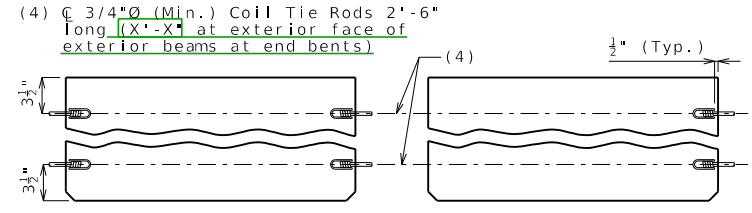

COIL TIES

Detailed Checked

Sheet No. of

MISSOURI HIGHWAYS AND TRANSPORTATION COMMISSION

DATE PREPARED: 5/4/2023

ROUTE: MO

DISTRICT: 2

COUNTY:

JOB NO.:

CONTRACT ID.:

PROJECT NO.:

BRIDGE NO.:

DESCRIPTION:

DATE:

105 WEST CAPITOL JEFFERSON CITY, MO 65102 1-888-ASK-MODOT (1-888-275-6636)

IF A SEAL IS PRESENT ON THIS SHEET IT HAS BEEN ELECTRONICALLY SEALED AND DATED.

STANDARD DRAWING GUIDANCE (do not show on plans):
(Turn off Level Bridge-Guidance to hide guidance)

- ① Actual strand arrangement, bent up strands, and debonding (if any) is by design (top two strands are required). Add or remove symbols and instructions as required. Strands may be placed continuously across beam (eliminating 4" space), but dimension to drain hole in Part Plan shall be revised to 10".
- ② Revise if #5 is required. Use 6'-7" for #5-S1 actual length and 6'-1" for #5-S2 actual length.
- ③ Splices shown only when necessary (girder length > 60'-2"). Use 2'-1" lap for #4 & 2'-7" lap for #5.

When lap is unnecessary:
 - Delete grouped elements.
 - Extend A bars to \bar{C} Beam.
 - Revise 10 to 5 A1 bars & 8 to 4 A2 bars.
- ④ Interior diaphragm & vent pipe shall be shown only when necessary (when structure may be submerged).

When not necessary:
 - Delete the two grouped elements.
 - In Half Elev. extend hidden lines to \bar{C} Beam.
 - In Part Plan revise remaining dimension to full length of void.
- ⑤ Revise minimum dimension if required by design.
- ⑥ By design. Typically 30.98 kips per 0.5" strand & 43.94 kips per 0.6" strand, rounded to nearest whole kip.
- ⑦ Strand location not available when vent pipe is required.