

PART SECTION A-A
* Dimension along G Girder

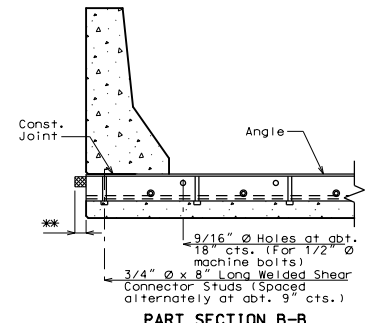

PART SECTION B-B
** Extend preformed compression seal 3" past the edge of slab (Typ.)

GENERAL NOTES:

Expansion joint system shall be fabricated in one section, except for staged construction and when the length is over 50 feet. A complete joint penetration groove welded splice shall be required. Welds shall be ground flush to provide a smooth surface. The expansion joint system shall be fabricated and installed to the crown and grade of the roadway.

Structural steel for the expansion joint system shall be ASTM A709 Grade 36. Anchors for the expansion joint system shall be in accordance with Sec 1037. Preformed compression seal expansion joint system shall be in accordance with Sec 717.

Structural steel for the expansion joint system shall be coated with a minimum of two coats of inorganic zinc primer (5 mils minimum) or galvanized in accordance with ASTM A123. Anchors need not be protected from overspray.

Concrete shall be forced under armor angle and around anchors. Proper consolidation of the concrete shall be achieved by localized internal vibration.

Longitudinal reinforcing steel shall be placed so that ends shall be 1" from the vertical leg of the angle at the expansion joint system.

"THIS MEDIA SHOULD NOT BE CONSIDERED A CERTIFIED DOCUMENT."

DATE PREPARED	5/17/2018
ROUTE	STATE
DISTRICT	MO
SHEET NO.	BR
COUNTY	*
JOB NO.	*
CONTRACT ID.	*
PROJECT NO.	
BRIDGE NO.	PCSEJS01

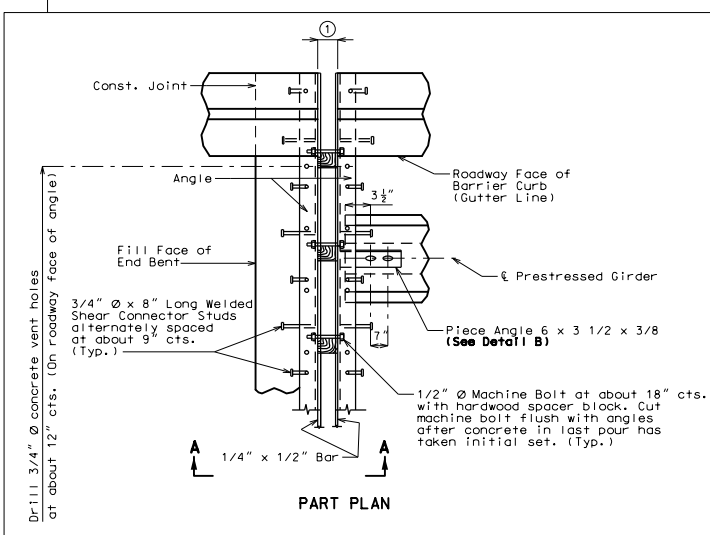

PART PLAN

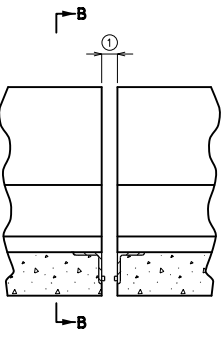

PART ELEVATION OF BARRIER CURB

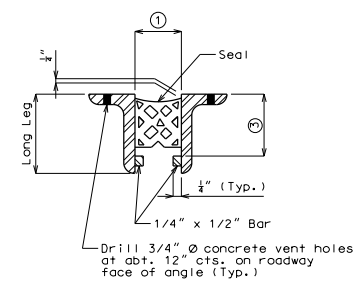

PART CROSS SECTION THRU EXPANSION JOINT

Table of Transverse Preformed Compression Seal Expansion Joint System Dimensions

Seal Width Perpendicular to Joint	③	Movement Capacity (M ⊥ to Joint)	Min. Joint Width (⊥ to Joint)	Max. Joint Width (⊥ to Joint)	Allowed Installation Gap Normal to Joint at RDWY Surface @ Air/Surface Temperature ②				④
					@ 40°F	@ 50°F	@ 60°F	@ 70°F	
2.25"	Manufacturer's Recommended Height	0.90"	1.01"	1.91"	XXX	XXX	XXX	XXX	□
2.5"	Manufacturer's Recommended Height	1.00"	1.13"	2.13"	XXX	XXX	XXX	XXX	□
3.0"	Manufacturer's Recommended Height	1.20"	1.34"	2.55"	XXX	XXX	XXX	XXX	□
3.5"	Manufacturer's Recommended Height	1.40"	1.58"	2.98"	XXX	XXX	XXX	XXX	□
4.0"	Manufacturer's Recommended Height	1.65"	1.75"	3.40"	XXX	XXX	XXX	XXX	□
4.5"	Manufacturer's Recommended Height	1.80"	2.03"	3.83"	XXX	XXX	XXX	XXX	□

Note: Depth of seal shall not be less than width of seal.

Size of armor angle:
Vertical leg of angle shall be a minimum of Manufacturer's Recommended Height ③ + 3/4". Horizontal leg of angle shall be a minimum of 3". Minimum thickness of angle shall be 1/2".

② The installation temperature shall be taken as the actual air temperature averaged over the 24-hour period immediately preceding installation.

④ MoDOT Construction personnel will indicate the preformed compression seal expansion joint system installed.

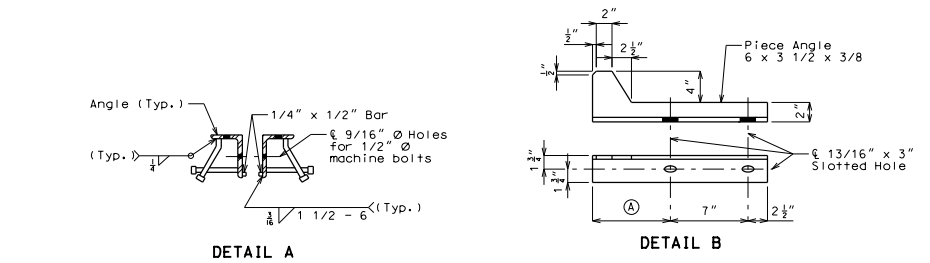

DETAIL A

DETAIL B

DETAILS OF PREFORMED COMPRESSION SEAL EXPANSION JOINT SYSTEM AT END BENT NO.

Detailed Checked Note: This drawing is not to scale. Follow dimensions. Sheet No. of

STANDARD DRAWING GUIDANCE (do not show on plans):

For slab thickness < 8 1/2", check shear connector stud length for clearance to flange or diaphragm and adjust length as necessary. See Structural Project Manager.

Remove non-applicable rows in table.

- Ⓐ Piece angle length to center of first slotted hole.
- Ⓑ Use squared, left advanced or right advanced Part Plan as needed.
- Ⓒ = 3/4" (Min.) @ 60° Verify only.
- Ⓓ = ① @ 60° + 3/4" (Min.) Verify only.

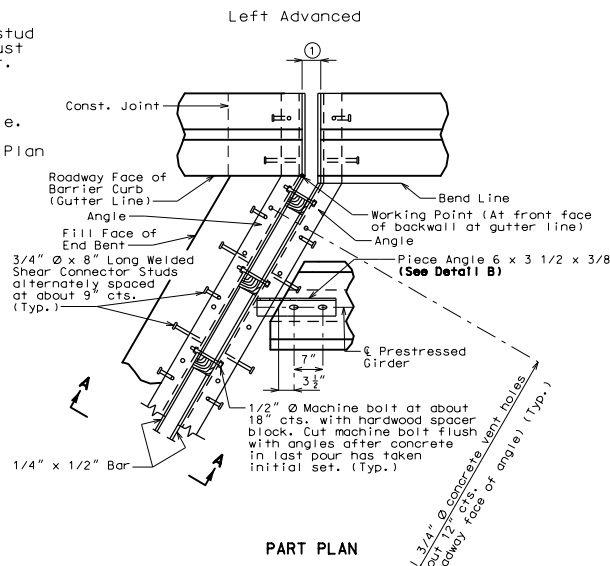

PART PLAN

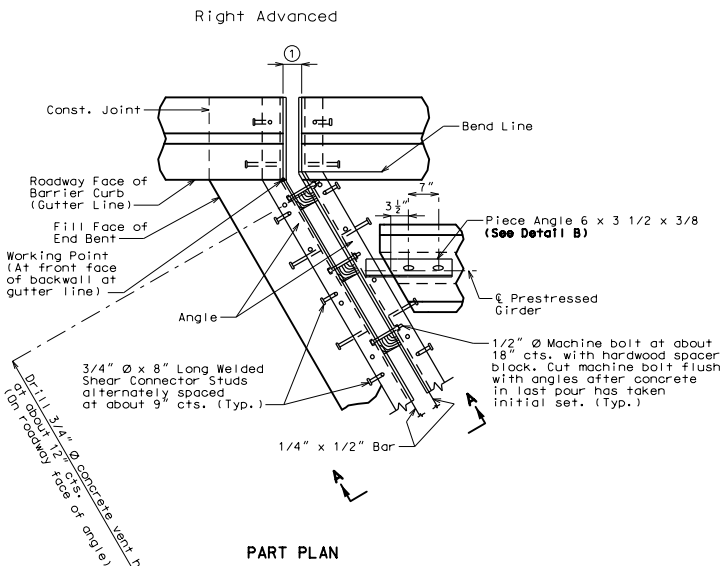

PART PLAN

IF A SEAL IS PRESENT ON THIS SHEET IT HAS BEEN ELECTRONICALLY SEALED AND DATED.

MISSOURI HIGHWAYS AND TRANSPORTATION COMMISSION

MDOT

105 WEST CAPITOL
JEFFERSON CITY, MO 65102
1-888-688-MODOT (1-888-219-6638)