

Concrete for prestressed girders shall be Class A-1 with $f'_c = 8000$ psi and $f'_t = 6500$ psi.

(+) indicates prestressing strand.

Use strands with an initial prestress force of _____ kips.

Prestressing tendons shall be uncoated, seven-wire, low-relaxation strands, 0.6 inch diameter in accordance with AASHTO M 203, Grade 270. Prestensioned members shall be in accordance with Sec 1029.

Girders shall be lifted by devices designed by the fabricator.

At the contractor's option the location for bent-up strands may be varied from that shown. The total number of bent-up strands shall not be changed. One strand tie bar is required for each layer of bent-up strands except at end bents which require one bar on the bottom layer of strands only. No additional payment will be made if additional strand tie bars are required.

Girder top flange shall be steel troweled to a smooth finish for 8" at the edges, as shown. Bond breaker shall be applied to this region only. The center portion shall be rough finished by scarifying the surface transversely with a wire brush, and no laitance shall remain on the surface.

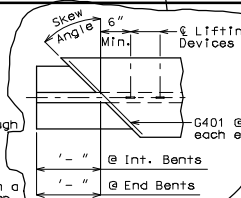

BILL OF REINFORCING STEEL - EACH GIRDER				
NO.	SIZE	#	ACTUAL LENGTH	SHAPE
XXX	G 301	21	2'-11 1/2"	15
2	G 401	XX'-XX"		20
XXX	G 402	2	2'-3"	20

BENDING DIAGRAM	
SHAPE 15 (G301)	SHAPE 20 (G401)
13" 7 1/2" 13"	3'-10 1/2" / cos (skew angle)
	SHAPE 20 (G402)

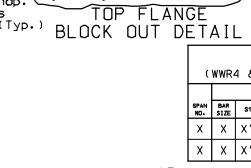
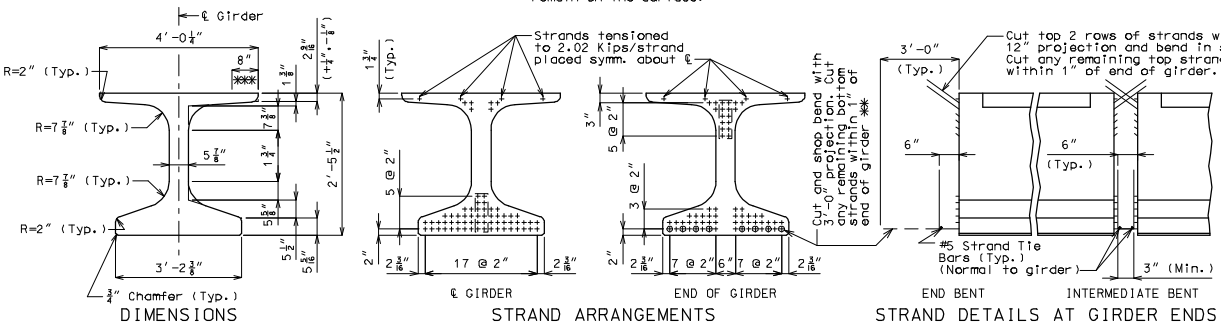

WELED WIRE REINFORCEMENT (WWR4 & WWR5 as shown in Welded Wire Bending Diagrams)																
SPAN NO.	BAR SIZE	#	WWR1				WWR2				WWR3					
			L1	#	BAR SIZE	#	L2	#	BAR SIZE	#	L3	#	BAR SIZE	#		
X	X	X"	X'-X"	X"	X	X"	X'-X"	X"	X	X"	X'-X"	X"	X	X"	X'-X"	X"
X	X	X"	X'-X"	X"	X	X"	X'-X"	X"	X	X"	X'-X"	X"	X	X"	X'-X"	X"

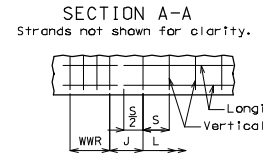
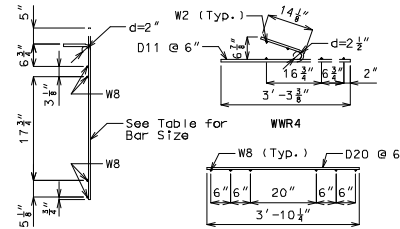
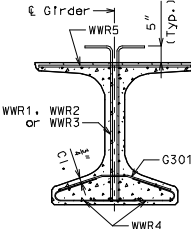
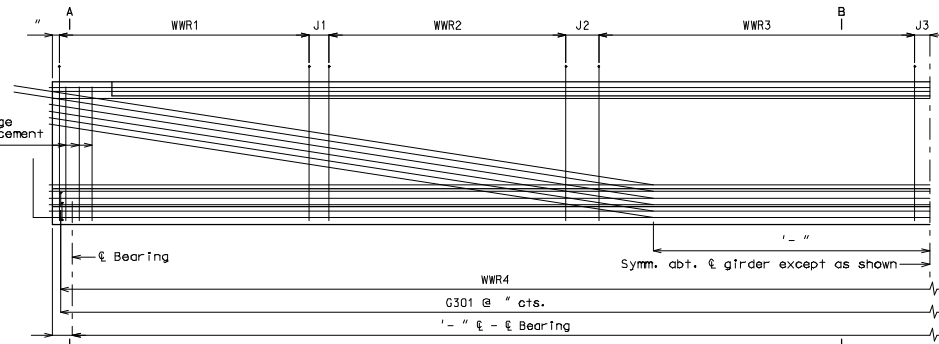
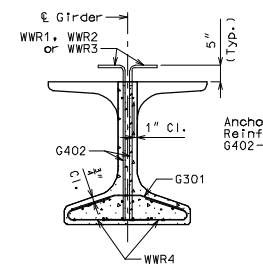

REINFORCING STEEL NOTES:
 Reinforcing steel shall conform to the requirements of AASHTO M 31, Grade 60. Welded Wire Reinforcement (WWR) shall conform to the requirements of AASHTO M 221.
 All dimensions are out to out.
 Hooks and bends shall be in accordance with the CRSI Manual of Standard Practice for Detailing Reinforced Concrete Structures, Stirrup and Tie Dimensions.
 Minimum clearance to reinforcing shall be 1", unless otherwise shown.
 Actual lengths are measured along centerline of bar to the nearest inch.

Cost of 3/4" coil tie rods placed in diaphragms will be considered completely covered by the contract unit price for Prestressed Concrete NU-Girder.
 Coil ties shall be held in place in the forms by slotted wire-setting studs projecting through forms. Studs are to be left in place or replaced with temporary plugs until girders are erected, then replaced by coil tie rods.
 The contractor must provide any temporary intermediate diaphragms and/or bracing necessary to provide lateral and torsional stability for the girders during construction of the concrete slab. The temporary intermediate diaphragms/bracing shall be removed after the concrete slab has attained 75% of its design strength. The cost for furnishing, installing, and removing the temporary intermediate diaphragms and/or bracing shall be considered completely covered by the contract unit price for the Prestressed Concrete NU-Girder.
 For location of coil inserts at slab drains, see Sheet No. ____ & ____
 For location of coil ties, see Sheets No. ____ & ____
 Drilling is not allowed.
 For Girder Cambar Diagram, see Sheet No. ____
 * Length of coil tie rods of exterior girders at end bents = ____.

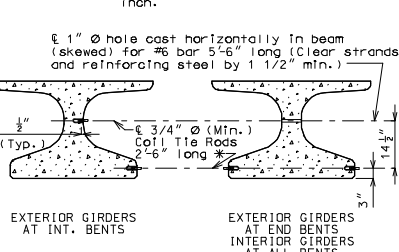
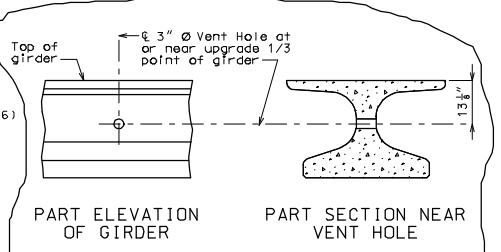
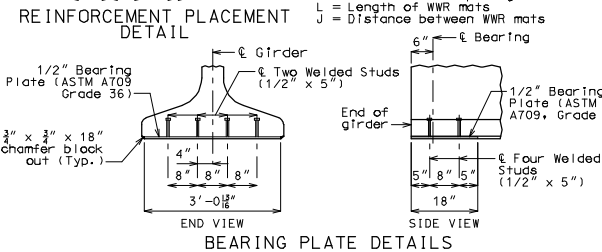

Galvanize the 1/2" bearing plate (ASTM A709 Grade 36) in accordance with ASTM A123.
 Cost of furnishing, galvanizing, and installing the 1/2" bearing plate (ASTM A709 Grade 36) and welded studs in the prestressed girder will be considered completely covered by the contract unit price for Prestressed Concrete NU-Girder.

Place vent holes at or near upgrade 1/3 point of girders and clear reinforcing steel or strands by 1 1/2" minimum and steel intermediate diaphragm bolt connections by 6" minimum.

1" hole cast horizontally in beam (skewed) for #6 bar 5'-6" long (Clear strands and reinforcing steel by 1 1/2" min.)
 3/4" (Typ.)
 3/4" (Min.)
 2'-6" long

THIS MEDIA SHOULD NOT BE CONSIDERED A CERTIFIED DOCUMENT.
 DATE PREPARED: 07/28/2008
 ROUTE: MO
 DISTRICT: BR
 COUNTY: MO
 JOB NO.:
 CONTRACT ID.:
 PROJECT NO.:
 BRIDGE NO.: NU 29
 MISSOURI HIGHWAYS AND TRANSPORTATION COMMISSION
 105 WEST CAPITOL JEFFERSON CITY, MO 65102
 1-888-ASK-MODOT (1-888-275-4636)